

Optocoupler with Phototransistor Output

Order Nos. and Classification table is on sheet 2.

Description

The CNY75(G) series consists of a phototransistor optically coupled to a gallium arsenide infrared-emitting diode in a 6-lead plastic dual inline package.

The elements are mounted on one leadframe using a **coplanar technique**, providing a fixed distance between input and output for highest safety requirements.

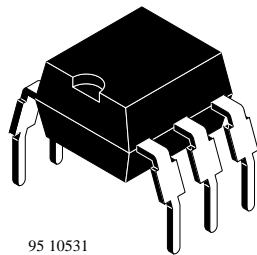

95 10531

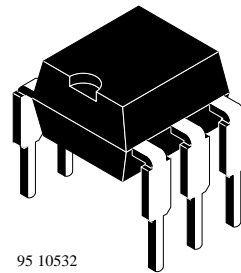

95 10532

Applications

Circuits for safe protective separation against electrical shock according to safety class II (reinforced isolation):

- For application class I - IV at mains voltage ≤ 300 V
- For application class I - III at mains voltage ≤ 600 V according to VDE 0884, table 2, suitable for:

Switch-mode power supplies, computer peripheral interface, microprocessor-system interface, line receiver.



0884

These couplers perform safety functions according to the following equipment standards:

- **VDE 0884**
Optocoupler providing protective separation
- **VDE 0804**
Telecommunication apparatus and data processing
- **VDE 0805/IEC 950/ 60950**
Office machines (applied for reinforced isolation for mains voltages ≤ 400 V_{RMS})
- **VDE 0860/IEC 65**
Safety for mains-operated electronic and related household apparatus

Features

- Approvals:
BSI: BS EN 41003, BS EN 60065 (BS 415)
 BS EN 60950 (BS 7002)
 Certificate number 7081 and 7402
FIMKO (SETI): EN 60950
 Certificate number 41400
Underwriters Laboratory (UL) 1577
 recognized-file No. E-76222
VDE 0884 Certificate number 94778

VDE 0884 related features:

- Rated impulse voltage (transient overvoltage)
 $V_{IOTM} = 6 \text{ kV peak}$
- Isolation test voltage (partial discharge test voltage)
 $V_{pd} = 1.6 \text{ kV}$
- Rated isolation voltage (RMS includes DC)
 $V_{IOWM} = 600 \text{ V}_{RMS}$ (848 V peak)
- Rated recurring peak voltage (repetitive)
 $V_{IORM} = 600 \text{ V}_{RMS}$

- Creepage current resistance according to VDE 0303/IEC 112
 Comparative Tracking Index: **CTI = 275**
- Thickness through insulation $\geq 0.75 \text{ mm}$

General features:

- CTR offered in 3 groups
- Isolation materials according to UL94-VO
- Pollution degree 2
 (DIN/VDE 0110 part 1 resp. IEC 664)
- Climatic classification 55/100/21 (IEC 68 part 1)
- Special construction:
 Therefore extra low coupling capacity
 typical 0.3 pF, high **Common Mode Rejection**
- Low temperature coefficient of CTR
- Coupling System A

Order Schematic

Part Numbers	CTR-Ranking
CNY75A/ CNY75(G)A	63 to 125%
CNY75B/ CNY75(G)B	100 to 200%
CNY75C/ CNY75(G)C	160 to 320%

Suffix: G = Leadform 10.16 mm

Pin Connection

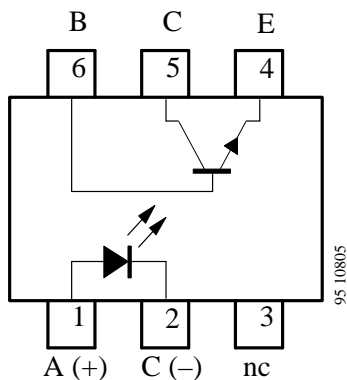

Absolute Maximum Ratings

Input (Emitter)

Parameters	Test Conditions	Symbol	Value	Unit
Reverse voltage		V_R	5	V
Forward current		I_F	60	mA
Forward surge current	$t_p \leq 10 \mu s$	I_{FSM}	3	A
Power dissipation	$T_{amb} \leq 25^\circ C$	P_{tot}	100	mW
Junction temperature		T_j	125	$^\circ C$

Output (Detector)

Parameters	Test Conditions	Symbol	Value	Unit
Collector base voltage		V_{CBO}	90	V
Collector emitter voltage		V_{CEO}	90	V
Emitter collector voltage		V_{ECO}	7	V
Collector current		I_C	50	mA
Collector peak current	$t_p/T = 0.5, t_p \leq 10 \text{ ms}$	I_{CM}	100	mA
Power dissipation	$T_{amb} \leq 25^\circ C$	P_{tot}	150	mW
Junction temperature		T_j	125	$^\circ C$

Coupler

Parameters	Test Conditions	Symbol	Value	Unit
AC isolation test voltage (RMS)		V_{IO}	3.75	kV
Total power dissipation	$T_{amb} \leq 25^\circ C$	P_{tot}	250	mW
Ambient temperature range		T_{amb}	-55 to +100	$^\circ C$
Storage temperature range		T_{stg}	-55 to +125	$^\circ C$
Soldering temperature	2 mm from case, $t \leq 10 \text{ s}$	T_{sd}	260	$^\circ C$

Maximum Safety Ratings¹⁾ (according to VDE 0884)

Input (Emitter)

Parameters	Test Conditions	Symbol	Value	Unit
Forward current		I_{si}	130	mA

Output (Detector)

Parameters	Test Conditions	Symbol	Value	Unit
Power dissipation	$T_{amb} \leq 25^{\circ}\text{C}$	P_{si}	265	mW

Coupler

Parameters	Test Conditions	Symbol	Value	Unit
Rated impulse voltage		V_{IOTM}	6	kV
Safety temperature		T_{si}	150	$^{\circ}\text{C}$

- 1) This device is used for protective separation against electrical shock only within the maximum safety ratings. This must be ensured by using protective circuits in the applications.

Derating Diagram

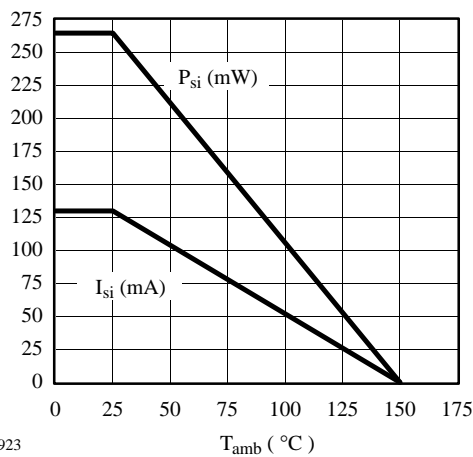

95 10923

Electrical Characteristics

$T_{amb} = 25^{\circ}\text{C}$

Input (Emitter)

Parameters	Test Conditions	Symbol	Min.	Typ.	Max.	Unit
Forward voltage	$I_F = 50 \text{ mA}$	V_F		1.25	1.6	V
Reverse current	$V_R = 6 \text{ V}$	I_R			10	μA
Junction capacitance	$V_R = 0, f = 1 \text{ MHz}$	C_j		50		pF

Output (Detector)

Parameters	Test Conditions	Symbol	Min.	Typ.	Max.	Unit
Collector base voltage	$I_C = 100 \mu\text{A}$	V_{CBO}	90			V
Collector emitter voltage	$I_C = 1 \text{ mA}$	V_{CEO}	90			V
Emitter collector voltage	$I_E = 100 \mu\text{A}$	V_{ECO}	7			V
Collector emitter cut-off current	$V_{CE} = 20 \text{ V}, I_F = 0$	I_{CEO}			150	nA

Coupler

Parameters	Test Conditions	Type	Symbol	Min.	Typ.	Max.	Unit
AC isolation test voltage (RMS)	$f = 50 \text{ Hz}, t = 1 \text{ s}$		V_{IO}	3.75			kV
Collector emitter saturation voltage	$I_F = 10 \text{ mA}, I_C = 1 \text{ mA}$		V_{CEsat}			0.3	V
Cut-off frequency	$V_{CE} = 5 \text{ V}, I_F = 10 \text{ mA}, R_L = 100 \Omega$		f_c		110		kHz
Coupling capacitance	$f = 1 \text{ MHz}$		C_k		0.3		pF
I_C/I_F	$V_{CE} = 5 \text{ V}, I_F = 1 \text{ mA}$	CNY75A CNY75B CNY75C	CTR CTR CTR	0.15 0.3 0.6			
I_C/I_F	$V_{CE} = 5 \text{ V}, I_F = 10 \text{ mA}$	CNY75A CNY75B CNY75C	CTR CTR CTR	0.63 1 1.6		1.25 2 3.2	

Switching Characteristics (Typical Values)

$V_S = 5\text{ V}$

Type	$R_L = 100\ \Omega$ (see figure 1)							$R_L = 1\text{ k}\Omega$ (see figure 2)		
	$t_d[\mu\text{s}]$	$t_r[\mu\text{s}]$	$t_{on}[\mu\text{s}]$	$t_s[\mu\text{s}]$	$t_f[\mu\text{s}]$	$t_{off}[\mu\text{s}]$	$I_C[\text{mA}]$	$t_{on}[\mu\text{s}]$	$t_{off}[\mu\text{s}]$	$I_F[\text{mA}]$
CNY75A CNY75(G)A	2.0	2.5	4.5	0.3	2.7	3.0	10	10.0	25.0	10
CNY75B CNY75(G)B	2.5	3.0	5.5	0.3	3.7	4.0	10	16.5	20.0	10
CNY75C CNY75(G)C	2.8	4.2	7.0	0.3	4.7	5.0	10	11	37.5	10

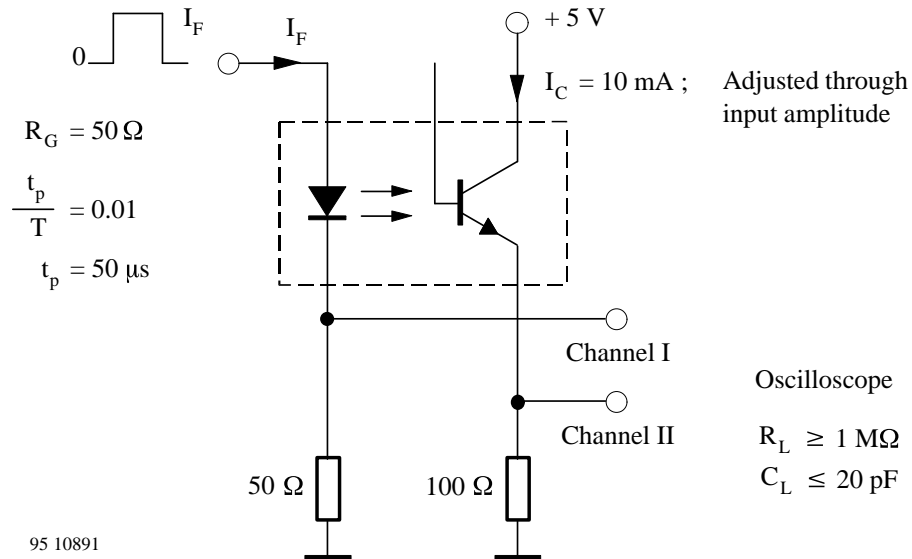

Figure 1. Test circuit, non-saturated operation

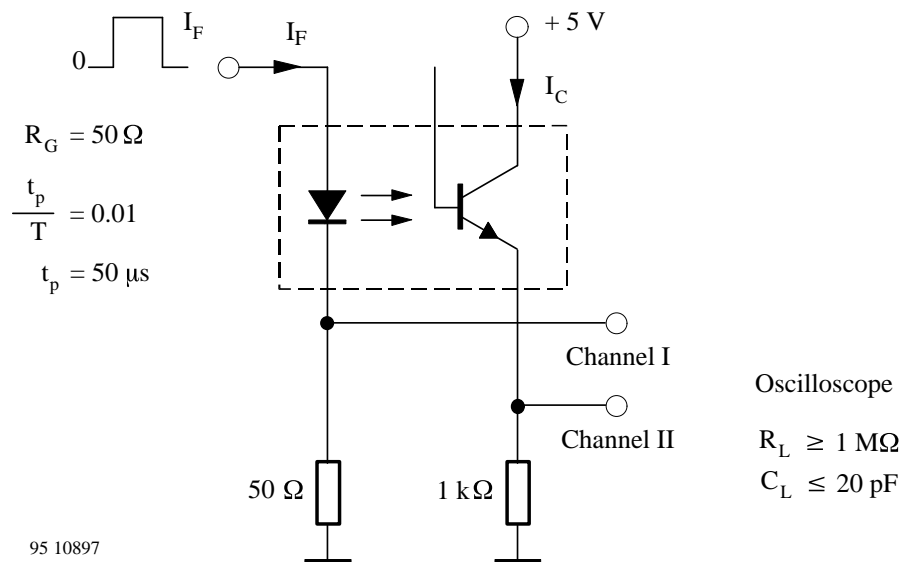

Figure 2. Test circuit, saturated operation

Insulation Rated Parameters (according to VDE 0884)

Parameters		Test Conditions	Symbol	Min.	Typ.	Max.	Unit
Partial discharge test voltage	Routine test	100%, $t_{\text{test}} = 1 \text{ s}$	V_{pd}	1.6			kV
	Lot test (sample test)	$t_{\text{Tr}} = 10 \text{ s}$, $t_{\text{test}} = 60 \text{ s}$ (see figure 3)	V_{IOPTM}	6			kV
			V_{pd}	1.3			kV
Insulation resistance		$V_{\text{IO}} = 500 \text{ V}$	R_{IO}	10^{12}			Ω
		$V_{\text{IO}} = 500 \text{ V}$, $T_{\text{amb}} \leq 100^\circ\text{C}$	R_{IO}	10^{11}			Ω
		$V_{\text{IO}} = 500 \text{ V}$, $T_{\text{amb}} \leq 150^\circ\text{C}$ (construction test only)	R_{IO}	10^9			Ω

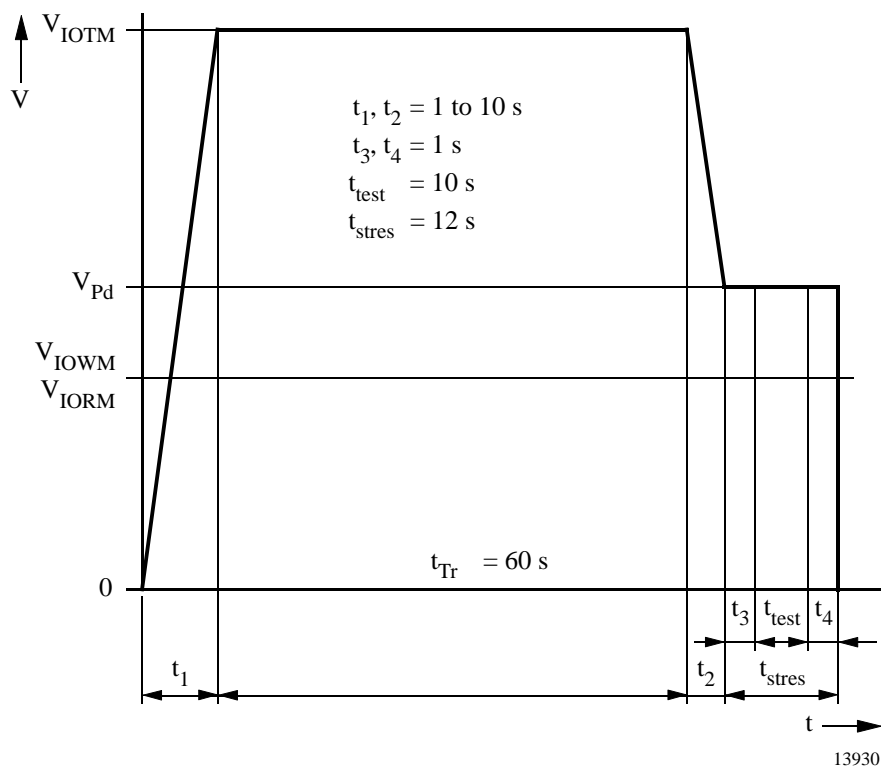

Figure 3. Test pulse diagram for sample test according to DIN VDE 0884

Typical Characteristics ($T_{amb} = 25^{\circ}\text{C}$, unless otherwise specified)

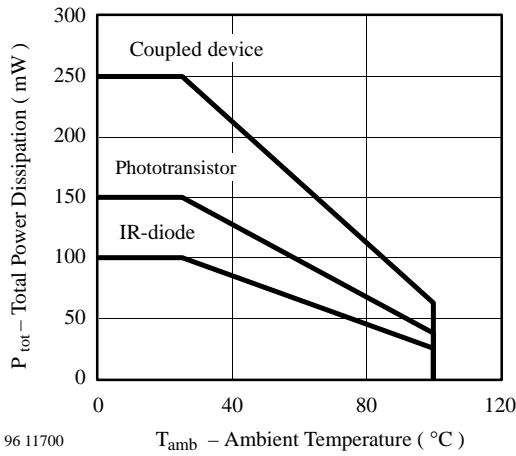

Figure 4. Total Power Dissipation vs. Ambient Temperature

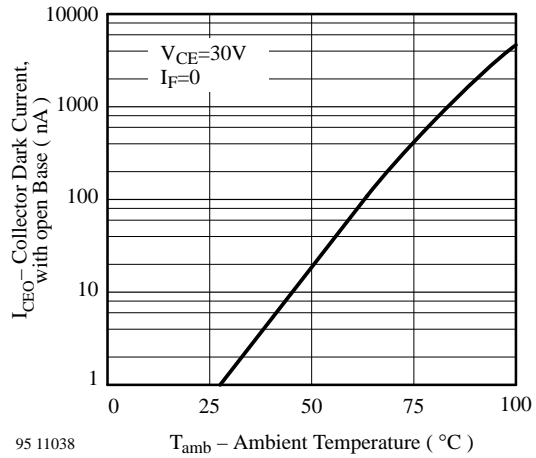

Figure 7. Collector Dark Current vs. Ambient Temperature

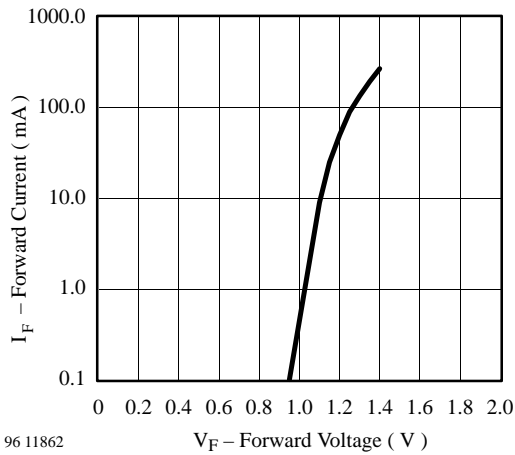

Figure 5. Forward Current vs. Forward Voltage

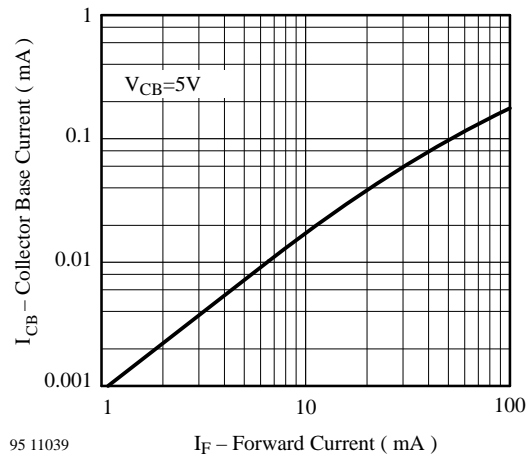

Figure 8. Collector Base Current vs. Forward Current

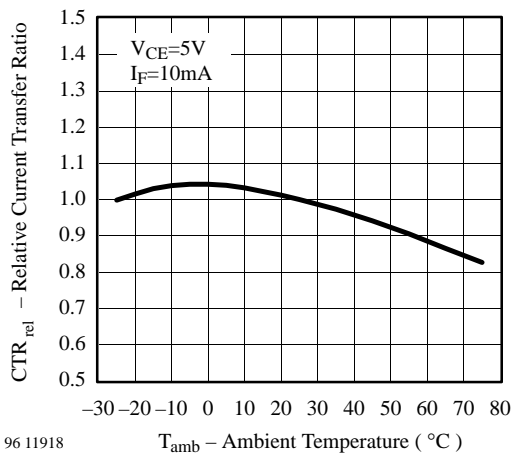

Figure 6. Rel. Current Transfer Ratio vs. Ambient Temperature

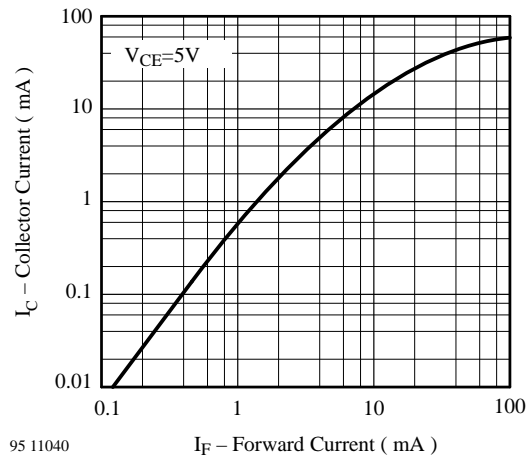

Figure 9. Collector Current vs. Forward Current

Typical Characteristics ($T_{amb} = 25^{\circ}C$, unless otherwise specified)

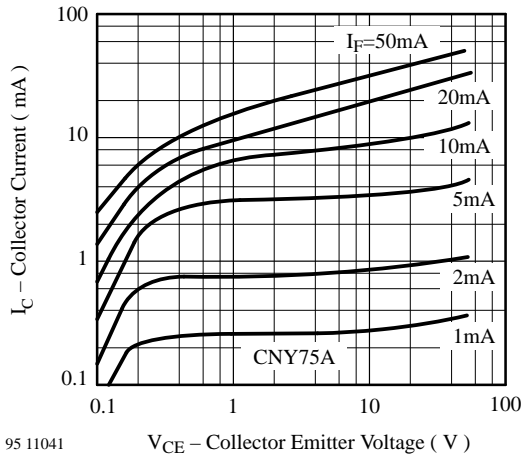

Figure 10. Collector Current vs. Collector Emitter Voltage

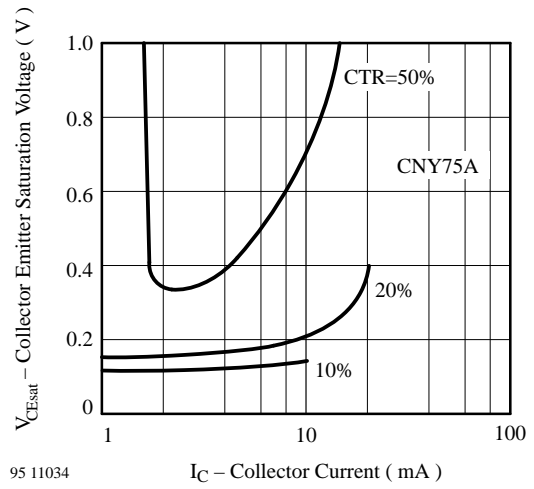

Figure 13. Collector Emitter Sat. Voltage vs. Collector Current

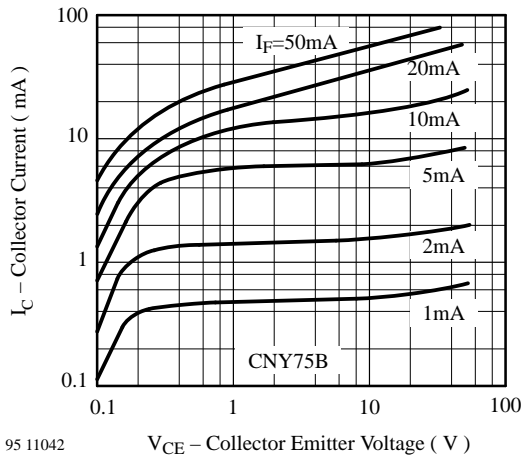

Figure 11. Collector Current vs. Collector Emitter Voltage

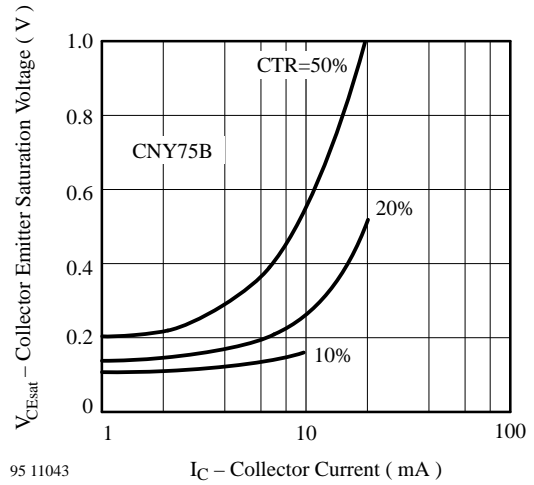

Figure 14. Collector Emitter Sat. Voltage vs. Collector Current

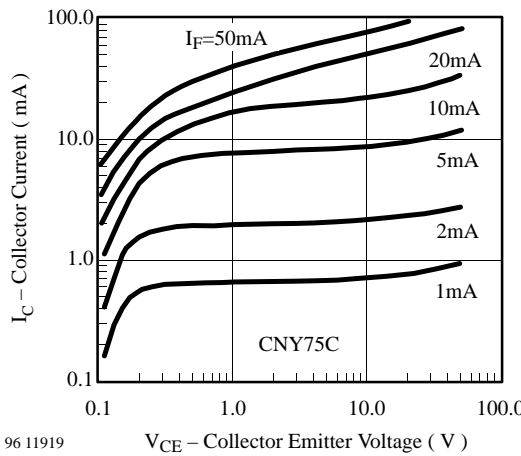

Figure 12. Collector Current vs. Collector Emitter Voltage

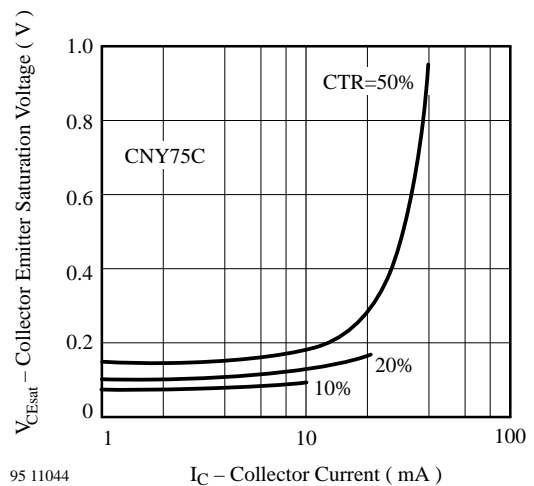

Figure 15. Collector Emitter Sat. Voltage vs. Collector Current

Typical Characteristics ($T_{amb} = 25^{\circ}\text{C}$, unless otherwise specified)

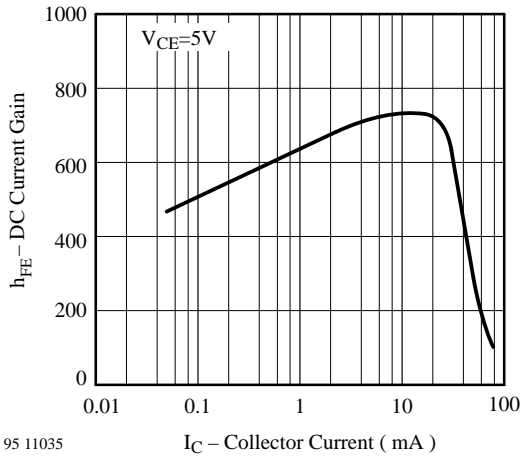

Figure 16. DC Current Gain vs. Collector Current

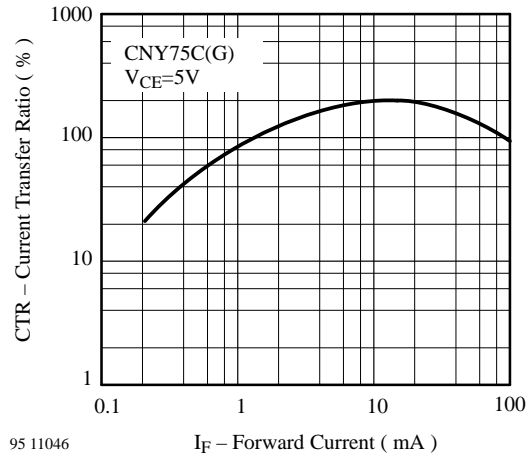

Figure 19. Current Transfer Ratio vs. Forward Current

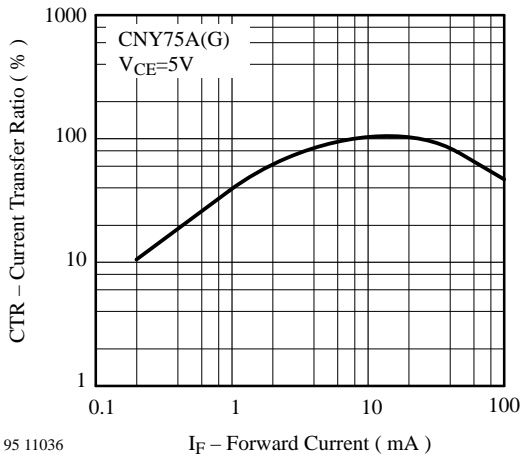

Figure 17. Current Transfer Ratio vs. Forward Current

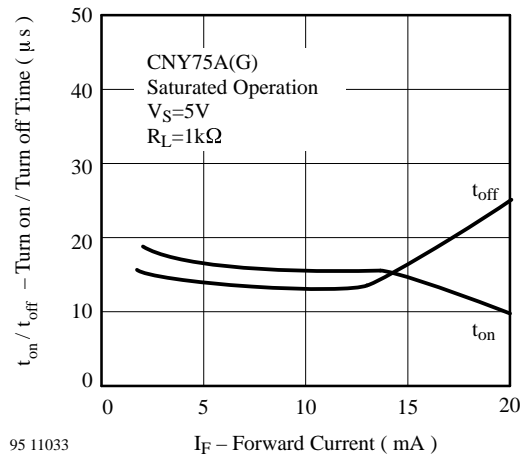

Figure 20. Turn on / off Time vs. Forward Current

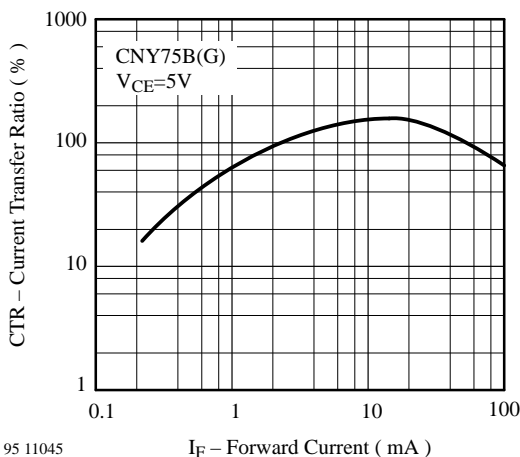

Figure 18. Current Transfer Ratio vs. Forward Current

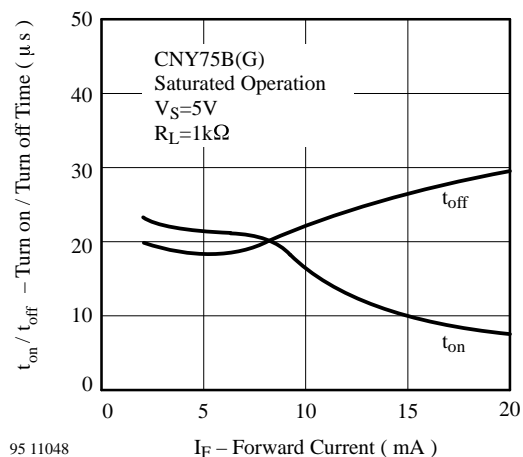

Figure 21. Turn on / off Time vs. Forward Current

Typical Characteristics ($T_{amb} = 25^{\circ}\text{C}$, unless otherwise specified)

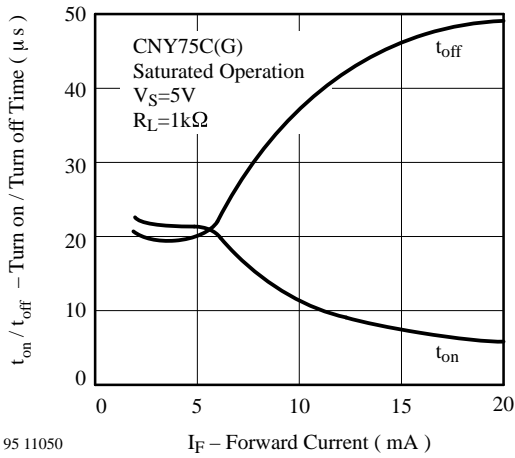

Figure 22. Turn on / off Time vs. Forward Current

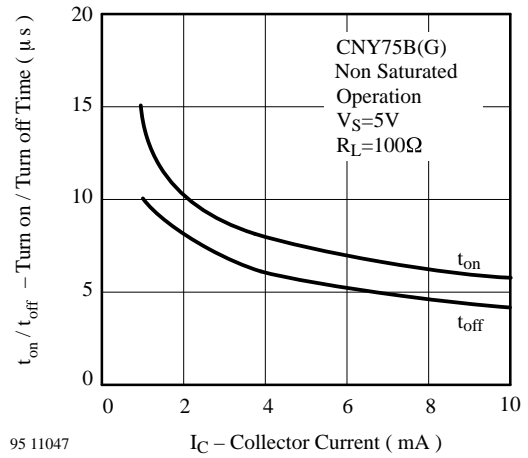

Figure 24. Turn on / off Time vs. Collector Current

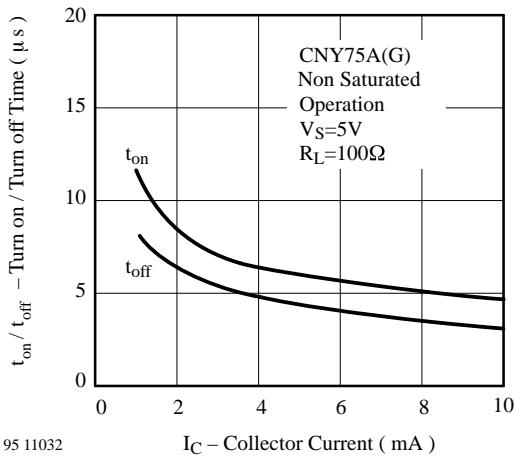

Figure 23. Turn on / off Time vs. Collector Current

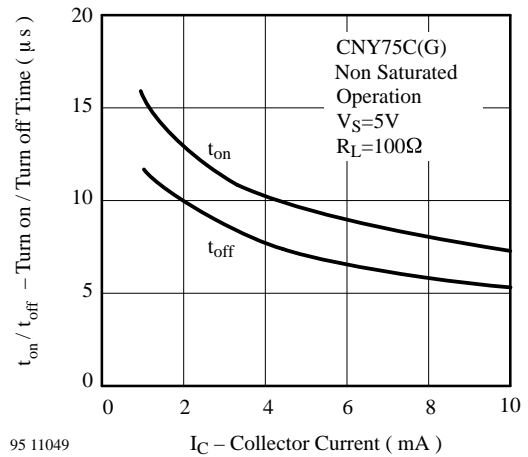
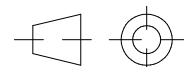
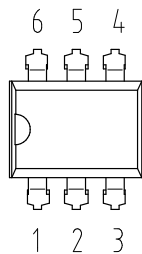
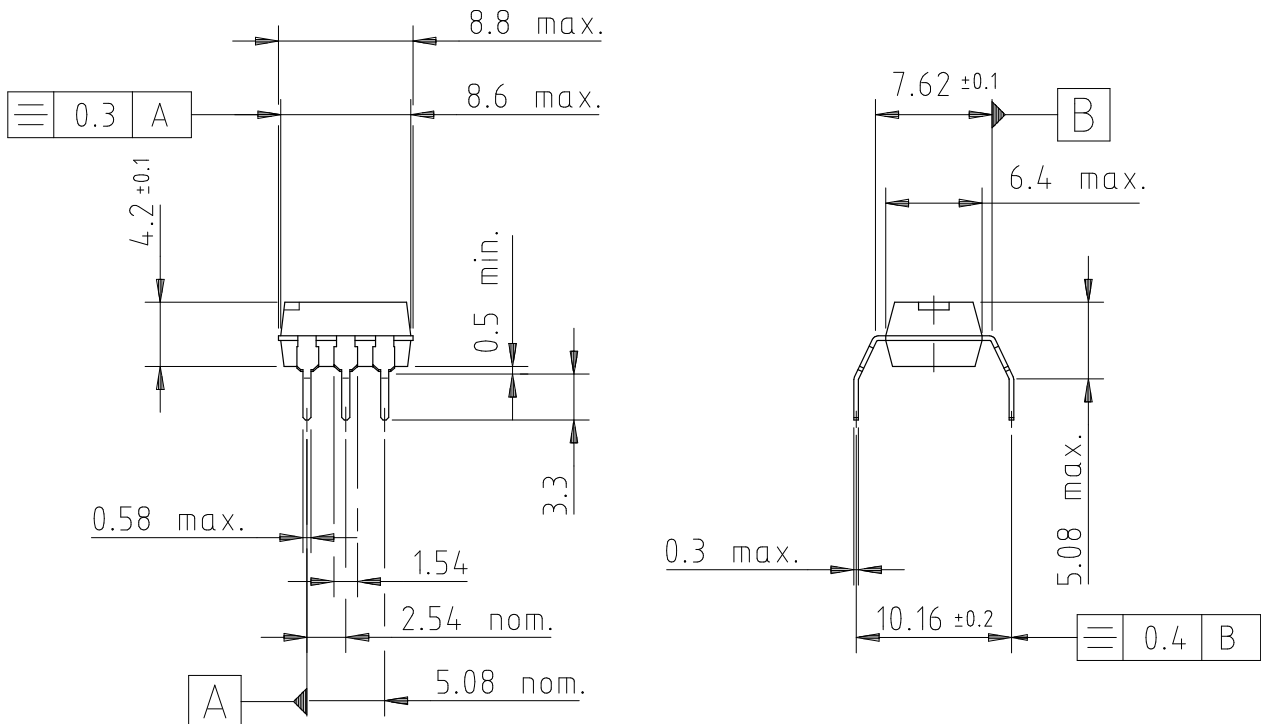

Figure 25. Turn on / off Time vs. Collector Current

CNY75(G) Series

Dimensions in mm

Leadform 10.16. mm (G-type)



technical drawings
according to DIN
specifications

14771

weight: ca. 0.50 g
creeping distance: $\cong 8$ mm
air path: $\cong 8$ mm

after mounting on PC board

Dimensions in mm

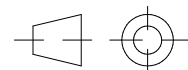
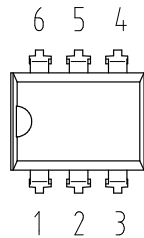
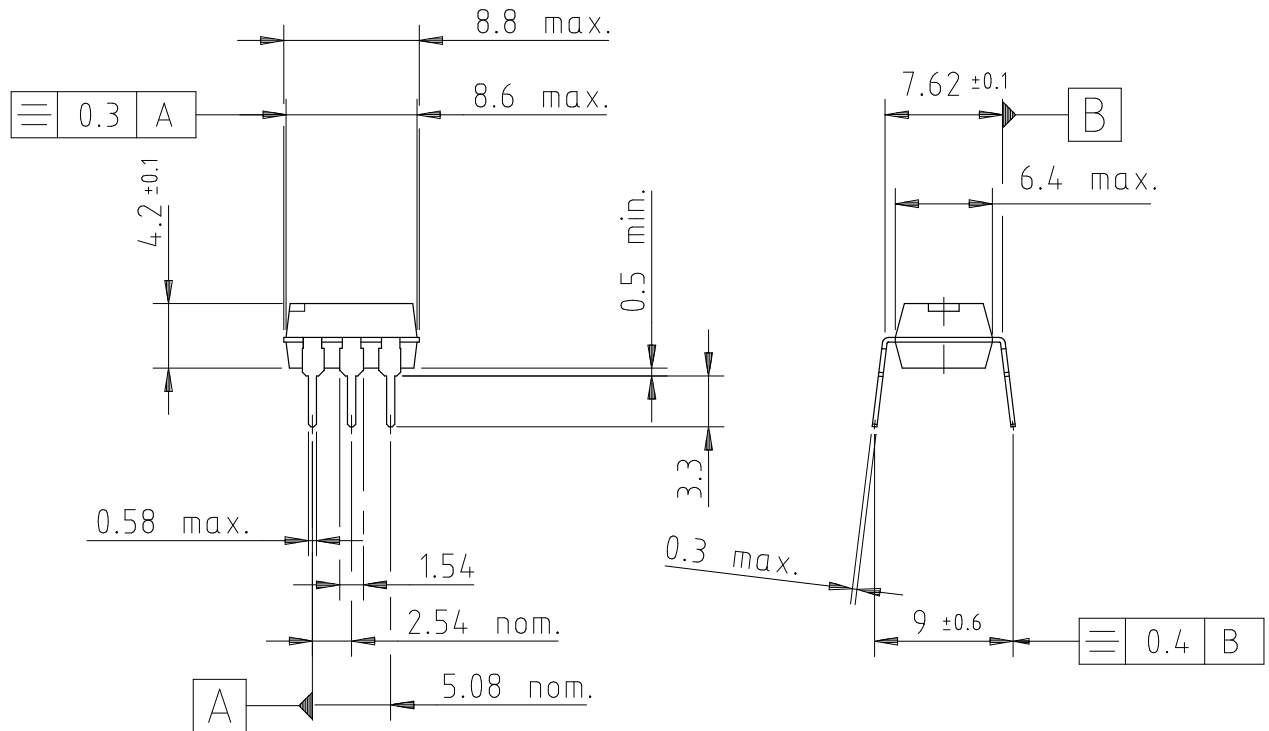

technical drawings
according to DIN
specifications

14770

weight: 0.50 g
creeping distance: ≥ 6 mm
air path: ≥ 6 mm

after mounting on PC board

Ozone Depleting Substances Policy Statement

It is the policy of **TEMIC TELEFUNKEN microelectronic GmbH** to

1. Meet all present and future national and international statutory requirements.
2. Regularly and continuously improve the performance of our products, processes, distribution and operating systems with respect to their impact on the health and safety of our employees and the public, as well as their impact on the environment.

It is particular concern to control or eliminate releases of those substances into the atmosphere which are known as ozone depleting substances (ODSs).

The Montreal Protocol (1987) and its London Amendments (1990) intend to severely restrict the use of ODSs and forbid their use within the next ten years. Various national and international initiatives are pressing for an earlier ban on these substances.

TEMIC TELEFUNKEN microelectronic GmbH semiconductor division has been able to use its policy of continuous improvements to eliminate the use of ODSs listed in the following documents.

1. Annex A, B and list of transitional substances of the Montreal Protocol and the London Amendments respectively
2. Class I and II ozone depleting substances in the Clean Air Act Amendments of 1990 by the Environmental Protection Agency (EPA) in the USA
3. Council Decision 88/540/EEC and 91/690/EEC Annex A, B and C (transitional substances) respectively.

TEMIC can certify that our semiconductors are not manufactured with ozone depleting substances and do not contain such substances.

We reserve the right to make changes to improve technical design and may do so without further notice.

Parameters can vary in different applications. All operating parameters must be validated for each customer application by the customer. Should the buyer use TEMIC products for any unintended or unauthorized application, the buyer shall indemnify TEMIC against all claims, costs, damages, and expenses, arising out of, directly or indirectly, any claim of personal damage, injury or death associated with such unintended or unauthorized use.

TEMIC TELEFUNKEN microelectronic GmbH, P.O.B. 3535, D-74025 Heilbronn, Germany
Telephone: 49 (0)7131 67 2831, Fax number: 49 (0)7131 67 2423