

**H11G1
H11G2
H11G3**

DESCRIPTION

The H11GX series are photodarlington-type optically coupled optocouplers. These devices have a gallium arsenide infrared emitting diode coupled with a silicon darlington connected phototransistor which has an integral base-emitter resistor to optimize elevated temperature characteristics.

FEATURES

- High BV_{CEO}
 - Minimum 100 V for H11G1
 - Minimum 80 V for H11G2
 - Minimum 55 V for H11G3
- High sensitivity to low input current
Minimum 500 percent CTR at $I_F = 1$ mA
- Low leakage current at elevated temperature
(maximum 100 μ A at 80°C)
- Underwriters Laboratory (UL) recognized File# E90700

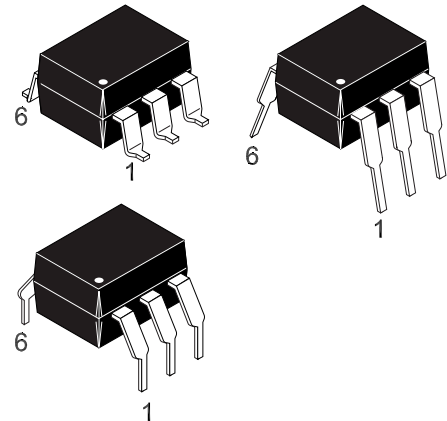

APPLICATIONS

- CMOS logic interface
- Telephone ring detector
- Low input TTL interface
- Power supply isolation
- Replace pulse transformer

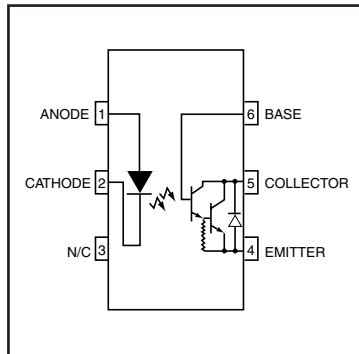

NOTE

All dimensions are in inches (millimeters)

ABSOLUTE MAXIMUM RATINGS			
Parameter	Symbol	Value	Units
TOTAL DEVICE			
Storage Temperature	T_{STG}	-55 to +150	°C
Operating Temperature	T_{OPR}	-55 to +100	°C
Lead Solder Temperature	T_{SOL}	260 for 10 sec	°C
Total Device Power Dissipation @ $T_A = 25^\circ\text{C}$	P_D	260	mW
Derate above 25°C		3.5	mW/°C
Input-Output Isolation Voltage	V_{ISO}	5300	Vac(rms)
EMITTER			
Forward Input Current	I_F	60	mA
Reverse Input Voltage	V_R	6.0	V
Forward Current - Peak (1 μ s pulse, 300pps)	$I_{F(pk)}$	3.0	A
LED Power Dissipation @ $T_A = 25^\circ\text{C}$	P_D	100	mW
Derate above 25°C		1.8	mW/°C
DETECTOR			
Collector-Emitter Voltage	V_{CEO}	100	V
H11G1			
H11G2			
H11G3	55		
Detector Power Dissipation @ $T_A = 25^\circ\text{C}$	P_D	200	mW
Derate above 25°C		2.67	mW/°C

H11G1, H11G2, H11G3
ELECTRICAL CHARACTERISTICS ($T_A = 25^\circ\text{C}$ Unless otherwise specified.)

INDIVIDUAL COMPONENT CHARACTERISTICS

Characteristic	Test Conditions	Symbol	Device	Min	Typ**	Max	Unit
EMITTER							
Forward Voltage	($I_F = 10\text{ mA}$)	V_F	ALL		1.3	1.50	V
Forward Voltage Temp. Coefficient		$\frac{\Delta V_F}{\Delta T_A}$	ALL		-1.8		mV/°C
Reverse Breakdown Voltage	($I_R = 10\text{ }\mu\text{A}$)	BV_R	ALL	3.0	25		V
Junction Capacitance	($V_F = 0\text{ V}$, $f = 1\text{ MHz}$)	C_J	ALL		50		pF
	($V_F = 1\text{ V}$, $f = 1\text{ MHz}$)		ALL		65		pF
Reverse Leakage Current	($V_R = 3.0\text{ V}$)	I_R	ALL		0.001	10	μA
DETECTOR							
Breakdown Voltage Collector to Emitter	($I_C = 1.0\text{ mA}$, $I_F = 0$)	BV_{CEO}	H11G1	100			V
			H11G2	80			
			H11G3	55			
Collector to Base	($I_C = 100\text{ }\mu\text{A}$)	BV_{CBO}	H11G1	100			
			H11G2	80			
			H11G3	55			
Emitter to Base		BV_{EBO}	ALL	7	10		
Leakage Current Collector to Emitter	($V_{CE} = 80\text{ V}$, $I_F = 0$)	I_{CEO}	H11G1			100	nA
	($V_{CE} = 60\text{ V}$, $I_F = 0$)		H11G2				
	($V_{CE} = 30\text{ V}$, $I_F = 0$)		H11G3				
	($V_{CE} = 80\text{ V}$, $I_F = 0$, $T_A = 80^\circ\text{C}$)		H11G1			100	μA
	($V_{CE} = 60\text{ V}$, $I_F = 0$, $T_A = 80^\circ\text{C}$)		H11G2				

TRANSFER CHARACTERISTICS

DC Characteristic	Test Conditions	Symbol	Device	Min	Typ**	Max	Unit
EMITTER							
Current Transfer Ratio Collector to Emitter	($I_F = 10\text{ mA}$, $V_{CE} = 1\text{ V}$)	CTR	H11G1/2	100 (1000)			mA (%)
	($I_F = 1\text{ mA}$, $V_{CE} = 5\text{ V}$)		H11G1/2	5 (500)			
			H11G3	2 (200)			
Saturation Voltage	($I_F = 16\text{ mA}$, $I_C = 50\text{ mA}$)	$V_{CE(SAT)}$	H11G1/2		0.85	1.0	V
	($I_F = 1\text{ mA}$, $I_C = 1\text{ mA}$)		H11G1/2		0.75	1.0	
	($I_F = 20\text{ mA}$, $I_C = 50\text{ mA}$)		H11G3		0.85	1.2	

TRANSFER CHARACTERISTICS

Characteristic	Test Conditions	Symbol	Device	Min	Typ**	Max	Unit
SWITCHING TIMES							
Turn-on Time	($R_L = 100\text{ }\Omega$, $I_F = 10\text{ mA}$)	t_{on}	ALL		5		μs
Turn-off Time	($V_{CE} = 5\text{ V}$) Pulse Width $\leq 300\text{ }\mu\text{s}$, $f \leq 30\text{ Hz}$)	t_{off}	ALL		100		

** All typical values at $T_A = 25^\circ\text{C}$

H11G1, H11G2, H11G3

Fig. 1 Output Current vs. Input Current

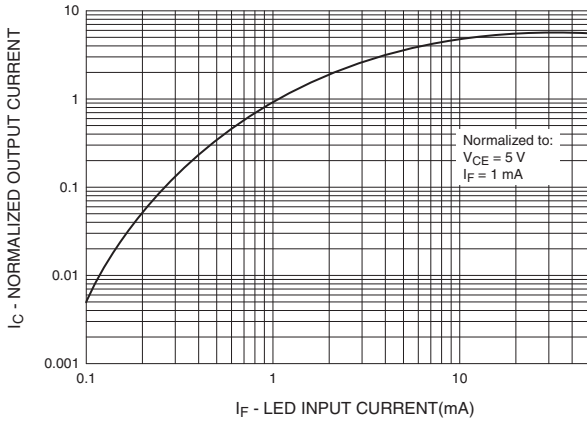

Fig. 2 Normalized Output Current vs. Temperature

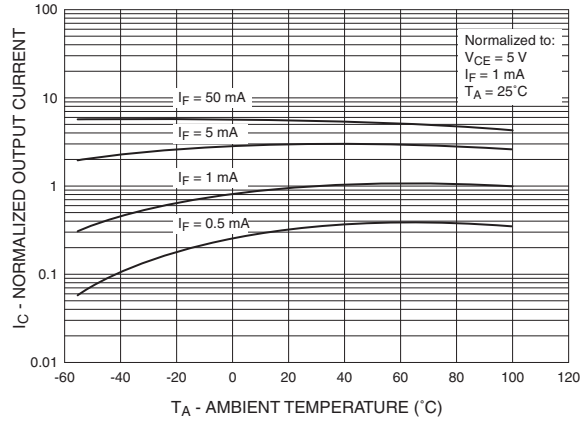

Fig. 3 Output Current vs. Collector - Emitter Voltage

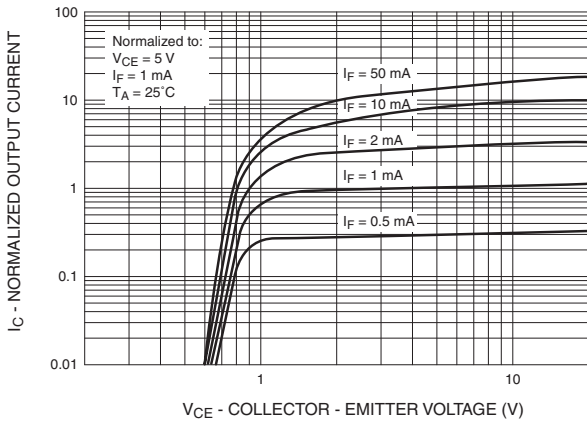

Fig. 4 Collector-Emitter Dark Current vs. Ambient Temperature

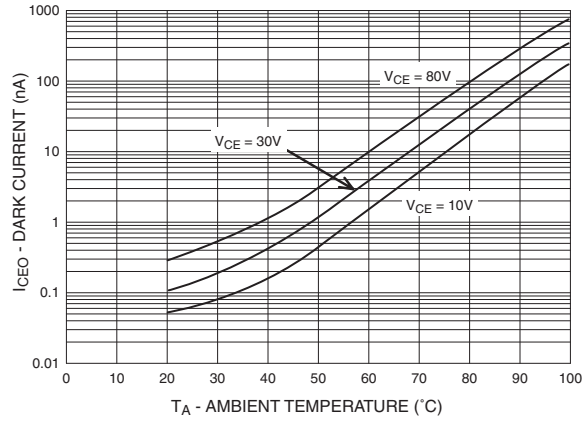
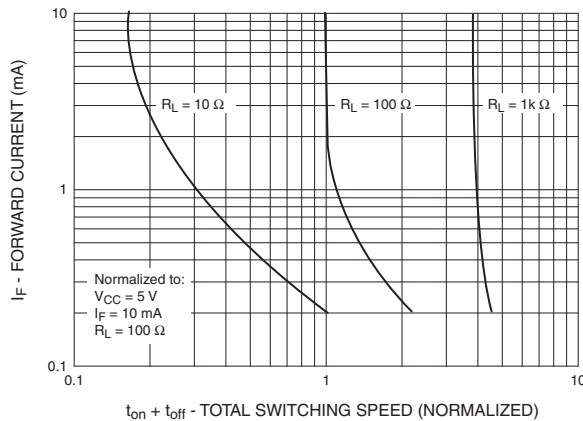

Fig. 5 Input Current vs. Total Switching Speed (Typical Values)



H11G1, H11G2, H11G3

ORDERING INFORMATION

Option	Order Entry Identifier	Description
S	.S	Surface Mount Lead Bend
SD	.SD	Surface Mount; Tape and reel
W	.W	0.4" Lead Spacing
300	.300	VDE 0884
300W	.300W	VDE 0884, 0.4" Lead Spacing
3S	.3S	VDE 0884, Surface Mount
3SD	.3SD	VDE 0884, Surface Mount, Tape & Reel

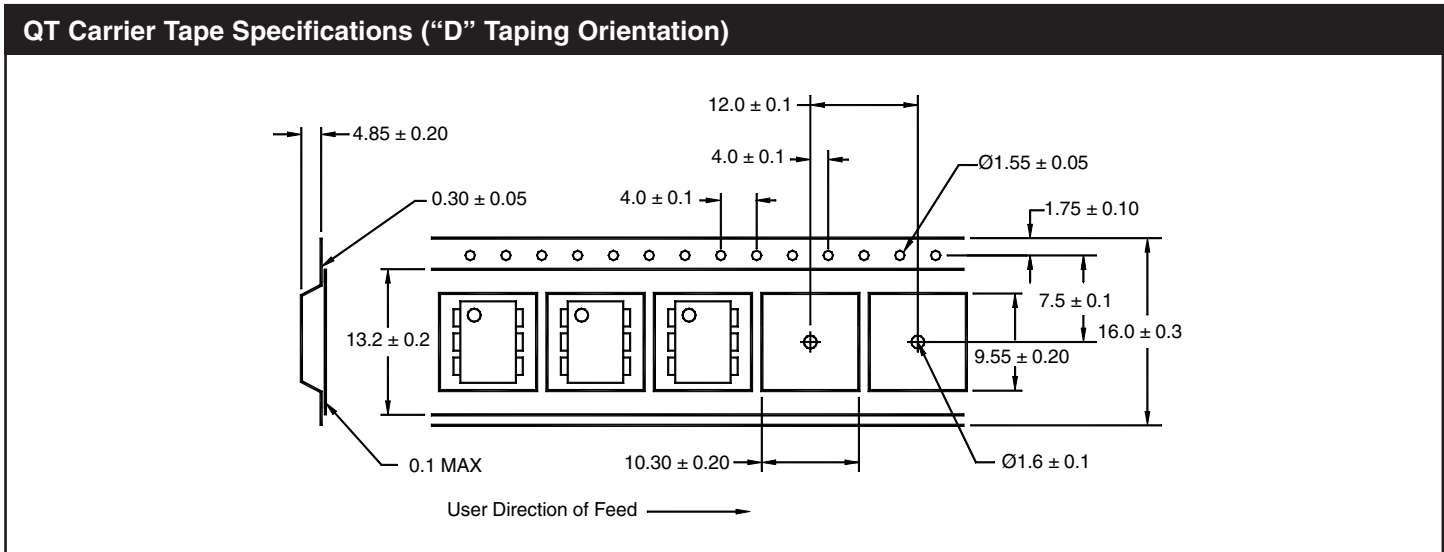

NOTE

All dimensions are in millimeters

DISCLAIMER

FAIRCHILD SEMICONDUCTOR RESERVES THE RIGHT TO MAKE CHANGES WITHOUT FURTHER NOTICE TO ANY PRODUCTS HEREIN TO IMPROVE RELIABILITY, FUNCTION OR DESIGN. FAIRCHILD DOES NOT ASSUME ANY LIABILITY ARISING OUT OF THE APPLICATION OR USE OF ANY PRODUCT OR CIRCUIT DESCRIBED HEREIN; NEITHER DOES IT CONVEY ANY LICENSE UNDER ITS PATENT RIGHTS, NOR THE RIGHTS OF OTHERS.

LIFE SUPPORT POLICY

FAIRCHILD'S PRODUCTS ARE NOT AUTHORIZED FOR USE AS CRITICAL COMPONENTS IN LIFE SUPPORT DEVICES OR SYSTEMS WITHOUT THE EXPRESS WRITTEN APPROVAL OF THE PRESIDENT OF FAIRCHILD SEMICONDUCTOR CORPORATION. As used herein:

1. Life support devices or systems are devices or systems which, (a) are intended for surgical implant into the body, or (b) support or sustain life, and (c) whose failure to perform when properly used in accordance with instructions for use provided in the labeling, can be reasonably expected to result in a significant injury of the user.
2. A critical component in any component of a life support device or system whose failure to perform can be reasonably expected to cause the failure of the life support device or system, or to affect its safety or effectiveness.