

LM561A – 5630 Middle Power LED



Introduction

Features

- View Angle: 120 °
- Precondition : JEDEC Level 2a
- Dimension : 5.6 x 3.0 x 0.95 mm
- ESD withstand Voltage : up to ± 5 KV [HBM]

Applications

- INDOOR LIGHTING : Ambient Light, LED tube, Down light, LED bulbs and Ceiling Light

SAMSUNG ELECTRONICS

95, Samsung2-Ro, Giheung-Gu,
Yongin-City, Gyeonggi-Do 446-711, KOREA



Contents

1. Product Code Information	-----	3
2. Luminous Flux Characteristics	-----	10
3. Characteristics	-----	13
4. Typical Characteristics Graph	-----	15
5. Outline Drawing & Dimension	-----	23
6. Reliability Test Items & Conditions	-----	24
7. Solder Conditions	-----	25
8. Tape & Reel	-----	26
9. Label Structure	-----	28
10. Packing Structure	-----	29
11. Precaution For Use	-----	31
12. Hazard Substance Analysis Report	-----	34
Revision History	-----	54



1. Product Code Information

1) Luminous Intensity Bins ($T_s = 25^\circ\text{C}$)

Nominal CCT	Product Code	Flux Rank	Sorting Condition $I_m @50\text{mA}$	
			Intensity Bin	Flux Range (cd)
2700K	SPMWHT5225D5WAW0S0 SPMWHT5225D5WAWMS0 SPMWHT5225D5WAWHS0	S0	S1	4.68 ~ 5.55
			S2	5.55 ~ 6.41
			S3	6.4 ~ 7.28
3000K	SPMWHT5225D5WAV0S0 SPMWHT5225D5WAVMS0 SPMWHT5225D5WAVHS0	S0	S1	4.97 ~ 5.84
			S2	5.84 ~ 6.71
			S3	6.71 ~ 7.58
3500K	SPMWHT5225D5WAU0S0 SPMWHT5225D5WAUMS0 SPMWHT5225D5WAUHS0	S0	S1	5.10 ~ 6.00
			S2	6.00 ~ 6.90
			S3	6.90 ~ 7.80
4000K	SPMWHT5225D5WAT0S0 SPMWHT5225D5WATMS0 SPMWHT5225D5WATHS0	S0	S1	5.20 ~ 6.14
			S2	6.14 ~ 7.08
			S3	7.08 ~ 8.02
5000K	SPMWHT5225D5WAR0S0 SPMWHT5225D5WARMS0	S0	S1	5.30 ~ 6.24
			S2	6.24 ~ 7.18
			S3	7.18 ~ 8.12
5700K	SPMWHT5225D5WAQ0S0 SPMWHT5225D5WAQMS0	S0	S1	5.20 ~ 6.13
			S2	6.13 ~ 7.07
			S3	7.07 ~ 8.00
6500K	SPMWHT5225D5WAP0S0 SPMWHT5225D5WAPMS0	S0	S1	5.10 ~ 6.03
			S2	6.03 ~ 6.96
			S3	6.96 ~ 7.89

Notes:

1) SAMSUNG ELECTRONICS maintains a tolerance of $\pm 5\%$ on Luminous Intensity measurements.



2) Luminous Flux Bins ($T_s = 25^\circ\text{C}$)

Nominal CCT	Product Code	Flux Rank	Sorting Condition $I_m @50\text{mA}$	
			Flux Bin	Flux Range (lm)
2700K	SPMWHT5225D5WAW0S0 SPMWHT5225D5WAWMS0 SPMWHT5225D5WAWHS0	S0	S1	14.02 ~ 16.61
			S2	16.61 ~ 19.21
			S3	19.21 ~ 21.80
3000K	SPMWHT5225D5WAV0S0 SPMWHT5225D5WAVMS0 SPMWHT5225D5WAVHS0	S0	S1	14.89 ~ 17.49
			S2	17.49 ~ 20.10
			S3	20.10 ~ 22.70
3500K	SPMWHT5225D5WAU0S0 SPMWHT5225D5WAUMS0 SPMWHT5225D5WAUHS0	S0	S1	15.27 ~ 17.97
			S2	17.97 ~ 20.67
			S3	20.67 ~ 23.36
4000K	SPMWHT5225D5WAT0S0 SPMWHT5225D5WATMS0 SPMWHT5225D5WATHS0	S0	S1	15.57 ~ 18.39
			S2	18.39 ~ 21.20
			S3	21.20 ~ 24.02
5000K	SPMWHT5225D5WAR0S0 SPMWHT5225D5WARMS0	S0	S1	15.87 ~ 18.69
			S2	18.69 ~ 21.50
			S3	21.50 ~ 24.32
5700K	SPMWHT5225D5WAQ0S0 SPMWHT5225D5WAQMS0	S0	S1	15.57 ~ 18.37
			S2	18.37 ~ 21.17
			S3	21.17 ~ 23.97
6500K	SPMWHT5225D5WAP0S0 SPMWHT5225D5WAPMS0	S0	S1	15.27 ~ 18.06
			S2	18.06 ~ 20.84
			S3	20.84 ~ 23.63

Notes: Luminous Flux(Φ_v , lm) values are representative reference only

3) Color Bins ($T_s = 25^\circ\text{C}$)

1) Color Binning

Nominal CCT	Product Code	Color Rank	Chromaticity Bins
2700K	SPMWHT5225D5WAW0S0	W0(Whole bin)	W1, W2, W3, W4, W5, W6, W7, W8, W9, WA, WB, WC, WD, WE, WF, WG
	SPMWHT5225D5WAWMS0	WM(Quater bin)	W6, W7, WA, WB
	SPMWHT5225D5WAWHS0	WH(Half bin)	W5, W6, W7, W8, W9, WA, WB, WC
3000K	SPMWHT5225D5WAV0S0	V0(Whole bin)	V1, V2, V3, V4, V5, V6, V7, V8, V9, VA, VB, VC, VD, VE, VF, VG
	SPMWHT5225D5WAVMS0	VM(Quater bin)	V6, V7, VA, VB
	SPMWHT5225D5WAVHS0	VH(Half bin)	V5, V6, V7, V8, V9, VA, VB, VC
3500K	SPMWHT5225D5WAU0S0	U0(Whole bin)	U1, U2, U3, U4, U5, U6, U7, U8, U9, UA, UB, UC, UD, UE, UF, UG
	SPMWHT5225D5WAUMS0	UM(Quater bin)	U6, U7, UA, UB
	SPMWHT5225D5WAUHS0	UH(Half bin)	U5, U6, U7, U8, U9, UA, UB, UC
4000K	SPMWHT5225D5WAT0S0	T0(Whole bin)	T1, T2, T3, T4, T5, T6, T7, T8, T9, TA, TB, TC, TD, TE, TF, TG
	SPMWHT5225D5WATMS0	TM(Quater bin)	T6, T7, TA, TB
	SPMWHT5225D5WATHS0	TH(Half bin)	T5, T6, T7, T8, T9, TA, TB, TC
5000K	SPMWHT5225D5WAR0S0	R0(Whole bin)	R1, R2, R3, R4, R5, R6, R7, R8
	SPMWHT5225D5WARMS0	RM(Quater bin)	R1, R2, R3, R4
5700K	SPMWHT5225D5WAQ0S0	Q0(Whole bin)	Q1, Q2, Q3, Q4, Q5, Q6, Q7, Q8
	SPMWHT5225D5WAQMS0	QM(Quater bin)	Q1, Q2, Q3, Q4
6500K	SPMWHT5225D5WAP0S0	P0(Whole bin)	P1, P2, P3, P4, P5, P6, P7, P8
	SPMWHT5225D5WAPMS0	PM(Quater bin)	P1, P2, P3, P4

2) Chromaticity Region & Coordinates

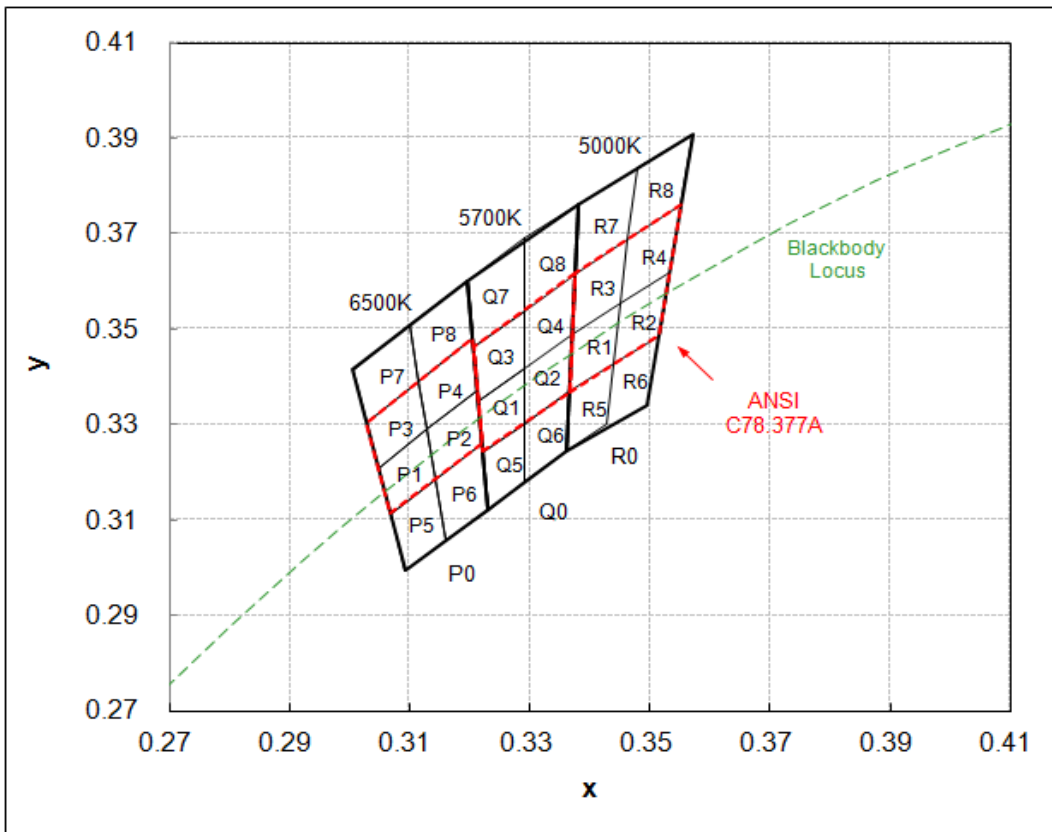
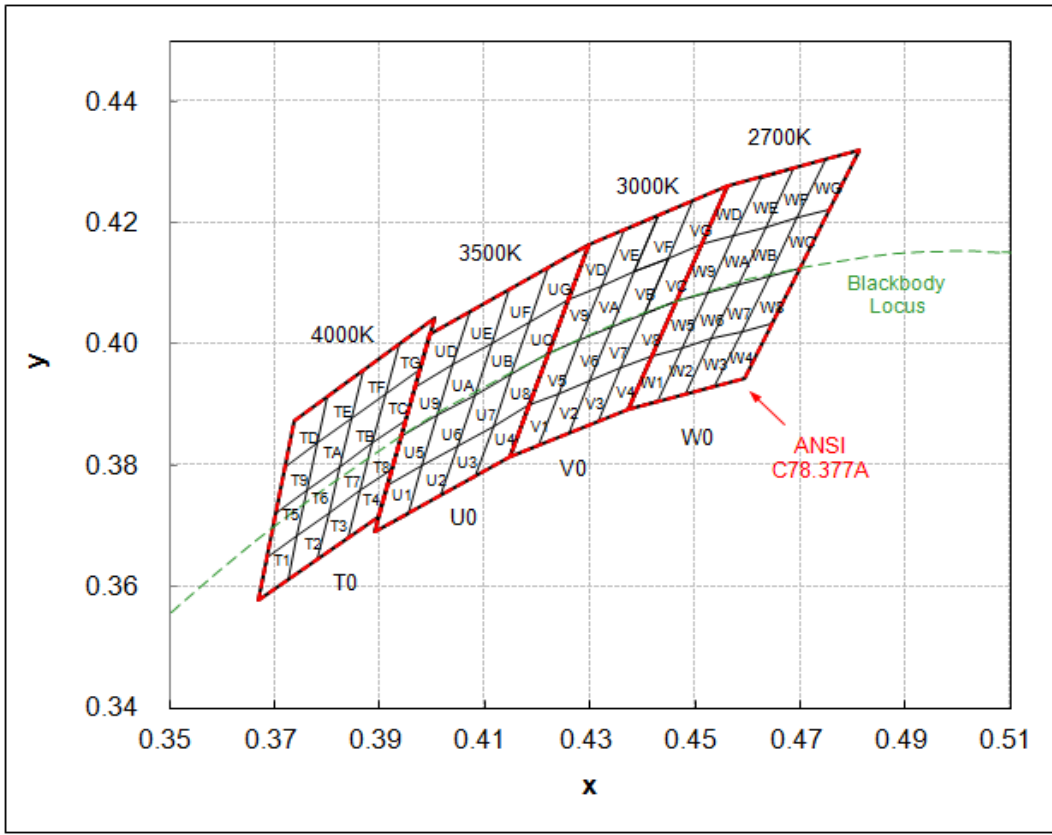



2) Chromaticity Region & Coordinates (Continued)

Region	CIE X	CIE Y	Region	CIE X	CIE Y
W rank (2700K)					
W1	0.4373	0.3893	W9	0.4465	0.4071
	0.4418	0.3981		0.4513	0.4164
	0.4475	0.3994		0.4573	0.4178
	0.4428	0.3906		0.4523	0.4085
W2	0.4428	0.3906	WA	0.4523	0.4085
	0.4475	0.3994		0.4573	0.4178
	0.4532	0.4008		0.4634	0.4193
	0.4483	0.3919		0.4582	0.4099
W3	0.4483	0.3919	WB	0.4582	0.4099
	0.4532	0.4008		0.4634	0.4193
	0.4589	0.4021		0.4695	0.4207
	0.4538	0.3931		0.4641	0.4112
W4	0.4538	0.3931	WC	0.4641	0.4112
	0.4589	0.4021		0.4695	0.4207
	0.4646	0.4034		0.4756	0.4221
	0.4593	0.3944		0.4700	0.4126
W5	0.4418	0.3981	WD	0.4513	0.4164
	0.4465	0.4071		0.4562	0.4260
	0.4523	0.4085		0.4624	0.4274
	0.4475	0.3994		0.4573	0.4178
W6	0.4475	0.3994	WE	0.4573	0.4178
	0.4523	0.4085		0.4624	0.4274
	0.4582	0.4099		0.4687	0.4289
	0.4532	0.4008		0.4634	0.4193
W7	0.4532	0.4008	WF	0.4634	0.4193
	0.4582	0.4099		0.4687	0.4289
	0.4641	0.4112		0.4750	0.4304
	0.4589	0.4021		0.4695	0.4207
W8	0.4589	0.4021	WG	0.4695	0.4207
	0.4641	0.4112		0.4750	0.4304
	0.4700	0.4126		0.4813	0.4319
	0.4646	0.4034		0.4756	0.4221

Region	CIE X	CIE Y	Region	CIE X	CIE Y
V rank (3000K)					
V1	0.4147	0.3814	V9	0.4221	0.3984
	0.4183	0.3898		0.4259	0.4073
	0.4242	0.3919		0.4322	0.4096
	0.4203	0.3833		0.4281	0.4006
V2	0.4203	0.3833	VA	0.4281	0.4006
	0.4242	0.3919		0.4322	0.4096
	0.4300	0.3939		0.4385	0.4119
	0.4259	0.3853		0.4342	0.4028
V3	0.4259	0.3853	VB	0.4342	0.4028
	0.4300	0.3939		0.4385	0.4119
	0.4359	0.3960		0.4449	0.4141
	0.4316	0.3873		0.4403	0.4049
V4	0.4316	0.3873	VC	0.4403	0.4049
	0.4359	0.3960		0.4449	0.4141
	0.4418	0.3981		0.4513	0.4164
	0.4373	0.3893		0.4465	0.4071
V5	0.4183	0.3898	VD	0.4259	0.4073
	0.4221	0.3984		0.4299	0.4165
	0.4281	0.4006		0.4364	0.4188
	0.4242	0.3919		0.4322	0.4096
V6	0.4242	0.3919	VE	0.4322	0.4096
	0.4281	0.4006		0.4364	0.4188
	0.4342	0.4028		0.4430	0.4212
	0.4300	0.3939		0.4385	0.4119
V7	0.4300	0.3939	VF	0.4385	0.4119
	0.4342	0.4028		0.4430	0.4212
	0.4403	0.4049		0.4496	0.4236
	0.4359	0.3960		0.4449	0.4141
V8	0.4359	0.3960	VG	0.4449	0.4141
	0.4403	0.4049		0.4496	0.4236
	0.4465	0.4071		0.4562	0.4260
	0.4418	0.3981		0.4513	0.4164



2) Chromaticity Region & Coordinates (Continued)

Region	CIE X	CIE Y	Region	CIE X	CIE Y
U rank (3500K)					
U1	0.3889	0.3690	U9	0.3941	0.3848
	0.3915	0.3768		0.3968	0.3930
	0.3981	0.3800		0.4040	0.3966
	0.3953	0.3720		0.4010	0.3882
U2	0.3953	0.3720	UA	0.4010	0.3882
	0.3981	0.3800		0.4040	0.3966
	0.4048	0.3832		0.4113	0.4001
	0.4017	0.3751		0.4080	0.3916
U3	0.4017	0.3751	UB	0.4080	0.3916
	0.4048	0.3832		0.4113	0.4001
	0.4116	0.3865		0.4186	0.4037
	0.4082	0.3782		0.4150	0.3950
U4	0.4082	0.3782	UC	0.4150	0.3950
	0.4116	0.3865		0.4186	0.4037
	0.4183	0.3898		0.4259	0.4073
	0.4147	0.3814		0.4221	0.3984
U5	0.3915	0.3768	UD	0.3968	0.3930
	0.3941	0.3848		0.3996	0.4015
	0.4010	0.3882		0.4071	0.4052
	0.3981	0.3800		0.4040	0.3966
U6	0.3981	0.3800	UE	0.4040	0.3966
	0.4010	0.3882		0.4071	0.4052
	0.4080	0.3916		0.4146	0.4089
	0.4048	0.3832		0.4113	0.4001
U7	0.4048	0.3832	UF	0.4113	0.4001
	0.4080	0.3916		0.4146	0.4089
	0.4150	0.3950		0.4222	0.4127
	0.4116	0.3865		0.4186	0.4037
U8	0.4116	0.3865	UG	0.4186	0.4037
	0.4150	0.3950		0.4222	0.4127
	0.4221	0.3984		0.4299	0.4165
	0.4183	0.3898		0.4259	0.4073

Region	CIE X	CIE Y	Region	CIE X	CIE Y
T rank (4000K)					
T1	0.367	0.3578	T9	0.3702	0.3722
	0.3726	0.3612		0.3763	0.376
	0.3744	0.3685		0.3782	0.3837
	0.3686	0.3649		0.3719	0.3797
T2	0.3726	0.3612	TA	0.3763	0.3760
	0.3783	0.3646		0.3825	0.3798
	0.3804	0.3721		0.3847	0.3877
	0.3744	0.3685		0.3782	0.3837
T3	0.3783	0.3646	TB	0.3825	0.3798
	0.3840	0.3681		0.3887	0.3836
	0.3863	0.3758		0.3912	0.3917
	0.3804	0.3721		0.3847	0.3877
T4	0.384	0.3681	TC	0.3887	0.3837
	0.3898	0.3716		0.395	0.3875
	0.3924	0.3794		0.3978	0.3958
	0.3863	0.3758		0.3912	0.3917
T5	0.3686	0.3649	TD	0.3719	0.3797
	0.3744	0.3685		0.3782	0.3837
	0.3763	0.376		0.3802	0.3916
	0.3702	0.3722		0.3736	0.3874
T6	0.3744	0.3685	TE	0.3782	0.3837
	0.3804	0.3721		0.3847	0.3877
	0.3825	0.3798		0.3869	0.3958
	0.3763	0.376		0.3802	0.3916
T7	0.3804	0.3721	TF	0.3847	0.3877
	0.3863	0.3758		0.3912	0.3917
	0.3887	0.3836		0.3937	0.4001
	0.3825	0.3798		0.3869	0.3958
T8	0.3863	0.3758	TG	0.3912	0.3917
	0.3924	0.3794		0.3978	0.3958
	0.395	0.3875		0.4006	0.4044
	0.3887	0.3836		0.3937	0.4001



2) Chromaticity Region & Coordinates (Continued)

Region	CIE X	CIE Y	Region	CIE X	CIE Y
R rank (5000K)					
R1	0.3371	0.3490	R5	0.3366	0.3369
	0.3451	0.3554		0.3440	0.3428
	0.3440	0.3427		0.3429	0.3307
	0.3366	0.3369		0.3361	0.3245
R2	0.3451	0.3554	R6	0.3440	0.3428
	0.3533	0.3620		0.3515	0.3487
	0.3515	0.3487		0.3495	0.3339
	0.3440	0.3427		0.3429	0.3307
R3	0.3376	0.3616	R7	0.3381	0.3762
	0.3463	0.3687		0.3480	0.3840
	0.3451	0.3554		0.3463	0.3687
	0.3371	0.3490		0.3376	0.3616
R4	0.3463	0.3687	R8	0.3480	0.3840
	0.3551	0.3760		0.3571	0.3907
	0.3533	0.3620		0.3551	0.3760
	0.3451	0.3554		0.3463	0.3687
Q rank (5700K)					
Q1	0.3215	0.3350	Q5	0.3222	0.3243
	0.3290	0.3417		0.3290	0.3300
	0.3290	0.3300		0.3290	0.3180
	0.3222	0.3243		0.3231	0.3120
Q2	0.3290	0.3417	Q6	0.3290	0.3300
	0.3371	0.3490		0.3366	0.3369
	0.3366	0.3369		0.3361	0.3245
	0.3290	0.3300		0.3290	0.3180
Q3	0.3207	0.3462	Q7	0.3196	0.3602
	0.3290	0.3538		0.3290	0.3690
	0.3290	0.3417		0.3290	0.3538
	0.3215	0.3350		0.3207	0.3462
Q4	0.3290	0.3538	Q8	0.3290	0.3690
	0.3376	0.3616		0.3381	0.3762
	0.3371	0.3490		0.3376	0.3616
	0.3290	0.3417		0.3290	0.3538

Region	CIE X	CIE Y	Region	CIE X	CIE Y
P rank (6500K)					
P1	0.3068	0.3113	P5	0.3093	0.2993
	0.3144	0.3186		0.3161	0.3059
	0.3130	0.3290		0.3144	0.3186
	0.3048	0.3207		0.3068	0.3113
P2	0.3144	0.3186	P6	0.3161	0.3059
	0.3221	0.3261		0.3231	0.3120
	0.3213	0.3373		0.3221	0.3261
	0.3130	0.3290		0.3144	0.3186
P3	0.3048	0.3207	P7	0.3028	0.3304
	0.3130	0.3290		0.3115	0.3391
	0.3115	0.3391		0.3099	0.3509
	0.3028	0.3304		0.3005	0.3415
P4	0.3130	0.3290	P8	0.3115	0.3391
	0.3213	0.3373		0.3205	0.3481
	0.3205	0.3481		0.3196	0.3602
	0.3115	0.3391		0.3099	0.3509

Notes:

SAMSUNG ELECTRONICS maintains ± 0.005 tolerance of CCx, CCy



2. Luminous Flux Characteristics ($T_s = 25^\circ\text{C}$)

Nominal CCT	If(mA)	Vf(V)	Power(W)	Flux(lm)	Lm/W
2700K	50 (Sorting Current)	2.91	0.15	16.7	114
	60	2.95	0.18	19.8	112
	65	2.97	0.19	21.2	110
	70	2.99	0.21	22.7	108
	80	3.03	0.24	26.0	107
	90	3.07	0.28	29.0	105
	100	3.10	0.31	31.9	103
	110	3.14	0.35	34.8	101
	120	3.17	0.38	37.6	99
	130	3.21	0.42	40.4	97
	140	3.24	0.45	43.1	95
	150	3.27	0.49	45.8	93
3000K	50 (Sorting Current)	2.91	0.15	17.2	118
	60	2.95	0.18	20.5	116
	65	2.97	0.19	21.9	113
	70	2.99	0.21	23.5	112
	80	3.03	0.24	26.9	111
	90	3.07	0.28	30.0	109
	100	3.10	0.31	33.0	106
	110	3.14	0.35	36.0	104
	120	3.17	0.38	38.9	102
	130	3.21	0.42	41.7	100
	140	3.24	0.45	44.5	98
	150	3.27	0.49	47.3	96
3500K	50 (Sorting Current)	2.91	0.15	17.8	122
	60	2.95	0.18	21.2	120
	65	2.97	0.19	22.6	117
	70	2.99	0.21	24.2	116
	80	3.03	0.24	27.7	115
	90	3.07	0.28	31.0	112
	100	3.10	0.31	34.1	110
	110	3.14	0.35	37.1	108
	120	3.17	0.38	40.1	106
	130	3.21	0.42	43.1	104
	140	3.24	0.45	46.0	102



Nominal CCT	If(mA)	Vf(V)	Power(W)	Flux(lm)	Lm/W
4000K	50 (Sorting Current)	2.91	0.14	18.3	126
	60	2.95	0.17	21.8	123
	65	2.97	0.19	23.3	121
	70	2.99	0.2	25.0	119
	80	3.02	0.24	28.6	118
	90	3.06	0.27	31.9	116
	100	3.10	0.31	35.2	113
	110	3.14	0.35	38.3	111
	120	3.17	0.38	41.4	109
	130	3.20	0.42	44.5	107
	140	3.24	0.45	47.5	105
	150	3.27	0.49	50.4	103
	5000K	50 (Sorting Current)	2.91	0.15	18.7
60		2.95	0.18	22.3	126
65		2.97	0.19	23.8	123
70		2.99	0.21	25.5	122
80		3.03	0.24	29.2	121
90		3.07	0.28	32.6	118
100		3.10	0.31	35.9	116
110		3.14	0.35	39.1	113
120		3.17	0.38	42.3	111
130		3.21	0.42	45.4	109
140		3.24	0.45	48.4	107
150		3.27	0.49	51.4	105
5700K		50 (Sorting Current)	2.91	0.14	18.5
	60	2.95	0.17	22.1	124
	65	2.97	0.19	23.6	122
	70	2.99	0.2	25.3	120
	80	3.02	0.24	28.9	119
	90	3.06	0.27	32.3	116
	100	3.10	0.31	35.5	114
	110	3.14	0.35	38.7	112
	120	3.17	0.38	41.8	109
	130	3.21	0.42	44.9	107
	140	3.24	0.45	47.9	105
	150	3.27	0.49	50.9	103



Nominal CCT	If(mA)	Vf(V)	Power(W)	Flux(lm)	Lm/W
6700K	50 (Sorting Current)	2.91	0.14	18.4	126
	60	2.95	0.17	22.0	123
	65	2.97	0.19	23.4	121
	70	2.99	0.2	25.1	120
	80	3.02	0.24	28.8	118
	90	3.06	0.27	32.1	116
	100	3.10	0.31	35.3	113
	110	3.14	0.35	38.5	111
	120	3.17	0.38	41.6	109
	130	3.21	0.42	44.7	107
	140	3.24	0.45	47.7	105
	150	3.27	0.49	50.7	103

Notes:

Luminous Flux(Φ_v , lm) values are representative reference only

3. Characteristics

1) Absolute Maximum Rating

Item	Symbol	Rating	Condition
Operating temperature range	T _{op}	-40°C ~ +85°C	-
Storage temperature range	T _{stg}	-40°C ~ +100°C	-
LED junction temperature	T _J	110°C	-
Forward Current	I _F	150 mA	-
Peak Pulsed Forward Current	I _{FP}	300 mA	Duty 1/10 pulse width 10ms
Thermal resistance	R _{th, j-s}	17.7°C/W	Junction to solder point
Assembly Process Temperature	-	260°C, < 10sec	-
ESD	-	5kV	HBM

2) Electro-optical Characteristics

Item	Unit	CCT	Rank	Min	Typ	Max	
Forward voltage ¹⁾ (@50 mA, T _s = 25°C)	V	-	WA	A1	2.8	-	2.9
				A2	2.9	-	3.0
				A3	3.0	-	3.1
				A4	3.1	-	3.2
				A5	3.2	-	3.3
Luminous Intensity ²⁾ (@50 mA, T _s = 25°C)	cd	2700K	S0	S1	4.68	-	5.55
				S2	5.55	-	6.41
				S3	6.41	-	7.28
		3000K	S0	S1	4.97	-	5.84
				S2	5.84	-	6.71
				S3	6.71	-	7.58
		3500K	S0	S1	5.10	-	6.00
				S2	6.00	-	6.90
				S3	6.90	-	7.80
		4000K	S0	S1	5.20	-	6.14
				S2	6.14	-	7.08
				S3	7.08	-	8.02
		5000K	S0	S1	5.30	-	6.24
				S2	6.24	-	7.18
				S3	7.18	-	8.12
		5700K	S0	S1	5.20	-	6.13
				S2	6.13	-	7.07
				S3	7.07	-	8.00
		6500K	S0	S1	5.10	-	6.03
				S2	6.03	-	6.96
				S3	6.96	-	7.89

2) Electro-optical Characteristics (Continued)

Item	Unit	CCT	Rank	Min	Typ	Max		
Luminous Flux ⁴⁾ (@50 mA, Ts = 25°C)	lm	2700K	S0	S1	14.02	-	16.61	
				S2	16.61	-	19.21	
				S3	19.21	-	21.80	
		3000K	S0	S1	14.89	-	17.49	
				S2	17.49	-	20.10	
				S3	20.10	-	22.70	
		3500K	S0	S1	15.27	-	17.97	
				S2	17.97	-	20.67	
				S3	20.67	-	23.36	
		4000K	S0	S1	15.57	-	18.39	
				S2	18.39	-	21.20	
				S3	21.20	-	24.02	
		5000K	S0	S1	15.87	-	18.69	
				S2	18.69	-	21.50	
				S3	21.50	-	24.32	
		5700K	S0	S1	15.57	-	18.37	
				S2	18.37	-	21.17	
				S3	21.17	-	23.97	
		6500K	S0	S1	15.27	-	18.06	
				S2	18.06	-	20.84	
				S3	20.84	-	23.63	
		Reverse voltage (@5 mA, Ts = 25°C)	V	-	-	0.7	-	1.2
		Color Rendering Index ³⁾	Ra	-	5	80	-	-

Notes:

1)~3) SAMSUNG ELECTRONICS maintains a tolerance of $V_F: \pm 0.1$ V, $I_V: \pm 5$ %, $R_a: \pm 3.0$ on measurements

4) Luminous Flux(Φ_v , lm) values are representative reference only

4. Typical Characteristics Graph ($T_s = 25^\circ\text{C}$)

1) Spectrum Distribution

[CCT : 2700K]

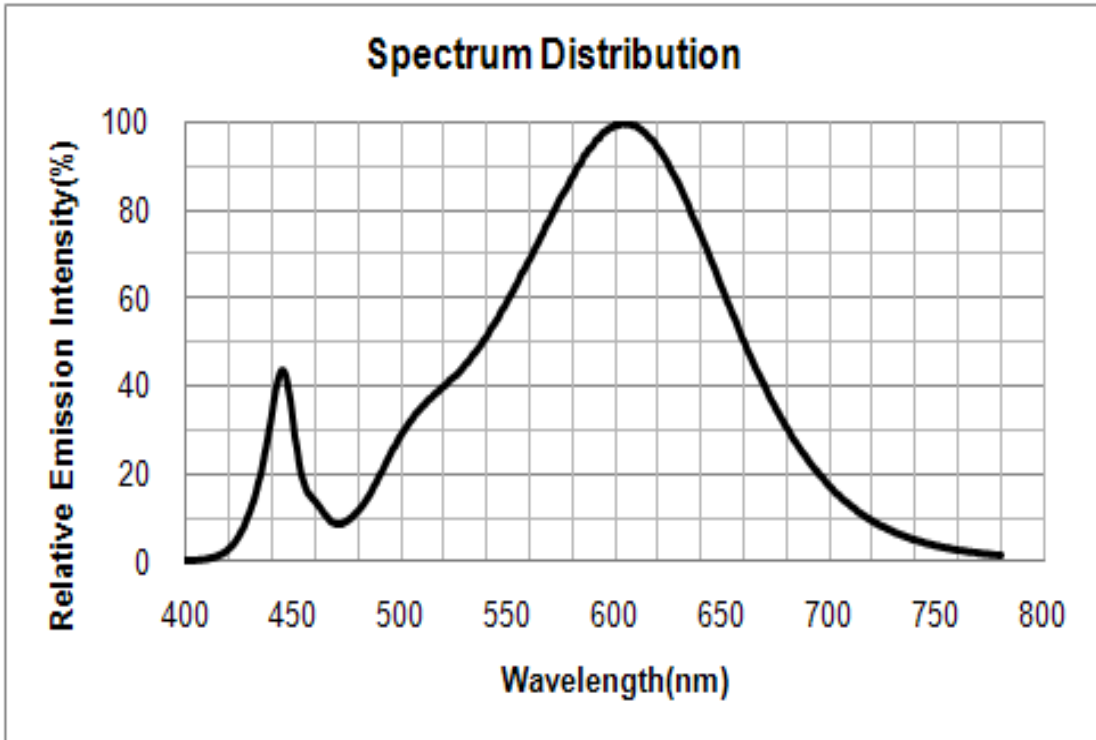

[CCT : 3000K]

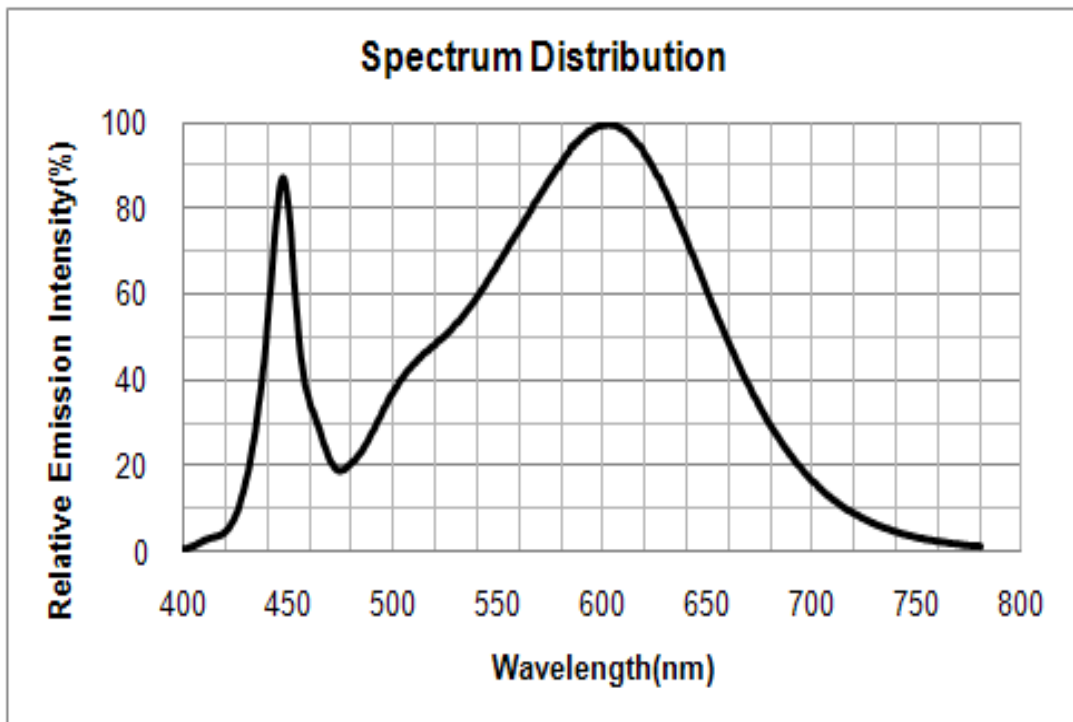

[CCT : 3500K]

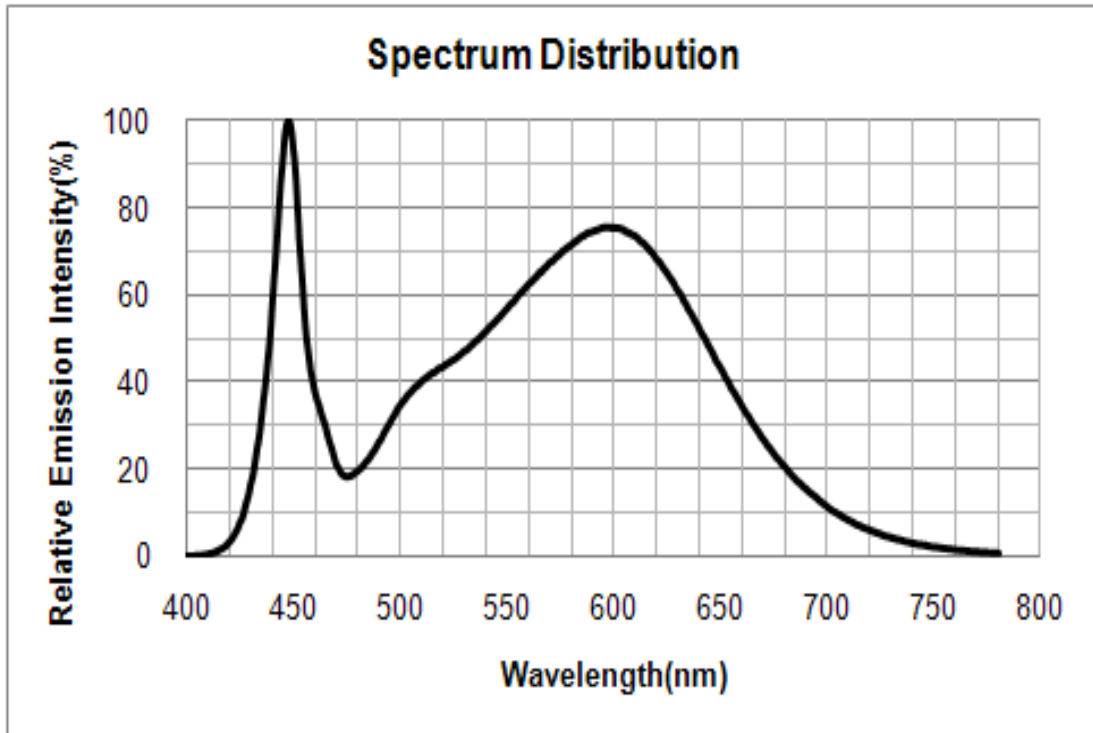

[CCT : 4000K]

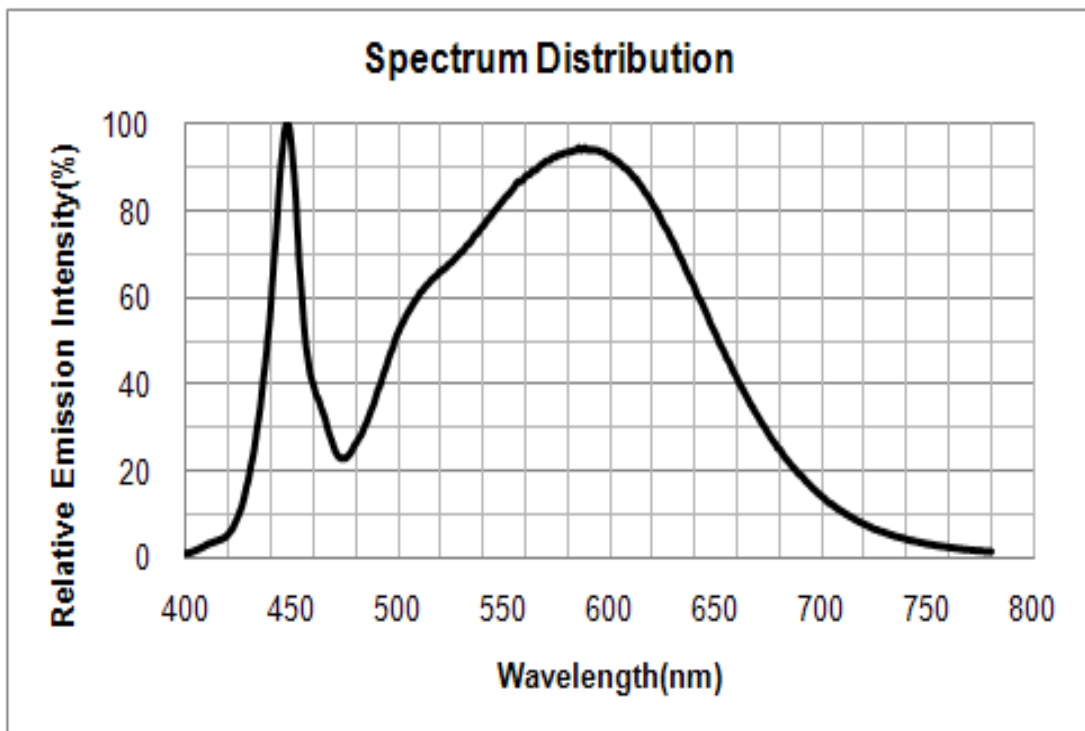

[CCT : 5000K]

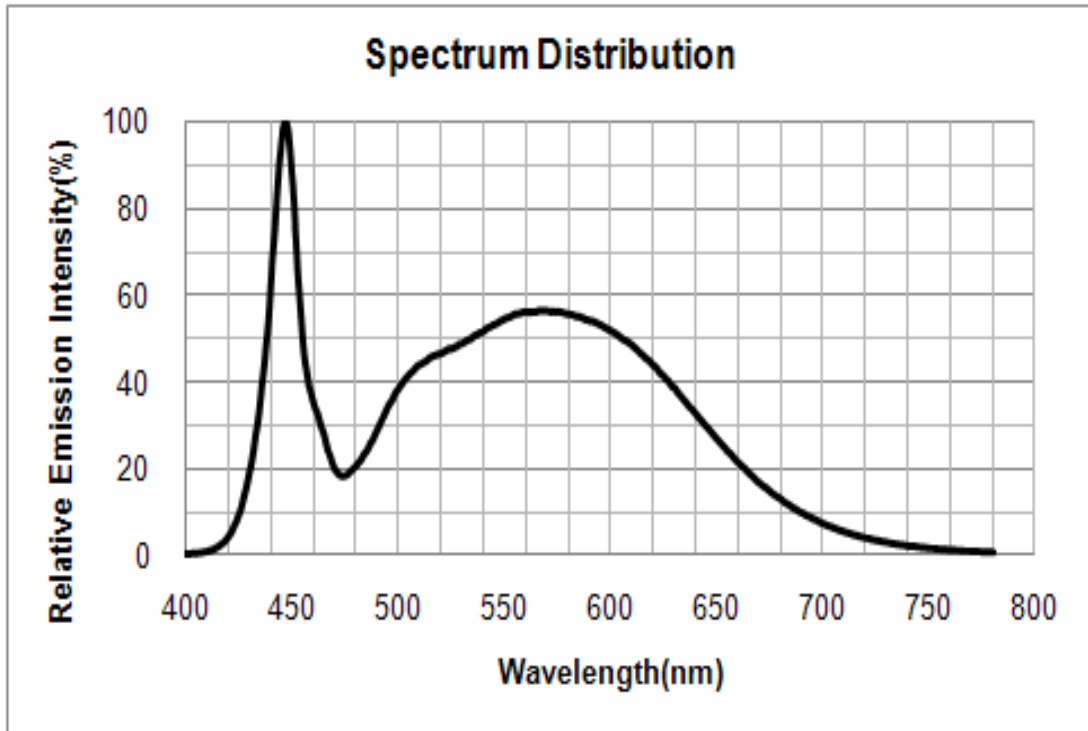

[CCT : 5700K]

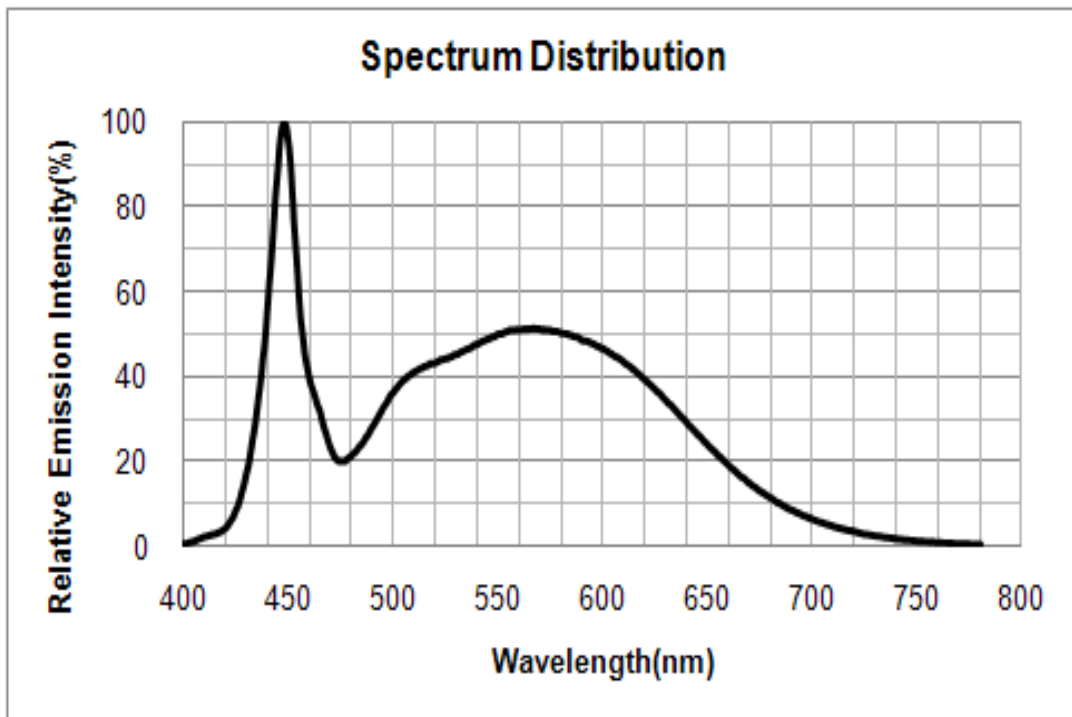

[CCT : 6500K]

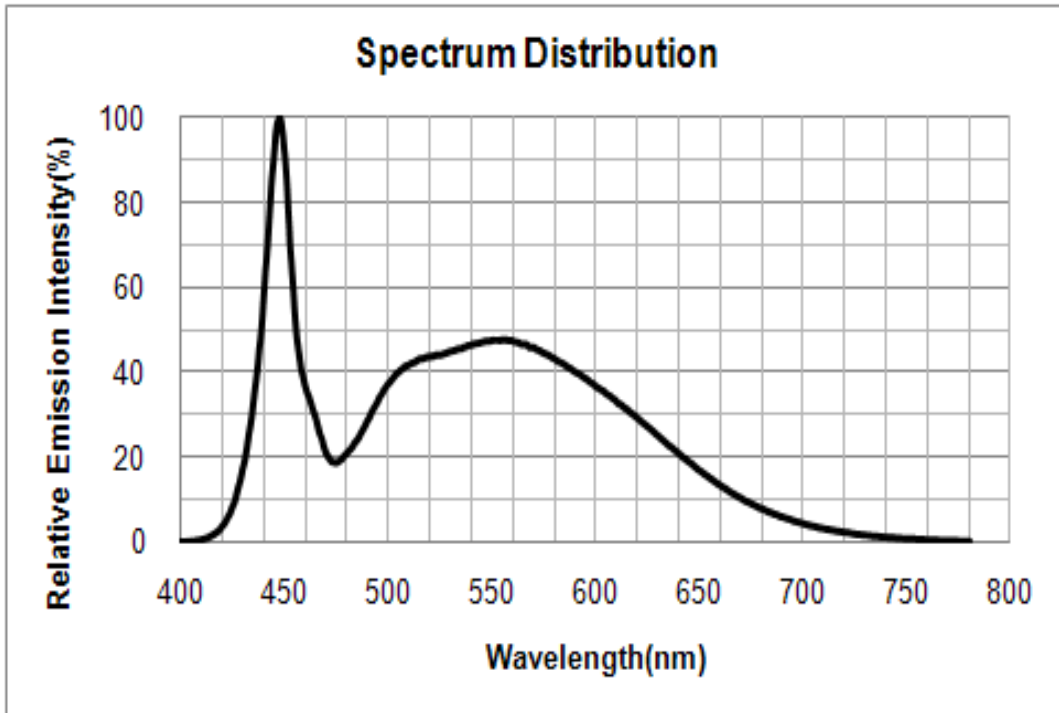

2) Forward Current Characteristics ($T_s = 25^\circ\text{C}$)

[Relative Luminous Flux vs. Forward Current]

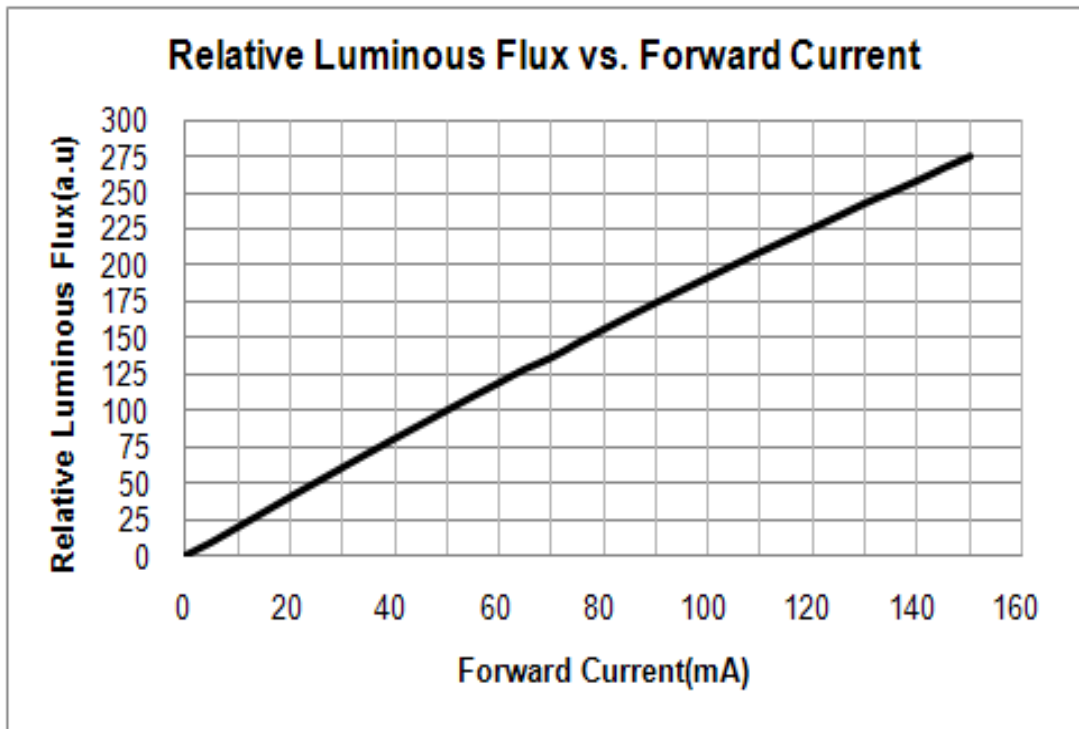

[Forward Current vs. Forward Voltage]

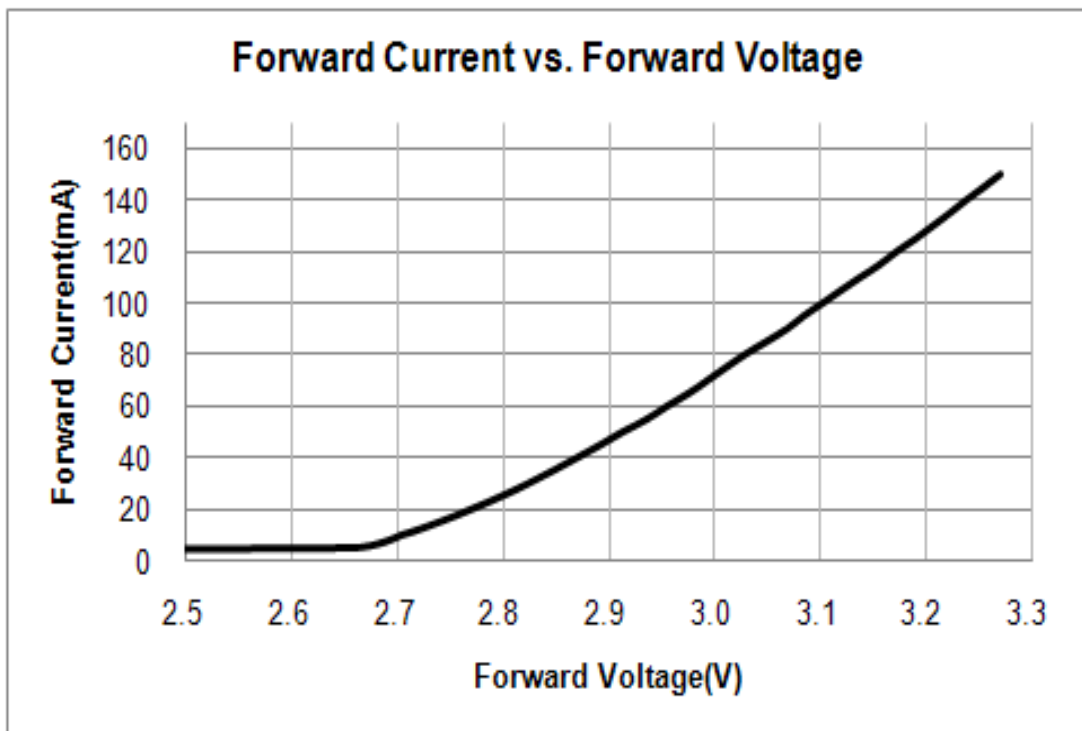

3) Temperature Characteristics

[Relative Luminous Flux vs. Ts]

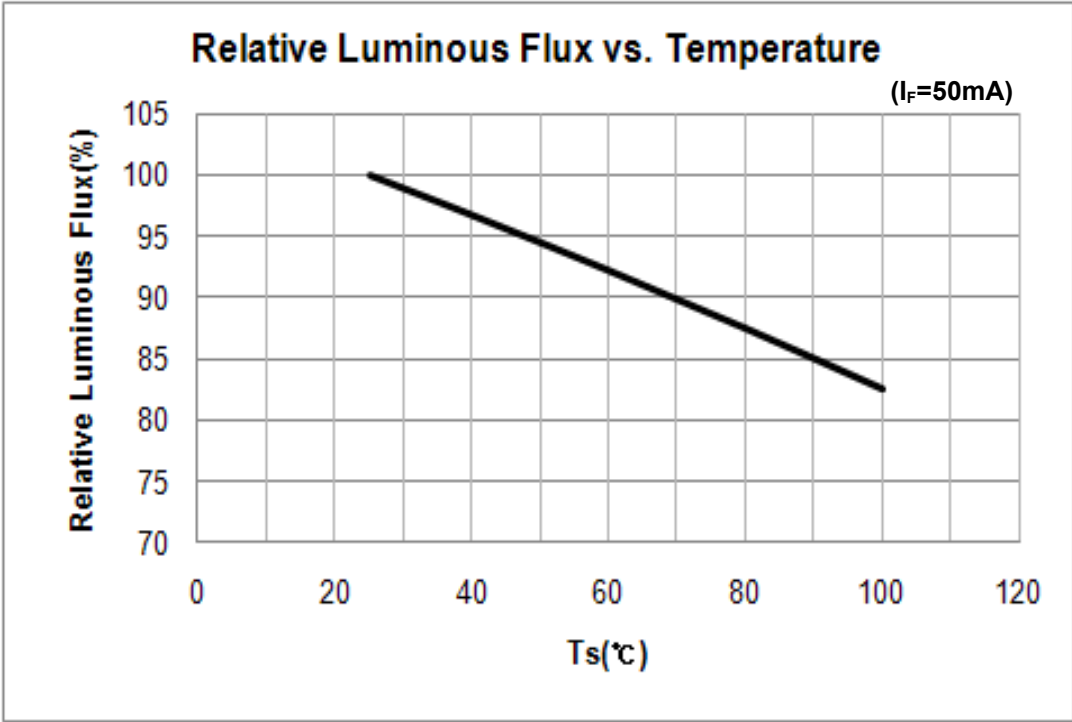

[Forward Voltage vs. Ts]

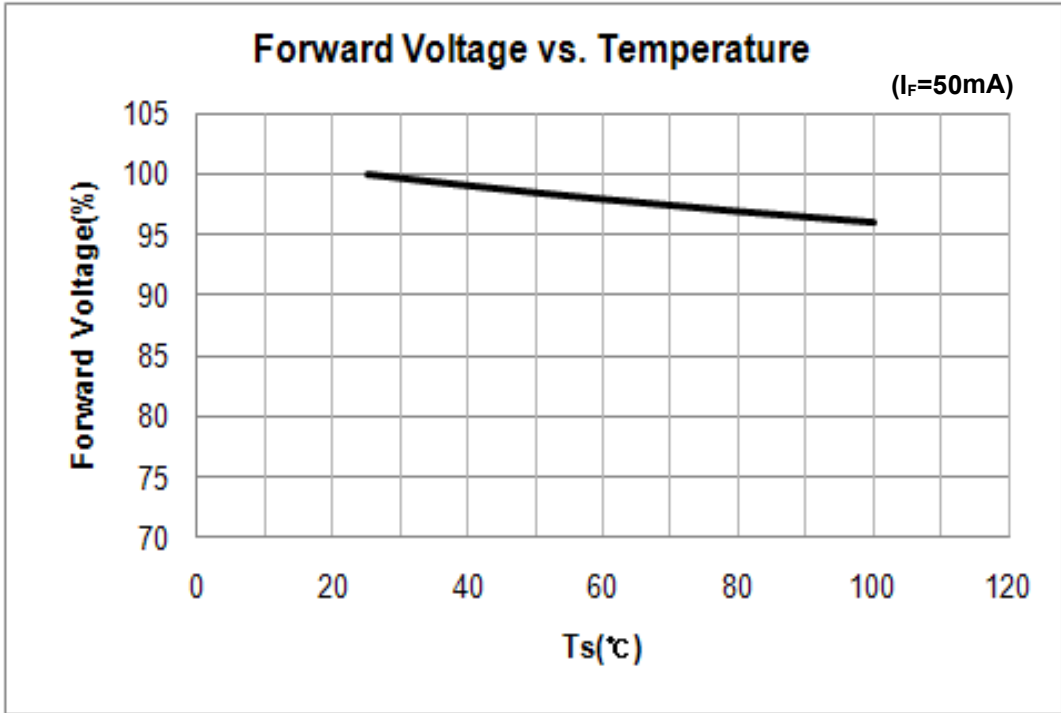

4) Color shift Characteristics

[Forward Current vs. Color Δx , Δy]

($T_s = 25^\circ\text{C}$)

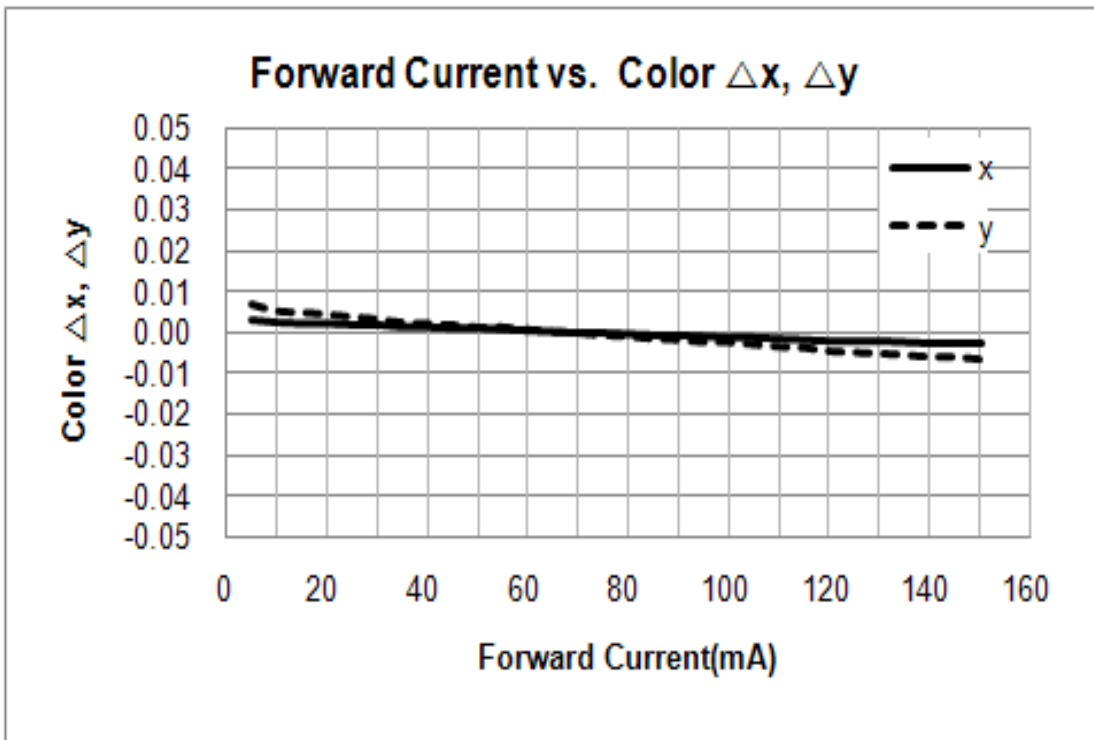

5) Derating Curve

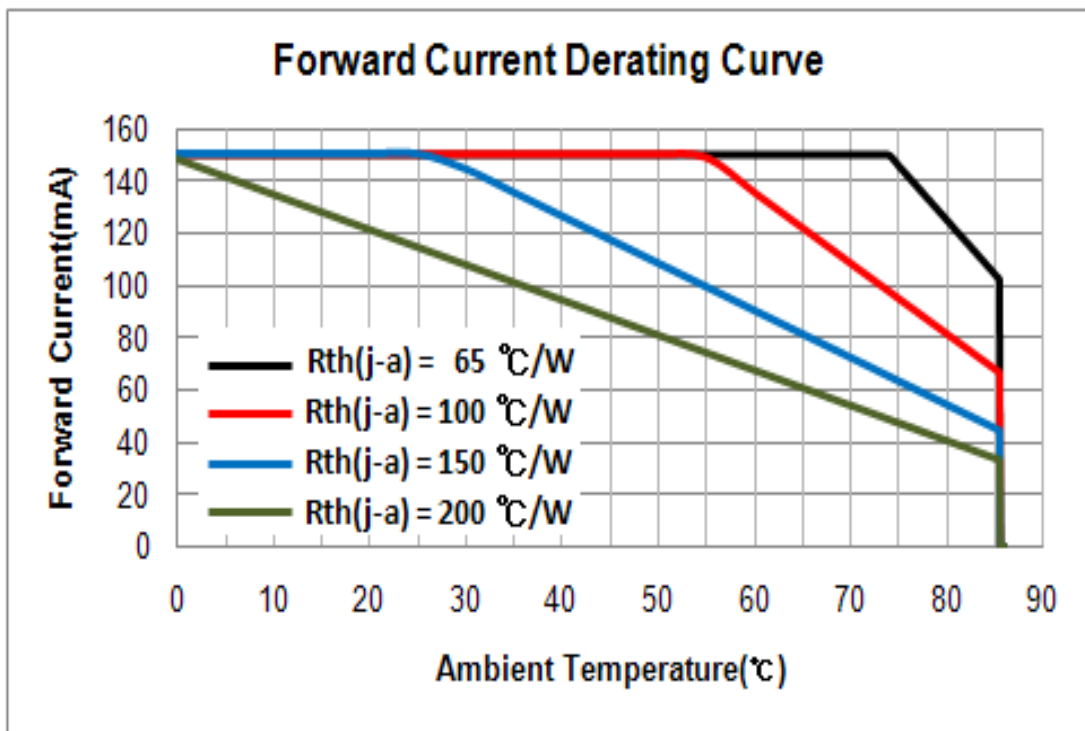

6) Beam Angle Characteristics

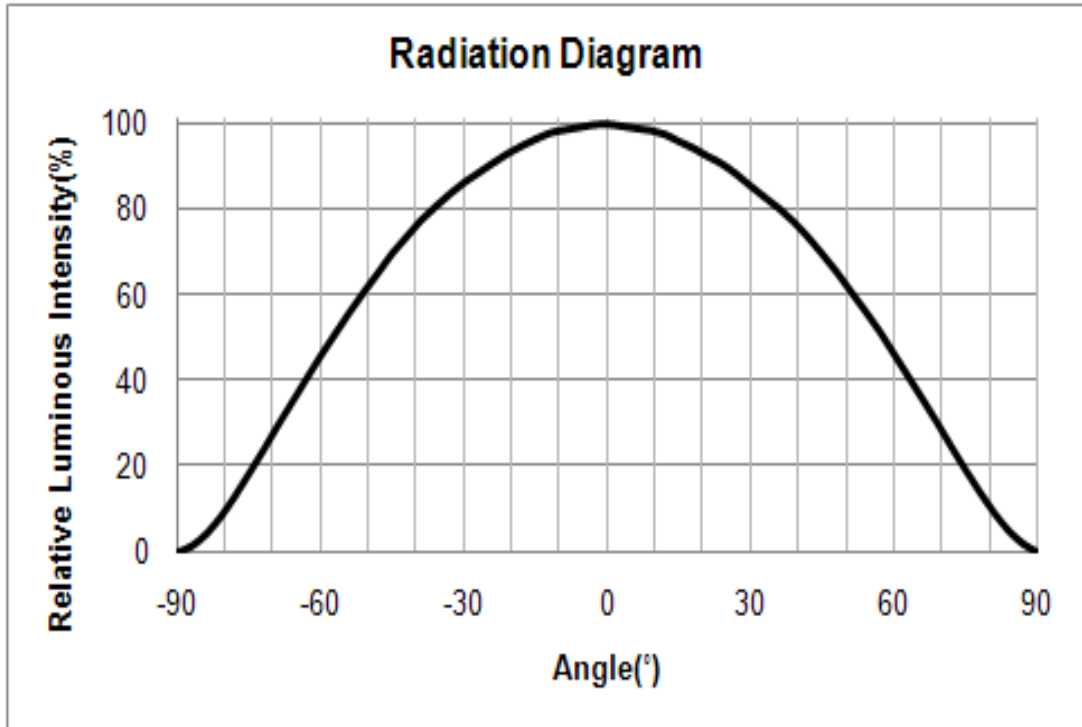

5. Outline Drawing & Dimension

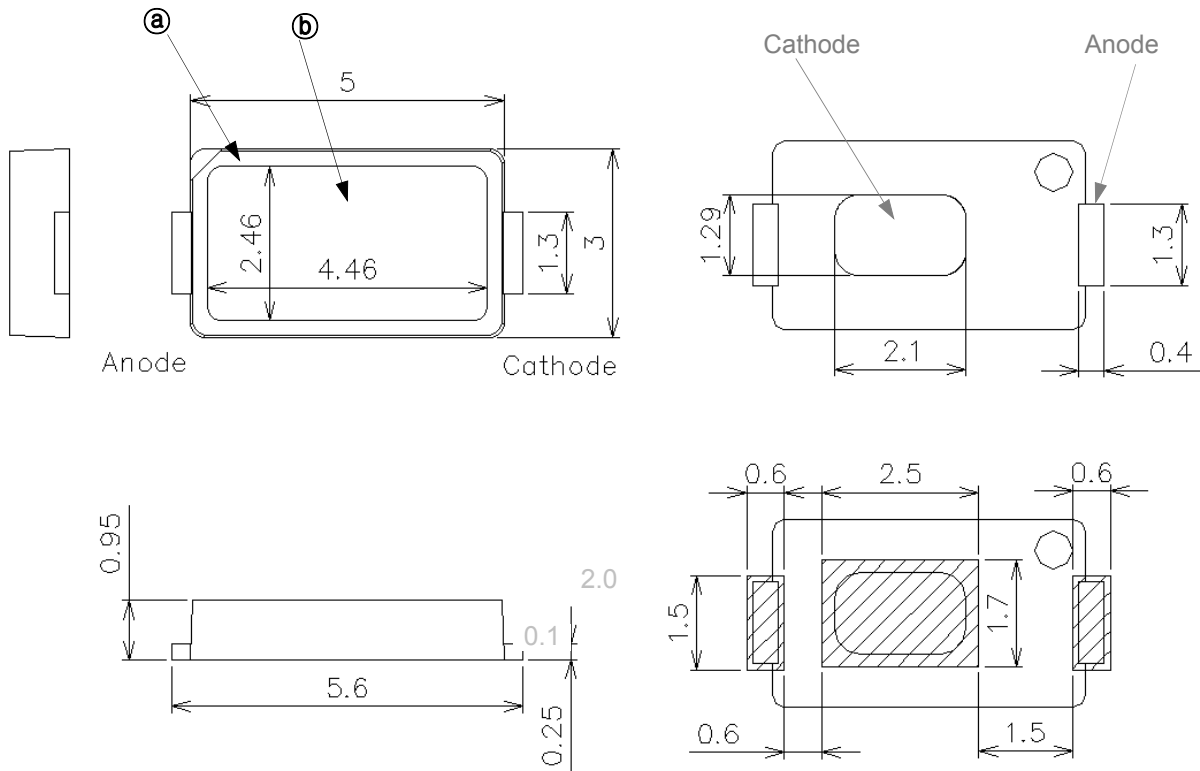

Recommended Land Pattern

1. Tolerance is ± 0.1 mm
2. The maximum compressing force is 15N on the body ①
3. Do not place pressure on the encapsulation resin ②

Notes:

- 1) This LED has built-in ESD protection device(s) connected in parallel to LED Chip(s).
- 2) Ts point & measurement method
 - ① Measure the nearest point to the thermal pad. If necessary, remove PSR of PCB to reach Ts point.
 - ② Thermal pad must be soldered to the PCB to dissipate heat properly. Otherwise, LED can be damaged.
- 3) Precautions
 - ① The pressure on the LEDs will influence to the reliability of the LEDs. Precautions should be taken to avoid the strong pressure on the LEDs. Do not put stress on the LEDs during heating.
 - ② Re-soldering should not be done after the LEDs have been soldered. If re-soldering is unavoidable, LED's characteristics should be carefully checked before and after such repair.
 - ③ Do not stack assembled PCBs together. Since materials of LEDs is soft, abrasion between two PCB assembled with LED might cause catastrophic failure of the LEDs.

6. Reliability Test Items and Conditions

1) Test Items and Results

Test Item	Test Conditions	Test Hours/Cycles	Sample No	
MSL Test	125°C 24hrs drying → 60°C, 60%RH 120hrs → 260°C 10sec 3 cycles	1 cycle	50	
Room Temperature Life Test	25°C±3°C, DC150 mA	1,000 hrs	50	
High Temperature Life Test	85°C±3°C, DC110 mA	1,000 hrs	50	
High Temperature Humidity Life Test	60°C±3°C, 95%±2%RH, DC150 mA	1,000 hrs	50	
High Temperature humidity On/Off Test	85°C±3°C, 85%±2%RH, DC150 mA, On/2sec, Off/5sec	100,000 cycles	50	
Low Temperature Life Test	-40°C±3°C, DC100 mA	1,000 hrs	50	
Temperature humidity Cycle	-10°C ~ 25°C, 95%RH ~ 65°C, 95%RH DC100 mA, 24hrs/1 cycle	10 cycles	50	
Thermal Shock	-45°C/15min ↔ 125°C/15min, 150 cycle → Reflow 260°C → Hot plate 180°C	1 cycle	100	
High Temperature Storage	Ta=100°C±3°C	1000 hrs	11	
Low Temperature Storage	Ta=-40°C±3°C	1000 hrs	11	
Temperature humidity Cycle	-10°C ~ 25°C, 95%RH ~ 65°C, 95%RH 24hrs/1 cycle	10 cycles	11	
ESD(HBM)		R1 : 10MΩ, R2 : 1.5KΩ, C : 100pF, V = ±5kV	5 times	5
ESD(MM)		R1 : 10MΩ, R2 : 0Ω, C : 200pF, V = ±0.2kV	5 times	5
Vibration Test	100~2000~100Hz, 200m/s ² , Sweep 4min, 48min, X, Y, Z 3 direction, each 1 cycle	4 cycles	11	
Mechanical Shock Test	1500G, 0.5ms, 3 shocks each X-Y-Z axis	5 cycles	11	

2) Criteria for Judging the Damage

Item	Symbol	Test Condition	Limit	
			Min	Max
Forward Voltage	V _F	I _F = 50 mA	Init. Value*0.9	Init. Value*1.1
Luminous Intensity	I _v	I _F = 50 mA	Init. Value*0.8	Init. Value*1.2

7. Solder Conditions

1) Reflow Conditions (Pb Free)

Reflow Frequency : 2 times max.

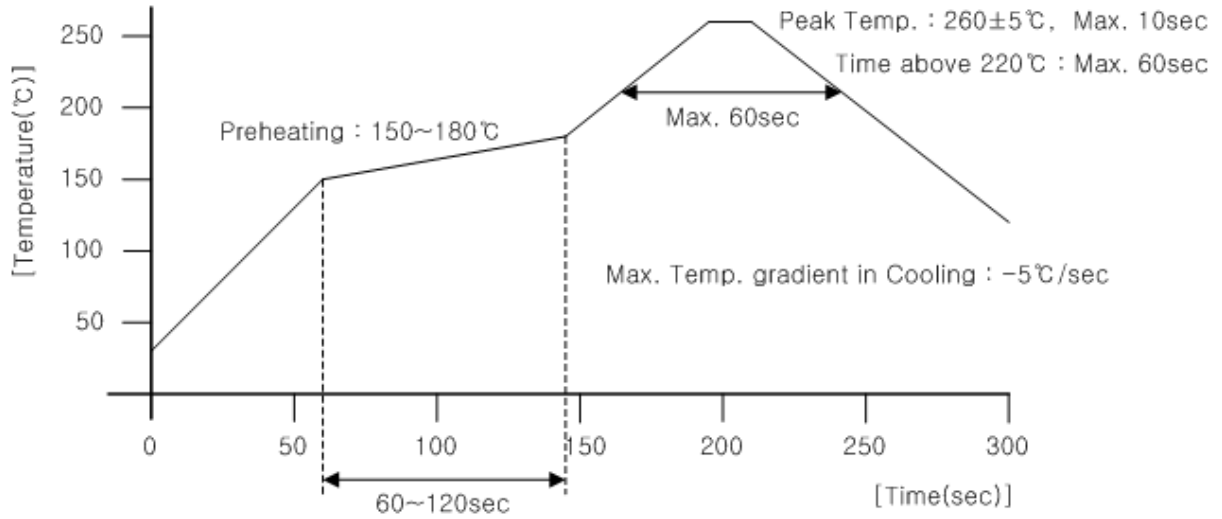

2) For Manual Soldering

Not more than 5 seconds @Max. 300°C, under soldering iron.

8. Tape & Reel

1) Taping Dimension

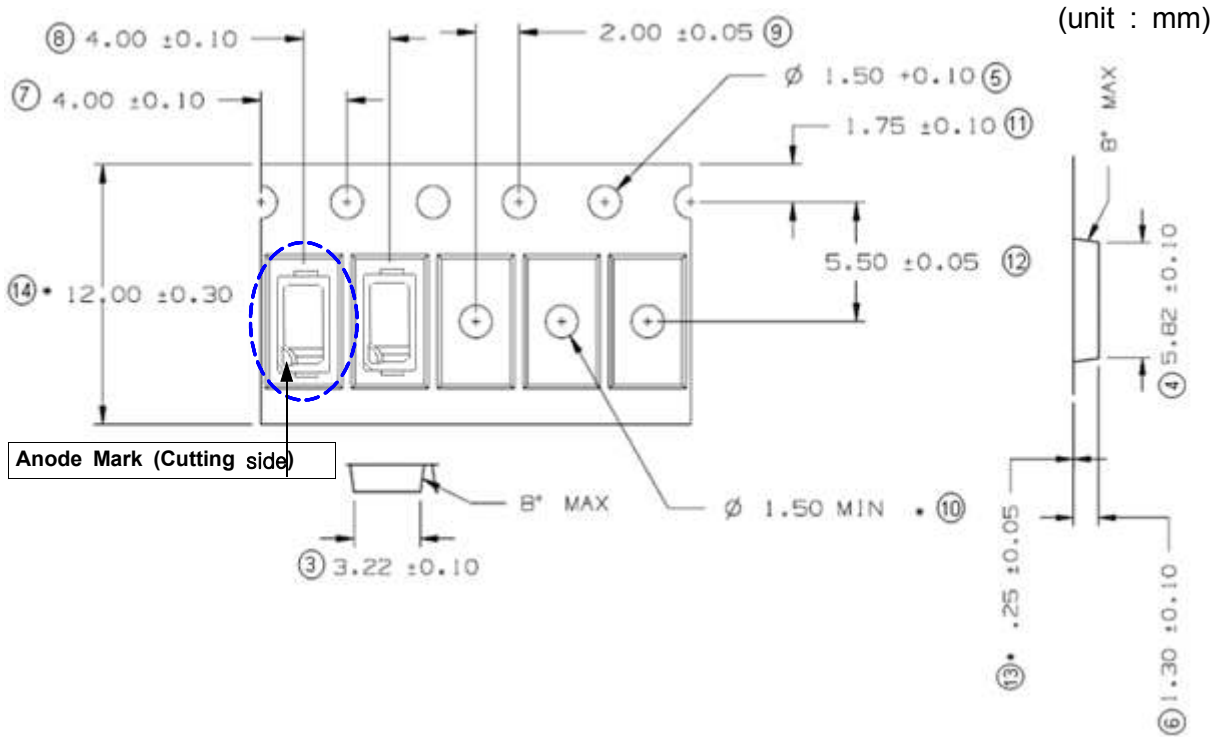

Tapping DIRECTION



End

Start

More than 500mm
Unloaded tape

Mounted with
LED package

More than 100~200mm
Unloaded tape

Leading part more than
500mm

2) Reel Dimension (max 2,500 pcs)

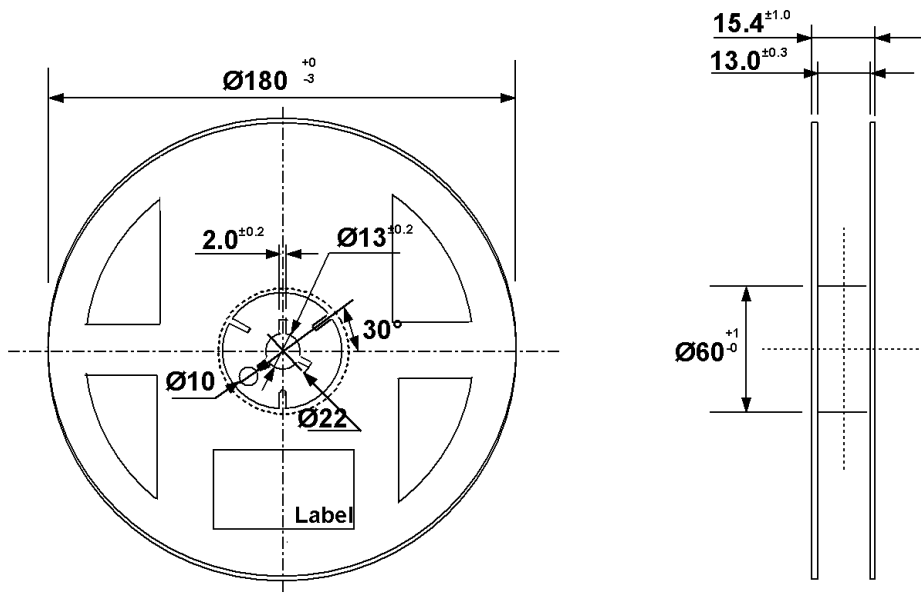

Tolerance ± 0.2 , Unit:mm

- (1) Quantity : The quantity/Reel to be 2,500 pcs.
- (2) Cumulative Tolerance : Cumulative tolerance/10 pitches to be ± 0.2 mm
- (3) Adhesion Strength of Cover Tape : Adhesion strength to be 0.1-0.7N when the cover tape is turned off from the carrier tape at 10°C angle to be the carrier tape.
- (4) Packaging : P/N, Manufacturing data code no. and quantity to be indicated on a damp proof Package.



9. Label Structure

1) Label Structure

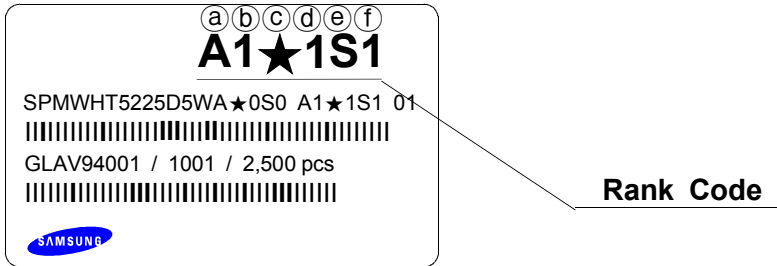

N.B) Denoted rank is the only example.

'★' means All kind of Chromaticity Coordinate Rank.

Rank Code

- ⒶⒷ : Forward Voltage(V_F) Rank (refer to page. 3)
- ⒸⒹ : Chromaticity Coordinate Rank (refer to page. 4)
- ⒺⒻ : Luminous Intensity(cd) Rank (refer to page. 3)

2) LOT Number

The Lot number is composed of the following characters



①②③④⑤⑥⑦⑧⑨ / 1ⒶⒷⒸ / 2,500 PCS

- ① : Production Site (S:SAMSUNG ELECTRONICS, G:TIAJIN CHINA)
- ② : L (LED)
- ③ : Product State (A:Normality, B:Bulk, C:First Production, R:Reproduction, S:Sample)
- ④ : Year (V:2011, W:2012, X:2013...)
- ⑤ : Month (1 ~ 9, A, B)
- ⑥ : Day (1 ~ 9, A, B ~ V)
- ⑦⑧⑨ : SAMSUNG ELECTRONICS LED Product number (1 ~ 999)
- ⒶⒷⒸ : Reel Number (1 ~ 999)



10. Packing Structure

1) Packing Process

Reel

A1★1S1
 SPMWHT5225D5WA★0S0 A1★1S1 01
 GLAV94001 / 1001 / 2,500 pcs

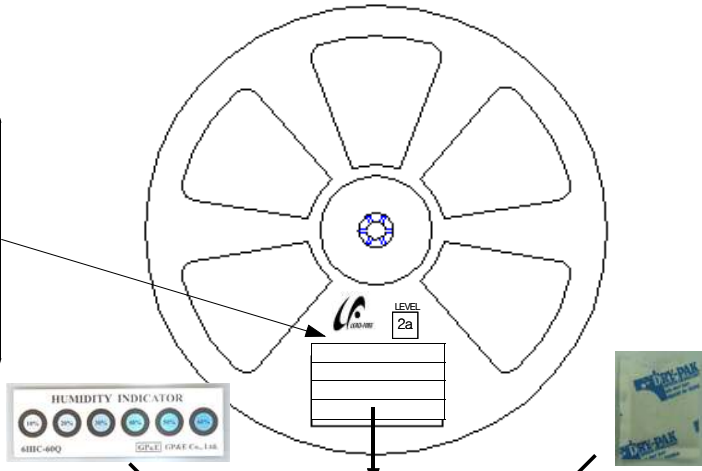

Aluminum Vinyl Bag

A1★1S1
 SPMWHT5225D5WA★0S0 A1★1S1 01
 GLAV94001 / 1001 / 2,500 pcs



Material : Paper(SW3B(B))

TYPE	SIZE(mm)		
	L	W	H
7inch	245±5	220±5	182±5

① SIDE

A1★1S1
 SPMWHT5225D5WA★0S0 A1★1S1 01
 GLAV94001 / 1001 / 25,000 pcs

[Box Label]

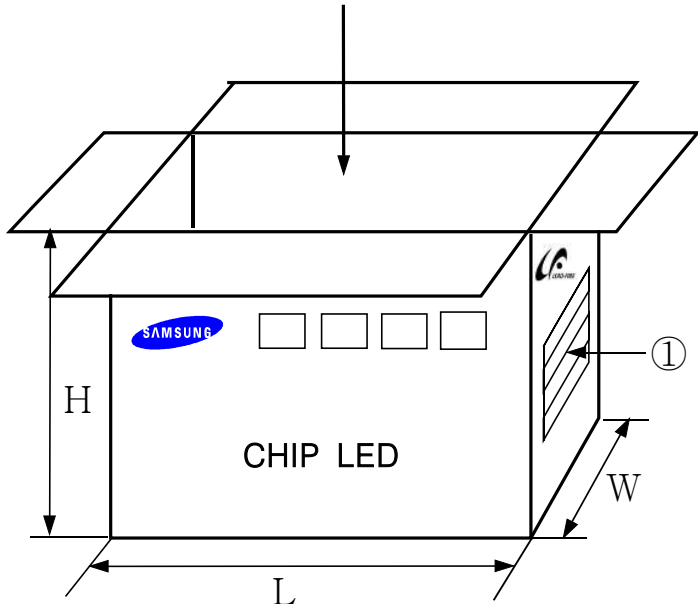

2) Aluminum Packing Bag

CAUTION

This bag contains
MOISTURE SENSITIVE DEVICES

LEVEL
2a

1. Shelf life in sealed bag: 12 months at <math><40^{\circ}\text{C}</math> and <math><90\%</math> relative humidity (RH)
2. Peak package body temperature: 240 °C
3. After this bag is opened, devices that will be subjected to reflow solder or other high temperature processes must be:
 - a. Mounted within 672 hours at factory conditions of equal to or less than 30°C / 60% RH, or
 - b. Stored at <math><10\%</math> RH
4. Devices require bake, before mounting, if:
 - a. Humidity Indicator Card is > 65% when read at 23±5°C, or
 - b. 2a is not met.
5. If baking is required, devices must be baked for 1 hours at 60±5°C

Note: if device containers cannot be subjected to high temperature or shorter bake times are desired, reference IPC/JEDEC J-STD-033 for bake procedure,

Bag seal due date: _____
(if blank, see code label)

Note: Level and body temperature by IPC/JEDEC J-STD-020

A1★1S1

SPMWHT5225D5WA★0S0 A1★1S1 01

GLAV94001 / 1001 / 2,500 pcs



■ 주의 사항

이 알루미늄 지퍼 백은 습기 및 정전기로부터 제품을 보호하기 위하여 제작되었습니다. 개봉 후에는 즉시 솔더 작업을 실시하는 것을 권장합니다.

습기 및 정전기로부터 제품을 보호 하기 위해서 개봉 후 사용하지 않는 자재는 본 팩에 넣어 보관 하시기 바랍니다. 사용하지 않는 자재를 본 팩에 넣을 때는 반드시 동봉된 드라이 팩과 함께 넣고 지퍼부분을 완전하게 밀봉하여 주시기 바랍니다.

■ Important

This Al Zipper bag is designed to protect the enclosed products from moisture and ESD. Once opened, the products should be soldered onto the printed circuit board immediately. When not in use, please do not leave the products unprotected by the Al Zipper Bag. To repack unused products., please ensure the zip-lock is completely sealed with the dry pack left inside.

Silica gel & Humidity Indicator Card in Aluminum Vinyl Bag

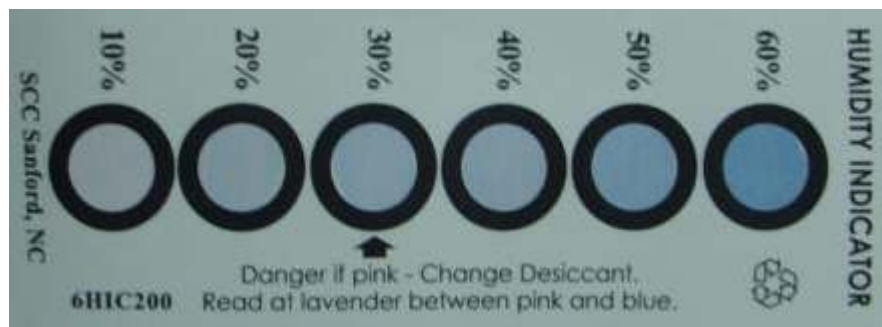

11. Precaution for use

- 1) For over-current-proof function, customers are recommended to apply resistors to prevent sudden change of the current caused by slight shift of the voltage.

과전류 방지를 위해 전압의 미세한 이동에 의해 야기되는 전류의 순간 변화를 방지하기 위해 저항 등의 설치를 권장함.

- 2) This device should not be used in any type of fluid such as water, oil, organic solvent, etc. When washing is required, IPA is recommended to use.

제품은 물, 오일, 유기물과 같은 액체 타입에서의 사용은 제한되며, 세정이 필요할 시에는 IPA 사용을 권장함.

- 3) When the LEDs illuminate, operating current should be decided after considering the ambient maximum temperature.

LED의 발광 시, 동작 전류는 주변 최고온도를 고려하여 결정되어야 함.

- 4) LEDs must be stored in a clean environment.

If the LEDs are to be stored for 3 months or more after being shipped from Samsung Electronics, they should be packed by a sealed container with nitrogen gas injected.(Shelf life of sealed bags: 12 months, temp. $\sim 40^{\circ}\text{C}$, $\sim 90\%RH$)

LED의 보관은 청정한 환경에서 보존되어야 하며, 만약 삼성전자로부터 공급받는 후 3개월 또는 그 이상 보관이 필요하다면 질소 가스를 동봉한 보존용기에 보관되어야 함. (보존 bag의 수명 : 12 개월, 보존 온도 $\sim 40^{\circ}\text{C}$, 습도 $\sim 90\%RH$)

- 5) After storage bag is open, device subjected to soldering, solder reflow, or other high temperature processes must be:

보존 Bag이 개봉된 후에, 납땀이나 reflow등의 높은 온도에 노출되는 제품은 다음의 사항에 부합되어야 함.

a. Mounted within 672 hours(28 days) at an assembly line with a condition of no more than $30^{\circ}\text{C}/60\%RH$,

a. 제품은 $30^{\circ}\text{C}/60\%RH$ 보다 같거나 낮은 조립조건에서 672시간(28일)이내에 조립해야 함.

b. Stored at $<10\%RH$.

b. 10% 이하의 상대습도에서 보관되어야 함.

- 6) Repack unused Products with anti-moisture packing, fold to close any opening and then store in a dry place.

사용하지 않은 제품은 방습팩에 넣어 개봉 부위를 닫아서 다시 포장한 후, 건조한 장소에서 보관할 것을 권장함.

7) Devices require baking before mounting, if humidity card reading is $>60\%$ at $23\pm 5^{\circ}\text{C}$.

만약 습도표시카드의 수치가 $23\pm 5^{\circ}\text{C}$ 에서 60% 이상이라면, 제품 실장 전에 baking해야 함.

8) Devices must be baked for 1 hour at $65\pm 5^{\circ}\text{C}$, if baking is required.

만약 baking이 필요하다면, 제품은 $65\pm 5^{\circ}\text{C}$ 에서 1시간 정도 baking 되어야 함.

9) The LEDs are sensitive to the static electricity and surge. It is recommended to use a wrist band or anti-electrostatic glove when handling the LEDs.

LED는 정전기 및 서지에 민감한 제품이므로, LED 제품을 다룰 시에는 정전기 방지장갑이나 손목밴드를 사용하기를 권장함.

If voltage exceeding the absolute maximum rating is applied to LEDs, it may cause damage or even destruction to LED devices.

만약 절대 허용치를 초과하는 전압이 LED에 가해지면, LED 소자는 파괴되거나 손상될 수 있음.

Damaged LEDs may show some unusual characteristics such as increase in leak current, lowered turn-on voltage, or abnormal lighting of LEDs at low current.

손상된 제품은 누설전류의 증가, Turn on 전압의 저하, 저 전류에서의 점등불량 등의 이상 거동을 보일 수 있음.

10) VOCs (volatile organic compounds) can be generated from adhesives, flux, hardener or organic additives used in luminaires(fixtures).

Transparent LED silicone encapsulant is permeable to those chemicals and they may lead a discoloration of encapsulant when they expose to heat or light.

VOCs(휘발성 유기 화합물)는 등기구에 사용되는 접착제, Flux, 경화제, 유기물 첨가제에서 발생하여 LED 실리콘 봉지제를 투과하고, 빛 또는 열에 노출되었을 때 변색이 발생 할 수 있음.

This phenomenon can cause a significant loss of light emitted(output) from the luminaires(fixtures).

이러한 현상은 등기구로부터 나오는 빛의 중대한 손실을 줄 수 있음.

In order to prevent these problems, we recommend you to know the physical properties of the materials used in luminaires, They must be selected carefully.

이러한 문제 발생 방지를 위해서, 등기구에 사용되는 자재에 대한 물성을 알고 주의하여 선택 되어야함.

11) Risk of Sulfurization (or Tarnishing)

The LED from Samsung Electronics uses a silver-plated lead frame and its surface color may change to black(or dark colored) when it is exposed to sulfur(S), chlorine (Cl) or other halogen compound.

삼성전자의 LED는 Ag(은)을 도금한 리드프레임을 사용함. 이 리드프레임의 표면이 황(S), 염소(Cl), 또는 다른 할로겐 화합물들에 노출시 Ag(은)은 검정(또는 어두운색)으로 바뀔 수 있음.

Sulfurization of lead frame may cause intensity degradation, change of chromaticity coordinates and, in extreme cases, open circuit. It requires caution.

리드 프레임의 황화(Sulfurization)는 광량 저하, 색좌표 변화 및 심한 경우 LED 무등(Open) 불량을 일으킬 수도 있으니 주의가 필요함.

Due to possible sulfurization of lead frame, LED should not be used and stored together with oxidizing substances made of materials in a following list,

: Rubber, plain paper, lead solder cream and so on.

리드 프레임 황화(Sulfurization)의 근원이 될 수 있으니 LED는 아래의 목록으로 만들어진 산화성 물질들과 함께 저장, 사용이 불가함 : 고무, 일반 종이, 납땀 크림 등



12. Hazard Substance Analysis - SGS



Test Report No. F690101/LF-CTSAYAA12-16422

Issued Date: 2012. 04. 30 Page 1 of 6

To: **SAMSUNG ELECTRONICS CO., LTD.**
Nongseo-dong
Giheung-gu
Yongin-si
Gyeonggi-do
Korea

The following merchandise was submitted and identified by the client as :

SGS File No.	: AYAA12-16422
Product Name	: LED Package
Item No./Part No.	: 5630 WHITE PKG
Received Date	: 2012. 04. 23
Test Period	: 2012. 04. 24 to 2012. 04. 30
Test Results	: For further details, please refer to following page(s)
Test Performed	: SGS Korea tested the sample(s) selected by applicant with following results.
Test Comments	: By the applicant's specific request, the sampling and testing was performed only for the part indicated in the photo without disassembly.

SGS Korea Co. Ltd.

Jeff Jang / Chemical Lab Mgr

Timothy Jeon
Jinhee Kim
Cindy Park
Jerry Jung/ Testing Person

This document is issued by the Company subject to its General Conditions of Service printed hereon, available on request or accessible at www.sgs.com and its electronic format document subject to Terms and Conditions for Electronic Documents at www.sgs.com. Attention is drawn to the limitation of liability, indemnification and jurisdiction clause (where applicable) included in the General Conditions of Service. The document is intended for the information of the Client and is not to be used for any other purpose. The document is not to be used for any other purpose without the prior written approval of the Company. The document is not to be used for any other purpose without the prior written approval of the Company. The document is not to be used for any other purpose without the prior written approval of the Company.

F052 Version4

SGS Korea Co., Ltd

322, The Ovalley, 555-9, Hoge-dong, Dongan-gu, Anyang-si, Gyeonggi-do, Korea 431-060
T +82 (0)31 4008 000 F +82 (0)31 4008 059 <http://www.sgs.com> www.kr.sgs.com

Member of the SGS Group (Société Générale de Surveillance)

Test Report No. F690101/LF-CTSAYAA12-16422

Issued Date: 2012. 04. 30 Page 2 of 6

Sample No. : AYAA12-16422.001
Sample Description : LED Package
Item No./Part No. : 5630 WHITE PKG
Materials : N/A

Heavy Metals

Test Items	Unit	Test Method	MDL	Results
Cadmium (Cd)	mg/kg	With reference to IEC 62321:2008, ICP	0.5	N.D.
Lead (Pb)	mg/kg	With reference to IEC 62321:2008, ICP	5	N.D.
Mercury (Hg)	mg/kg	With reference to IEC 62321:2008, ICP	2	N.D.
Hexavalent Chromium (Cr VI)	mg/kg	With reference to IEC 62321:2008, UV-VIS	1	N.D.
Arsenic (As)	mg/kg	With reference to EPA 3052(1996), US EPA 6010B(1996), ICP	10	N.D.
Antimony (Sb)	mg/kg	With reference to EPA 3052(1996), US EPA 6010B(1996), ICP	10	N.D.
Beryllium (Be)	mg/kg	With reference to EPA 3052(1996), US EPA 6010B(1996), ICP	0.5	N.D.

Flame Retardants-PBBs/PBDEs

Test Items	Unit	Test Method	MDL	Results
Monobromobiphenyl	mg/kg	With reference to IEC 62321:2008, GC-MS	5	N.D.
Dibromobiphenyl	mg/kg	With reference to IEC 62321:2008, GC-MS	5	N.D.
Tribromobiphenyl	mg/kg	With reference to IEC 62321:2008, GC-MS	5	N.D.
Tetrabromobiphenyl	mg/kg	With reference to IEC 62321:2008, GC-MS	5	N.D.
Pentabromobiphenyl	mg/kg	With reference to IEC 62321:2008, GC-MS	5	N.D.
Hexabromobiphenyl	mg/kg	With reference to IEC 62321:2008, GC-MS	5	N.D.
Heptabromobiphenyl	mg/kg	With reference to IEC 62321:2008, GC-MS	5	N.D.
Octabromobiphenyl	mg/kg	With reference to IEC 62321:2008, GC-MS	5	N.D.
Nonabromobiphenyl	mg/kg	With reference to IEC 62321:2008, GC-MS	5	N.D.
Decabromobiphenyl	mg/kg	With reference to IEC 62321:2008, GC-MS	5	N.D.
Monobromodiphenyl ether	mg/kg	With reference to IEC 62321:2008, GC-MS	5	N.D.
Dibromodiphenyl ether	mg/kg	With reference to IEC 62321:2008, GC-MS	5	N.D.
Tribromodiphenyl ether	mg/kg	With reference to IEC 62321:2008, GC-MS	5	N.D.
Tetrabromodiphenyl ether	mg/kg	With reference to IEC 62321:2008, GC-MS	5	N.D.
Pentabromodiphenyl ether	mg/kg	With reference to IEC 62321:2008, GC-MS	5	N.D.

- NOTE: (1) N.D. = Not detected, (<MDL)
 (2) mg/kg = ppm
 (3) MDL = Method Detection Limit
 (4) - = No regulation
 (5) Negative = Undetectable / Positive = Detectable
 (6) ** = Qualitative analysis (No Unit)
 (7) * = Boiling-water-extraction:
 Negative = Absence of CrVI coating
 Positive = Presence of CrVI coating; the detected concentration in boiling-water-extraction solution is equal or greater than 0.02 mg/kg with 50 cm² sample surface area.

This document is issued by the Company subject to its General Conditions of Service printed matter, available on request or accessible at www.sgs.com/termsandconditions and for electronic format documents subject to Terms and Conditions for Electronic Documents at www.sgs.com/termsandconditions. Attention is drawn to the limitation of liability, indemnification and jurisdiction clause defined therein. Any holder of this document is advised that the information contained herein reflects the Company's findings at the time of its intervention only and within the limits of Client's instructions. Also, the Company's sole responsibility is to Client and this document does not constitute a contract or a replacement for existing other legal rights and obligations under the transaction documents. This document can only be reproduced or distributed prior written approval of the Company's operational division. Rights to utilization of the content or appearance of this document, its content and information may be prosecuted in the field cases of the law. Client's attention is drawn to the fact that the report refers only to the samples tested and such samples are retained for 180 days only.

Test Report No. F690101/LF-CTSAYAA12-16422

Issued Date: 2012. 04. 30 Page 3 of 6

Sample No. : AYAA12-16422.001
Sample Description : LED Package
Item No./Part No. : 5630 WHITE PKG
Materials : N/A

Flame Retardants-PBBs/PBDEs

Test Items	Unit	Test Method	MDL	Results
Hexabromodiphenyl ether	mg/kg	With reference to IEC 62321:2008, GC-MS	5	N.D.
Heptabromodiphenyl ether	mg/kg	With reference to IEC 62321:2008, GC-MS	5	N.D.
Octabromodiphenyl ether	mg/kg	With reference to IEC 62321:2008, GC-MS	5	N.D.
Nonabromodiphenyl ether	mg/kg	With reference to IEC 62321:2008, GC-MS	5	N.D.
Decabromodiphenyl ether	mg/kg	With reference to IEC 62321:2008, GC-MS	5	N.D.

Halogen Contents

Test Items	Unit	Test Method	MDL	Results
Bromine(Br)	mg/kg	BS EN 14582:2007, IC	30	N.D.
Chlorine(Cl)	mg/kg	BS EN 14582:2007, IC	30	N.D.
Fluorine(F)	mg/kg	BS EN 14582:2007, IC	30	60
Iodine(I)	mg/kg	BS EN 14582:2007, IC	50	N.D.

Organotin Compounds

Test Items	Unit	Test Method	MDL	Results
Monobutyltin (MBT)	mg/kg	DIN 38407-13, GC/MS	0.1	N.D.
Dibutyltin (DBT)	mg/kg	DIN 38407-13, GC/MS	0.1	N.D.
Tributyltin (TBT)	mg/kg	DIN 38407-13, GC/MS	0.1	N.D.
Bis (tributyltin)oxide (TBTO)	mg/kg	DIN 38407-13, GC/MS	0.1	N.D.
Bis (tributyltin)oxide (TBTO)*	mg/kg	DIN 38407-13, GC/MS	0.1	N.D.
Tetrabutyltin (TeBT)	mg/kg	DIN 38407-13, GC/MS	0.1	N.D.
Triphenyltin (TPhT)	mg/kg	DIN 38407-13, GC/MS	0.1	N.D.
Monooctyltin(MOT)	mg/kg	DIN 38407-13, GC/MS	0.1	N.D.
Dioctyltin(DOT)	mg/kg	DIN 38407-13, GC/MS	0.1	N.D.

Other(s)

Test Items	Unit	Test Method	MDL	Results

NOTE: (1) N.D. = Not detected.(<MDL)

(2) mg/kg = ppm

(3) MDL = Method Detection Limit

(4) - = No regulation

(5) Negative = Undetectable / Positive = Detectable

(6) ** = Qualitative analysis (No Unit)

(7) * = Boiling-water-extraction:

Negative = Absence of CrVI coating

 Positive = Presence of CrVI coating; the detected concentration in boiling-water-extraction solution is equal or greater than 0.02 mg/kg with 50 cm² sample surface area.

This document is issued by the Company subject to its General Conditions of Service printed elsewhere, available on request or accessible at www.sgs.com and for electronic format documents, subject to Terms and Conditions for Electronic Documents at www.sgs.com. Clients are aware of the limitation of liability, indemnification and jurisdiction clauses defined therein. The Company's sole responsibility is to its Client and this document does not constitute any offer or obligation under the transaction documents. This document cannot be reproduced except in full without prior written approval of the Company's operational director. Rights of reproduction of this document or application of its results are reserved and allowed only for the purpose of the intended use of the data. Clients should be aware that the results shown in this report refer only to the samples tested and such samples) are related to 100 days only.

F052 Version4

SGS Korea Co., Ltd

 322, The O Valley, 555-B, Hoge-dong, Dongan-gu, Anyang-si, Gyeonggi-do, Korea 431-000
 T +82 (0)31 4008 050 F +82 (0)31 4008 050 <http://www.sgs.com> www.kr.sgs.com

Member of the SGS Group (Société Générale de Surveillance)



Test Report No. F690101/LF-CTSAYAA12-16422

Issued Date: 2012. 04. 30 Page 4 of 6

Sample No. : AYAA12-16422.001
 Sample Description : LED Package
 Item No./Part No. : 5630 WHITE PKG
 Materials : N/A

Other(s)

Test Items	Unit	Test Method	MDL	Results
PFOS(Perfluorooctane Sulfonates-Acid/Metal Salt/Amide)	mg/kg	US EPA 3540C/3650C, LC/MS	1	N.D.

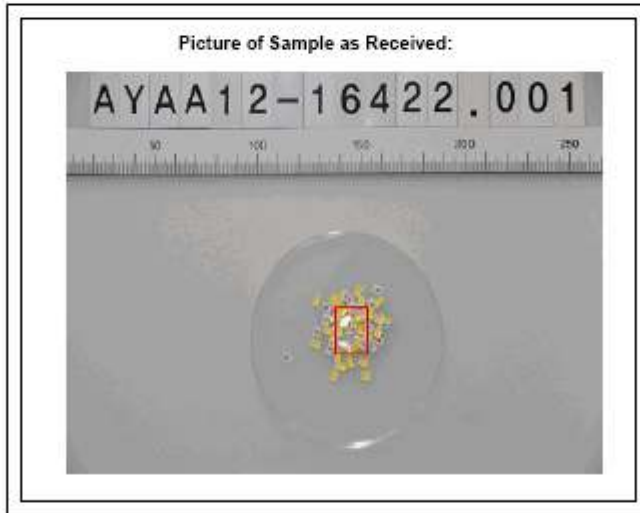

- NOTE: (1) N.D. = Not detected.(<MDL)
 (2) mg/kg = ppm
 (3) MDL = Method Detection Limit
 (4) - = No regulation
 (5) Negative = Undetectable / Positive = Detectable
 (6) ** = Qualitative analysis (No Unit)
 (7) * = Boiling-water-extraction:
 Negative = Absence of CrVI coating
 Positive = Presence of CrVI coating; the detected concentration in boiling-water-extraction solution is equal or greater than 0.02 mg/kg with 50 cm² sample surface area.

This document is issued by the Company subject to its General Conditions of Service which are available on request or accessible at www.sgs.com/termsandconditions and, for electronic format documents, subject to Terms and Conditions for Electronic Documents at www.sgs.com/termsandconditions. Liability is limited to the limitation of liability, indemnification and jurisdiction clauses defined therein. Any notice of this document is deemed to be received by you unless the Company's notice at the time of its submission only and shall be that of Client's acknowledgment. The Company's sole responsibility is to its Client and its client does not in any way release it from its liability and obligations under the transaction documents. This document can be reproduced or stored in any medium without prior written approval of the Company. Unauthorised alteration, copying, reproduction or distribution is prohibited and offenders may be prosecuted to the fullest extent of the law. (Data obtained under test conditions may vary slightly from the sample's actual and/or sample's certification for 100% accuracy)

F052 Version4

SGS Korea Co., Ltd.

333, The D Valley, 555-6, Hagee-dong, Gangbuk-gu, Anyang-si, Gyeonggi-do, Korea 431-000
 T +82 (0)31 4826 000 F +82 (0)31 4806 000 <http://www.sgs.com> www.kr.sgs.com

Member of the SGS Group (Société Générale de Surveillance)



Test Report No. F690101/LF-CTSAYAA12-16422

Issued Date: 2012. 04. 30 Page 5 of 6

Testing Flow Chart for RoHS: Cd/Pb/Hg/Cr⁶⁺ /PBBs&PBDEs Testing

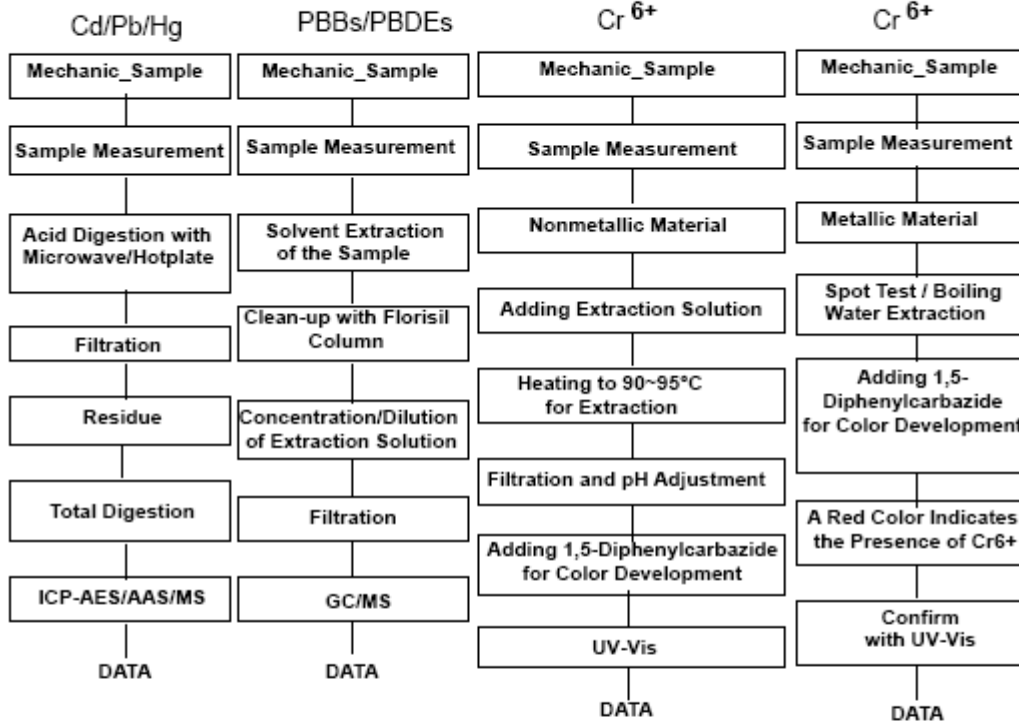

The samples were dissolved totally by pre-conditioning method according to above flow chart for Cd,Pb,Hg.
Section Chief : Gilsae Yi

- NOTE: (1) N.D. = Not detected.(<MDL)
 (2) mg/kg = ppm
 (3) MDL = Method Detection Limit
 (4) - = No regulation
 (5) Negative = Undetectable / Positive = Detectable
 (6) ** = Qualitative analysis (No Unit)
 (7) * = Boiling-water-extraction:
 Negative = Absence of CrVI coating
 Positive = Presence of CrVI coating; the detected concentration in boiling-water-extraction solution is equal or greater than 0.02 mg/kg with 50 cm² sample surface area.

This document is issued by the Company subject to its General Conditions of Service printed hereon, available on request or accessible at www.sgs.com/terms-and-conditions and, for electronic issued documents, subject to Terms and Conditions for Electronic Documents at www.sgs.com/terms-and-conditions. Attention is drawn to the limitation of liability, indemnification and jurisdiction clauses defined therein. Any notice of this document is deemed effective for the purposes stated herein. The Company's liability is limited to the extent of the Client's actual losses. The Client's sole responsibility is to its Client and this document does not constitute a contract or a warranty of any kind, and all rights and obligations under the document are reserved. This document cannot be reproduced except in full, without prior written approval of the Company. Unauthorised alteration, copying or falsification of the text or of any data contained in this document is prohibited and offences may be prosecuted in the fullest extent of the law. Values otherwise stated are results which indicate a typical value only (for sample tested) and each sample is analysed for 100 days only.

F052 Version4

SGS Korea Co., Ltd.

322, The O Valley, 505-6, Hoggae-dong, Gangseo-gu, Anyang-si, Gyeonggi-do, Korea 431-000
 T +82 (0)31 4828 000 F +82 (0)31 4828 059 <http://www.sgs.com/ks> www.kr.sgs.com/ks/ks.html

Member of the SGS Group (Società Generale di Servizi)

Flow Chart for Halogen Test

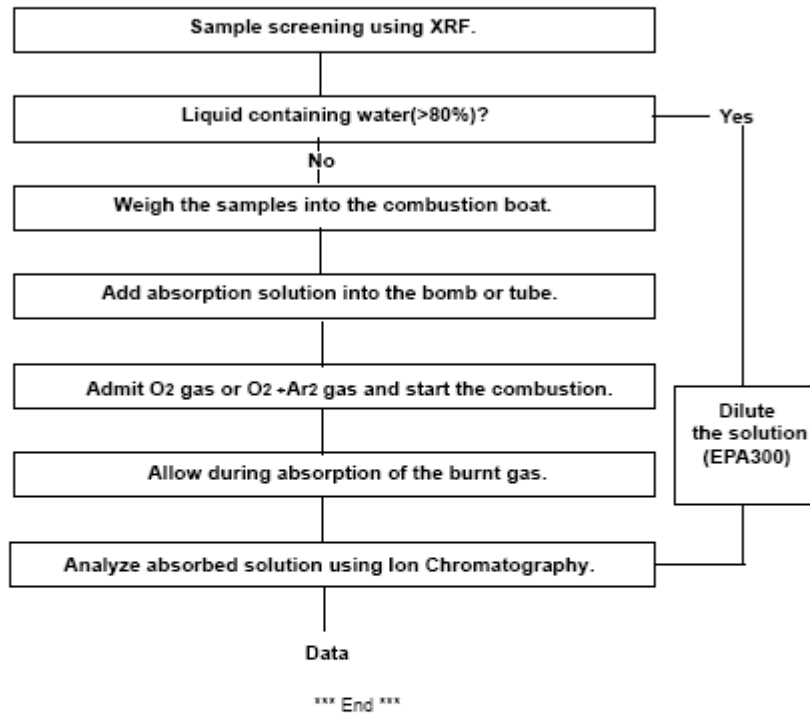

NOTE: (1) N.D. = Not detected.(<MDL)
 (2) mg/kg = ppm
 (3) MDL = Method Detection Limit
 (4) - = No regulation
 (5) Negative = Undetectable / Positive = Detectable
 (6) ** = Qualitative analysis (No Unit)
 (7) * = Boiling-water-extraction:
 Negative = Absence of CrVI coating
 Positive = Presence of CrVI coating; the detected concentration in boiling-water-extraction solution is equal or greater than 0.02 mg/kg with 50 cm2 sample surface area.

This document is issued by the Company subject to its General Conditions of Service printed elsewhere, available on request or accessible at www.sgs.com and www.sgs.com/sgs and for electronic format documents, subject to Terms and Conditions for Electronic Documents at www.sgs.com/sgs/electronic. Attention is drawn to the limitation of liability, indemnification and jurisdiction clause defined hereunder in any 100% of this document. It is recommended that the Client should consider these clauses in the Company's Policy at the time of its acceptance, only and make the Client's own independent judgement. Any use or reproduction of this document or any part thereof is prohibited and subject to the prior written approval of the Company. Unless otherwise stated the results shown in this report refer only to the sample(s) tested and such sample(s) are retained for 180 days only.

Test Method:

SGS In-House method - Analyzed by ICP-OES, PLM, UV/VIS, LC/MS ,GC/MS and colorimetric method

Remarks:

1. The chemical analysis of specified SVHC is performed by means of currently available analytical techniques against the following SVHC related documents published by ECHA:
<http://echa.europa.eu/web/guest/candidate-list-table> (Candidate list)
http://echa.europa.eu/en/web/guest/view-article/-/journal_content/69ec4c10-bd37-4ec9-ba3e-ad5b1bee766a (potential list)
These lists are under evaluation by ECHA and may subject to change in the future.
2. In accordance with Regulation (EC) No 1907/2006, any producer or importer of articles shall notify ECHA, in accordance with paragraph 2 of Article 7, if a substance meets the criteria in Article 57 and is identified in accordance with Article 59(1) of the Regulation, if (a) the substance is present in those articles in quantities totaling over one tonne per producer or importer per year; and (b) the substance is present in those articles above a concentration of 0.1% weight by weight (w/w).
3. Article 33 of Regulation (EC) No 1907/2006 requires supplier of an article containing a substance meeting the criteria in Article 57 and identified in accordance with Article 59(1) in a concentration above 0.1% weight by weight (w/w) shall provide the recipient of the article with sufficient information, available to the supplier, to allow safe use of the article including, as a minimum, the name of that substance in the Candidate List.
4. SGS adopts the interpretation of ECHA for SVHC in article unless indicated otherwise. Detail explanation is available at the following link:
- http://webstage.contribute.sgs.net/corpreach/documents/SGS-CTS_SVHC-paper-EN-11.pdf
5. Test results in this report are based on the tested sample. This report refers to testing result of composite material group by equal weight proportion. The material in each composite test group may come from one article.
6. If a SVHC is found over the reporting limit, client is suggested to identify the component which contains the SVHC and the exact concentration of the SVHC by requesting further quantitative analysis from the laboratory.

This document is issued by the Company subject to the General Conditions of Service (which are not) available on internet at www.sgs.com and/or electronic format documents, subject to Terms and Conditions for Electronic Documents at www.sgs.com. The Company is not responsible for the data and the document does not constitute a contract or a representation from anything of the rights and obligations under the terms of the document. This document cannot be reproduced except in full, without prior written approval of the Company. All unauthorized alterations, copying or distribution of the content or appearance of the document is prohibited and otherwise may be prosecuted to the full extent of the law. Please refer to the general conditions of service for the complete terms and conditions (http://www.sgs.com).

F052 Version4

SGS Korea Co., Ltd.

322, The Ovalley, 555-9, Hoggae-dong, Daejeon-gu, Anyang-si, Gyeonggi-do, Korea 431-080
t +82 (0)31 4908 000 f +82 (0)31 4908 059 <http://www.sgs.com> sgs@sgs.com

Member of the SGS Group (Société Générale de Surveillance)

Test Result(s)

Substance Name	CAS number	EC number	Concentration (%)	Reporting Limit (%)	Classification
Alkanes, C10-13, chloro (Short Chain Chlorinated Paraffins)	85535-84-8	287-476-5	N.D.	0.05	PBT
Anthracene	120-12-7	204-371-1	N.D.	0.05	PBT
Benzyl butyl phthalate (BBP)	85-68-7	201-622-7	N.D.	0.05	Toxic for Reproduction
Bis (2-ethylhexylphthalate) (DEHP)	117-81-7	204-211-0	N.D.	0.05	Toxic for Reproduction
Bis(tributyltin)oxide	56-35-9	200-268-0	N.D.	0.05	PBT
Cobalt dichloride*	7646-79-9	231-589-4	N.D.	0.005	Carcinogen Toxic for Reproduction
4,4-Diaminodiphenylmethane	101-77-9	202-974-4	N.D.	0.05	Carcinogen
Diarsenic pentaoxide*	1303-28-2	215-116-9	N.D.	0.005	Carcinogen
Diarsenic trioxide*	1327-53-3	215-481-4	N.D.	0.005	Carcinogen
Dibutyl phthalate (DBP)	84-74-2	201-557-4	N.D.	0.05	Toxic for Reproduction
Hexabromocyclo-dodecane (HBCDD) and all major diastereoisomers identified (α-HBCDD, β-HBCDD, γ-HBCDD)	25637-99-4 and 3194-55-6 (134237-51-7, 134237-50-6, 134237-52-8)	247-148-4 and 221-695-9	N.D.	0.05	PBT
Lead hydrogen arsenate*	7784-40-9	232-064-2	N.D.	0.005	Carcinogen Toxic for Reproduction
Sodium dichromate (Sodium dichromate, dehydrate)	10588-01-9 (7789-12-0)	234-190-3	N.D.	0.005	Carcinogen Mutagen Toxic for Reproduction
5-tert-butyl-2,4,6-trinitro-m-xylene (musk xylene)	81-15-2	201-329-4	N.D.	0.05	vPvB
Triethyl arsenate*	15606-95-8	427-700-2	N.D.	0.005	Carcinogen

This document is issued by the Company subject to the General Conditions of Service printed hereon, or available on request at www.sgs.com, and its electronic format documents, subject to Terms and Conditions for Electronic Documents at www.sgs.com. It is the property of SGS and its confidentiality is guaranteed. It is not to be used for any other purpose than that for which it was issued. The Company's liability is limited to the amount of the fee paid for the analysis. The Company is not responsible for the Client and the document does not constitute a guarantee of the results. All rights and obligations under the terms of the document are reserved. The document cannot be reproduced, stored, or otherwise used in any way without the prior written approval of the Company. All intellectual property rights are reserved. The content of this document is confidential and disclosure may be prosecuted in the future without notice. Changes in the content of this document may occur without notice.

F092 Version4

SGS Korea Co., Ltd.

 322, The Ovalley, 555-9, Hoggae-dong, Dongan-gu, Anyang-si, Gyeonggi-do, Korea 431-080
 t +82 (0)31 4905 000 f +82 (0)31 4006 059 <http://www.sgs.com> sgs@sgs.com

Member of the SGS Group (Société Générale de Surveillance)

Substance Name	CAS number	EC number	Concentration (%)	Reporting Limit (%)	Classification
Di-isobutyl phthalate(DIBP)	84-69-5	201-553-2	N.D.	0.05	Toxic for Reproduction
2,4-Dinitrotoluene	121-14-2	204-450-0	N.D.	0.05	Carcinogen
Tris(2-chloroethyl) phosphate	115-96-8	204-118-5	N.D.	0.05	Toxic for Reproduction
Anthracene oil	90640-80-5	292-602-7	N.D.	0.05	PBT; vPvB Carcinogen
Anthracene oil, anthracene paste; distn. Lights	91995-17-4	295-278-5	N.D.	0.05	PBT; vPvB Carcinogen Mutagen
Anthracene oil, anthracene paste, anthracene fraction	91995-15-2	295-275-9	N.D.	0.05	PBT; vPvB Carcinogen Mutagen
Anthracene oil, anthracene-low	90640-82-7	292-604-8	N.D.	0.05	PBT; vPvB Carcinogen Mutagen
Anthracene oil, anthracene paste	90640-81-6	292-603-2	N.D.	0.05	PBT; vPvB Carcinogen Mutagen
Coal tar pitch, high temperature	65996-93-2	266-028-2	N.D.	0.05	PBT; vPvB Carcinogen
Aluminosilicate, Refractory Ceramic Fibres*	650-017-00-8 (Index no.)	-	N.D.	0.005	Carcinogen
Zirconia Aluminosilicate, Refractory Ceramic Fibres*	650-017-00-8 (Index no.)	-	N.D.	0.005	Carcinogen
Lead sulfochromate yellow (C.I. Pigment Yellow 34)*	1344-37-2	215-693-7	N.D.	0.005	Carcinogen Toxic for Reproduction
Lead chromate molybdate sulfate red (C.I. Pigment Red 104)*	12656-85-8	235-759-9	N.D.	0.005	Carcinogen Toxic for Reproduction
Lead chromate*	7758-97-6	231-846-0	N.D.	0.005	Carcinogen Toxic for Reproduction
Acrylamide	79-06-01	201-173-7	N.D.	0.05	Carcinogen Mutagen

This document is issued by the Company subject to the General Conditions of Service printed attached, available on request or accessible at www.sgs.com and its electronic format documents, subject to Terms and Conditions for Electronic Documents at www.sgs.com. Any other information of liability, indemnification and jurisdiction shall be subject to the applicable law. SGS is not liable for any damage or loss of data or information caused by the use of the Company's services or the transmission, copy and/or the use of the data or information. The Company's sole responsibility is to the Client and the document does not constitute a contract or a representation or warranty of any kind. The document is issued under the Company's documents. This document cannot be reproduced except in full, without prior written approval of the Company. All unauthorised alterations, copying or distribution of this content on any medium is strictly prohibited and will be prosecuted to the full extent of the law.

F082 Version4

SGS Korea Co., Ltd.

 322, The Ovalley, 555-9, Hoggw-dong, Dongan-gu, Anyang-si, Gyeonggi-do, Korea 431-080
 (+82) (0)31 4928 000 F +82 (0)31 4930 059 <http://www.sgs.com> sgs@sgs.com

Member of the SGS Group (Société Générale de Surveillance)

Substance Name	CAS number	EC number	Concentration (%)	Reporting Limit (%)	Classification
Boric acid*	10043-35-3 11113-50-1	233-139-2 234-343-4	N.D.	0.005	Toxic for Reproduction
Disodium tetraborate, anhydrous*	1330-43-4 12179-04-3 1303-96-4	215-540-4	N.D.	0.005	Toxic for Reproduction
Tetraboron disodium heptaoxide, hydrate*	12267-73-1	235-541-3	N.D.	0.005	Toxic for Reproduction
Trichloroethylene	79-01-6	201-167-4	N.D.	0.05	Carcinogen
Sodium chromate*	7775-11-3	231-889-5	N.D.	0.005	Carcinogen Mutagen Toxic for Reproduction
Ammonium dichromate*	7789-09-5	232-143-1	N.D.	0.005	Carcinogen Mutagen Toxic for Reproduction
Potassium dichromate*	7778-50-9	231-906-6	N.D.	0.005	Carcinogen Mutagen Toxic for Reproduction
Potassium chromate*	7789-00-6	232-140-5	N.D.	0.005	Carcinogen Mutagen

This document is issued by the Company subject to the General Conditions of Service printed hereon, available on request or accessible at www.sgs.com and its electronic format documents, subject to Terms and Conditions for Electronic Documents at www.sgs.com. Attention is drawn to the limitation of liability, indemnification and jurisdiction clauses defined therein. Any holder of this document is advised that the information contained herein reflects the Company's findings, it is not to be taken as an indication of the quality of the work performed by the Company, it is not to be taken as an indication of the Company's responsibility for the Client and the document does not constitute any representation made by the Company or its subsidiaries. This document cannot be reproduced, stored in a retrieval system, or transmitted in any form or by any means, electronic, mechanical, photocopying, recording, or by any information storage and retrieval system, without the prior written permission of the Company. All unauthorized alterations, copying or distribution without consent or appearance of the document is prohibited and otherwise may be prosecuted to the fullest extent of the law. Please refer to the attached file for the complete terms and conditions available at www.sgs.com.

F052 Version4

SGS Korea Co., Ltd.

 322, The Ovalley, 555-9, Hoggae-dong, Dongan-gu, Anyang-si, Gyeonggi-do, Korea 431-080
 t+82 (0)31 4928 000 f+82 (0)31 4008 059 <http://www.sgs.com> <http://www.sgs.com/sgslab>

Member of the SGS Group (Société Générale de Surveillance)

Substance Name	CAS number	EC number	Concentration (%)	Reporting Limit (%)	Classification
Cobalt(II) sulphate*	10124-43-3	233-334-2	N.D.	0.005	Carcinogen Toxic for Reproduction
Cobalt(II) dinitrate*	10141-05-6	233-402-1	N.D.	0.005	Carcinogen Toxic for Reproduction
Cobalt(II) carbonate*	513-79-1	208-169-4	N.D.	0.005	Carcinogen Toxic for Reproduction
Cobalt(II) diacetate*	71-48-7	200-755-8	N.D.	0.005	Carcinogen Toxic for Reproduction
2-Methoxyethanol	109-86-4	203-713-7	N.D.	0.05	Toxic for Reproduction
2-Ethoxyethanol	110-80-5	203-804-1	N.D.	0.05	Toxic for Reproduction
Chromium trioxide*	1333-82-0	215-607-8	N.D.	0.005	Carcinogen Mutagen
Acids generated from chromium trioxide and their oligomers:					
Chromic acid	7738-94-5	231-801-5	N.D.	0.005	Carcinogen
Dichromic acid	13530-68-2	236-881-5			
Oligomers of chromic acid and dichromic acid'	-	-			
1-methyl-2-pyrrolidone	872-50-4	212-828-1	N.D.	0.05	Toxic for Reproduction
2-ethoxyethyl acetate	111-15-9	203-839-2	N.D.	0.05	Toxic for Reproduction
1,2-benzenedicarboxylic acid, di-C6-8-branched alkyl esters, C7-rich	71888-89-6	276-158-1	N.D.	0.05	Toxic for Reproduction
1,2-benzenedicarboxylic acid, di-C7-11-branched and linear alkyl esters	68515-42-4	271-084-6	N.D.	0.05	Toxic for Reproduction
1,2,3-trichloropropane	96-18-4	202-486-1	N.D.	0.05	Carcinogen Toxic for Reproduction
Hydrazine	7803-57-8 302-01-2	206-114-9	N.D.	0.05	Carcinogen
Strontium chromate*	7789-06-2	232-142-6	N.D.	0.005	Carcinogen

The document is issued by the Company subject to the General Conditions of Service printed attached, available on request or accessible at www.sgs.com/sgs-portal and, in electronic format documents subject to Terms and Conditions for Electronic Documents at www.sgs.com/sgs-portal. Attention is drawn to the limitation of liability, identification and production issues defined therein. Any failure of the Client to comply with the instructions contained herein may affect the Company's ability to perform its obligations in accordance with the terms of this document. It is the Client's sole responsibility to verify the data and the documents that are generated as a result of this service. The Company shall not be liable for any errors or omissions in this document and the Client may be prosecuted in the future. The Client shall be deemed to have accepted the results of this service (and all such services) in accordance with the terms of this document. This document cannot be reproduced except in full, without prior written approval of the Company. All unauthorized reproduction, copying, distribution or appearance in this document is prohibited and may be prosecuted in the future. www.sgs.com

F052 Version4

SGS Korea Co., Ltd.

322, The Ovalley, 525-9, Hoge-dong, Dongae-gu, Anyang-si, Gyeonggi-do, Korea 431-080
t +82 (0)31 4926 9000 f +82 (0)31 4926 059 <http://www.sgslab.co.kr> www.kr.sgs.com www.sgslab.com

Member of the SGS Group (Société Générale de Surveillance)

Substance Name	CAS number	EC number	Concentration (%)	Reporting Limit (%)	Classification
1,2-Dichloroethane	107-06-2	203-458-1	N.D.	0.05	Carcinogenic
2,2'-dichloro-4,4'-methylenedianiline (MOCA)	101-14-4	202-918-9	N.D.	0.05	Carcinogenic
2-Methoxyaniline o-Anisidine	90-04-0	201-963-1	N.D.	0.05	Carcinogenic
4-(1,1,3,3-tetramethylbutyl)phenol, (4-tert-Octylphenol)	140-66-9	205-426-2	N.D.	0.05	Equivalent level of concern having probable serious effects to the environment
Aluminosilicate Refractory Ceramic Fibres* (RCF)	650-017-00-8 (Index no.)	-	N.D.	0.005	Carcinogenic
Arsenic acid*	7778-39-4	231-901-9	N.D.	0.005	Carcinogenic
Bis(2-methoxyethyl) ether	111-96-6	203-924-4	N.D.	0.05	Toxic for reproduction
Bis(2-methoxyethyl) phthalate	117-82-8	204-212-6	N.D.	0.05	Toxic for reproduction
Calcium arsenate*	7778-44-1	231-904-5	N.D.	0.005	Carcinogenic
Dichromium tris(chromate)*	24613-89-6	246-356-2	N.D.	0.005	Carcinogenic
Formaldehyde, oligomeric reaction products with aniline (technical MDA)	25214-70-4	500-036-1	N.D.	0.05	Carcinogenic
Lead diazide*	13424-46-9	236-542-1	N.D.	0.005	Toxic for reproduction
Lead dipicrate*	6477-64-1	229-335-2	N.D.	0.005	Toxic for reproduction
Lead styphnate*	15245-44-0	239-290-2	N.D.	0.005	Toxic for reproduction
N,N-dimethylacetamide (DMAC)	127-19-5	204-826-4	N.D.	0.05	Toxic for reproduction
Pentazine chromate octahydroxide*	49663-84-5	256-418-0	N.D.	0.005	Carcinogenic
Phenolphthalein	77-09-8	201-004-7	N.D.	0.05	Carcinogenic
Potassium hydroxycyctaooxidzincatedichromate*	11103-86-9	234-329-8	N.D.	0.005	Carcinogenic
Trilead diarsenate*	3687-31-8	222-979-5	N.D.	0.005	Carcinogenic Toxic for reproduction
Zirconia Aluminosilicate Refractory Ceramic Fibres (Zr-RCF)*	650-017-00-8 (Index no.)	-	N.D.	0.005	Carcinogenic

This document is issued by the Company within its Standard Conditions of Service (initial analysis), available on request at www.sgs.com, and its electronic format documents subject to Terms and Conditions for Electronic Documents at www.sgs.com. Member is drawn to the attention of safety, transportation and production laws applicable in the country of origin. This document is intended for information purposes only. The Company's sole responsibility is to the Client and this document does not constitute an offer or a contract. Any liability arising from this document is the sole responsibility of the Client. This document cannot be applied except in full, without prior written approval of the Company. Any unauthorized alteration, forgery or falsification of the content or appearance of this document is illegal and therefore may be prosecuted in the future. All rights reserved. All other trademarks belong to their respective holders. All rights reserved. All other trademarks belong to their respective holders.

F052 Version4

SGS Korea Co., Ltd.

 322, The Ovalley, 555-9, Hogeje-dong, Dongan-gu, Anyang-si, Gyeonggi-do, Korea 431-080
 (+82) (0)31 4925 900 F +82 (0)31 4926 059 <http://www.sgs.com> www.kr.sgs.com sgs@sgs.com

Member of the SGS Group (Société Générale de Surveillance)

The potential Substances

Substance Name	CAS number	EC number	Concentration (%)	Reporting Limit (%)	Classification
1,2-bis(2-methoxyethoxy)ethane (TEGDME; triglyme)	112-49-2	203-977-3	N.D.	0.05	Toxic for reproduction
1,2-dimethoxyethane;ethylene glycol dimethyl ether (EGDME)	110-71-4	203-794-9	N.D.	0.05	Toxic for reproduction
Diboron trioxide*	1303-86-2	215-125-8	N.D.	0.005	Toxic for reproduction
Formamide	75-12-7	200-842-0	N.D.	0.05	Toxic for reproduction
Lead(II) bis(methanesulfonate)*	17570-76-2	401-750-5	N.D.	0.005	Toxic for reproduction
TGIC(1,3,5-tris(oxiranylmethyl)-1,3,5-triazine-2,4,6-(1H,3H,5H)-trione)	2451-62-9	219-514-3	N.D.	0.05	Mutagenic
β-TGIC (1,3,5-tris[(2S and 2R)-2,3-epoxypropyl]-1,3,5-triazine-2,4,6-(1H,3H,5H)-trione)	59653-74-6	423-400-0	N.D.	0.05	Mutagenic
4,4'-bis(dimethylamino)benzophenone (Michler's ketone)	90-94-8	202-027-5	N.D.	0.05	Carcinogenic
N,N,N,N-tetramethyl-4,4'-methylenedianiline (Michler's base)	101-61-1	202-969-2	N.D.	0.05	Carcinogenic
[4-[4,4'-bis(dimethylamino)benzhydrylidene]cyclohexa-2,5-dien-1-ylidene]dimethylammonium chloride (C.I. Basic Violet 3)	548-62-9	208-963-6	N.D.	0.05	Carcinogenic
[4-[[4-anilino-1-naphthyl][4-(dimethylamino)phenyl]methylene]cyclohexa-2,5-dien-1-ylidene]dimethylammonium chloride (C.I. Basic Blue 26)	2580-56-5	219-943-6	N.D.	0.05	Carcinogenic
α,α-Bis[4-(dimethylamino)phenyl]-4(phenylamino)naphthalene-1-methanol (C.I. Solvent Blue 4)	6786-83-0	229-851-8	N.D.	0.05	Carcinogenic
4,4'-bis(dimethylamino)-4'-(methylamino)trityl alcohol	561-41-1	209-218-2	N.D.	0.05	Carcinogenic

This document is issued by the Company subject to the Standard Conditions of Service printed elsewhere, available on request at www.sgs.com and www.sgs.com/sgsnet, and to the Methods listed documents, subject to Terms and Conditions for Methods Documents at www.sgs.com/sgsnet. Any reference to the identification of testing, identification and analysis shall be subject to the rules and conditions of the Company's standard conditions of service, which are available on request from the Company's website. It is intended for use only and unless the terms of the Standard Conditions of Service apply, the Company's sole responsibility is to the Client and the document does not constitute an acceptance of any liability or obligation under the transaction documents. This document cannot be reproduced except in full, without prior written consent of the Company. Any unauthorized reproduction, storage or distribution of this document is prohibited and may be prosecuted in the courts of law.

F052 Version4

SGS Korea Co., Ltd.

 322, The Ovalley, 555-9, Hoggae-dong, Daejeon-gu, Aseong-ei, Gyeonggi-do, Korea 431-080
 T+82 (0)31 4928 900 F +82 (0)31 4928 059 <http://www.sgs.com> www.sgs.com/sgsnet

Member of the SGS Group (Société Générale de Surveillance)

Note:

1. RL – Reporting Limit

2. N.D. – Not detected (lower than RL)

NA. – Not applicable for respective material type.

The submitted sample was found to contain significant amount of specific element(s) of SVHC. Upon further test verification and also information provided from client, the possibility that the element(s) content originate from SVHC is very unlikely, even though their presence cannot be exclude entirely. It may be assumed that the detected element(s) have a non-SVHC source.

3. Definition of classification is listed in Appendix A of this report in accordance with 67/548/EEC and Regulation (EC) No 1907/2006. For detail information, Detail explanation is available at the following link:

<http://echa.europa.eu/web/quest/candidate-list-table> (Candidate list)

http://echa.europa.eu/en/web/quest/view-article/-/journal_content/69ec4c10-bd37-4ec9-ba3e-ad5b1bee766a (potential list)

4. *.The test result is based on the calculation of selected element(s) / marker(s) and to the worst-case scenario. For detail information, please refer to the SGS REACH website: www.reach.sgs.com/substance-of-very-high-concern-analysis-information-page.htm

The client is advised to review the chemical formulation to ascertain above metal substances present in the article.

RL = 0.005% is evaluated for element (i.e. cobalt, arsenic, lead, sodium, chromium, chromium(VI), silicon, aluminum, zirconium, boron, and potassium respectively), except molybdenum RL=0.0005%

0.1% (w/w) = 1,000 ppm = 1,000 mg/kg



*** End of Report ***

This document is issued by the Company subject to the General Conditions of Service which are available on request at www.sgs.com and the Methods of Service which are available on request at www.sgs.com. The Company's responsibility is to the Client and the document does not constitute an offer of insurance or any other financial product. The document is for the Client's use only and the Client is responsible for the accuracy of the information provided. The document is for the Client's use only and the Client is responsible for the accuracy of the information provided. The document is for the Client's use only and the Client is responsible for the accuracy of the information provided.

F052 Version

SGS Korea Co., Ltd.

322, The Ovalley, 855-6, Hoge-dong, Dongan-gu, Anyang-si, Gyeonggi-do, Korea 431-060
T +82 (0)31 4935 0000 F +82 (0)31 4935 0500 <http://www.sgs.com> sgs@sgs.com

Member of the SGS Group (Società Globale di Sorveglianza)

Appendix A

Classification	Definition under 67/548/EEC and Regulation (EC) No 1907/2006
Carcinogen Category 1:	<u>Substances known to be carcinogenic to man.</u> There is sufficient evidence to establish a causal association between human exposure to a substance and the development of cancer.
Carcinogen Category 2:	<u>Substances which should be regarded as if they are carcinogenic to man.</u> There is sufficient evidence to provide a strong presumption that human exposure to a substance may result in the development of cancer. Generally on the basis of: - appropriate long-term animal studies - other relevant information.
Mutagen Category 1:	<u>Substances known to be mutagenic to man.</u> There is sufficient evidence to establish a causal association between human exposure to a substance and heritable genetic damage.
Mutagen Category 2:	<u>Substances which should be regarded as if they are mutagenic to man.</u> There is sufficient evidence to provide a strong presumption that human exposure to the substance may result in the development of heritable genetic damage, generally on the basis of: - appropriate animal studies, - other relevant information.
Toxic to Reproduction Category 1:	<u>Substances known to impair fertility in humans.</u> There is sufficient evidence to establish a causal relationship between human exposure to the substance and impaired fertility. <u>Substances known to cause developmental toxicity in humans.</u> There is sufficient evidence to establish a causal relationship between human exposure to the substance and subsequent developmental toxic effects in the progeny.
Toxic to Reproduction Category 2:	<u>Substances which should be regarded as if they impair fertility in humans.</u> There is sufficient evidence to provide a strong presumption that human exposure to the substance may result in impaired fertility on the basis of: - clear evidence in animal studies of impaired fertility in the absence of toxic effects, or, evidence of impaired fertility occurring at around the same dose levels as other toxic effects but which is not a secondary nonspecific consequence of the other toxic effects, - other relevant information. <u>Substances which should be regarded as if they cause developmental toxicity to humans.</u> There is sufficient evidence to provide a strong presumption that human exposure to the substance may result in developmental toxicity, generally on the basis of: - clear results in appropriate animal studies where effects have been observed in the absence of signs of marked maternal toxicity, or at around the same dose levels as other toxic effects but which are not a secondary non-specific consequence of the other toxic effects, - other relevant information.
PBT & vPvB:	Substances which are persistent, bioaccumulative and toxic (PBT) or very persistent and very bioaccumulative (vPvB) pose a particular challenge to the chemicals safety management. For these substances a "safe" concentration in the environment cannot be established with sufficient reliability.

This document is issued by the Company subject to the General Conditions of Service printed on the back, available on request or accessible at www.sgs.com/sgsweb/sgsweb.nsf/0 with the following terms: documents, subject to Terms and Conditions for Electronic Documents at www.sgs.com/sgsweb/sgsweb.nsf/0. The Company is not responsible for the data and the document data on accuracy or for a representation made according to their rights and obligations under the respective documents. This document cannot be reproduced except in full, without prior written approval of the Company. All unauthorized alterations, copies and distribution of this content or appearance in this document is prohibited and offences may be prosecuted to the full extent of the law. Unless otherwise stated the results shown in this report apply only to the sample(s) named and each sample(s) are not valid for 180 days only.

Substance Name	CAS number	EC number	Concentration (%)	Reporting Limit (%)	Classification
Dioxobis(stearato)trilead*	12578-12-0	235-702-8	N.D.	0.005	Toxic for reproduction
Fatty acids, C16-18, lead salts*	91031-62-8	292-966-7	N.D.	0.005	Toxic for reproduction
Lead bis(tetrafluoroborate)*	13814-96-5	237-486-0	N.D.	0.005	Toxic for reproduction
Lead cyanamidate*	20837-86-9	244-073-9	N.D.	0.005	Toxic for reproduction
Lead dinitrate*	10099-74-8	233-245-9	N.D.	0.005	Toxic for reproduction
Lead oxide (lead monoxide)*	1317-36-8	215-267-0	N.D.	0.005	Toxic for reproduction
Lead tetroxide (orange lead)*	1314-41-6	215-235-6	N.D.	0.005	Toxic for reproduction
Lead titanium trioxide*	12060-00-3	235-038-9	N.D.	0.005	Toxic for reproduction
Lead Titanium Zirconium Oxide*	12626-81-2	235-727-4	N.D.	0.005	Toxic for reproduction
Pentalead tetroxide sulphate*	12065-90-6	235-067-7	N.D.	0.005	Toxic for reproduction
Pyrochlore, antimony lead yellow*	8012-00-8	232-382-1	N.D.	0.005	Toxic for reproduction
Silicic acid, barium salt, lead-doped*	68784-75-8	272-271-5	N.D.	0.005	Toxic for reproduction
Silicic acid, lead salt*	11120-22-2	234-363-3	N.D.	0.005	Toxic for reproduction
Sulfurous acid, lead salt, dibasic*	62229-08-7	263-467-1	N.D.	0.005	Toxic for reproduction
Tetraethyllead*	78-00-2	201-075-4	N.D.	0.005	Toxic for reproduction
Tetralead trioxide sulphate*	12202-17-4	235-380-9	N.D.	0.005	Toxic for reproduction

This document is issued by the Company subject to its General Conditions of Service printed hereon, available on request or accessible at <http://www.sgs.com/en/Terms-and-Conditions.aspx> and, for electronic format documents, subject to Terms and Conditions for Electronic Documents at <http://www.sgs.com/en/e-document.aspx>. Attention is drawn to the limitation of liability, indemnification and jurisdiction issues defined therein. Any holder of this document is advised that information contained hereon reflects the Company's findings at the time of its issuance only and within the limits of C-100's instructions, if any. The Company's sole responsibility is to its Client and the document does not constitute part of a transaction nor is it a warranty or a guarantee under the transaction documents. This document cannot be reproduced except in full, without prior written approval of the Company. Any unauthorized alteration, forgery or falsification of the content or appearance of this document is unlawful and offenders may be prosecuted to the fullest extent of the law. Unless otherwise stated the results shown in this test report refer only to the samples tested and such samples are retained for 30 days only.

F052 Version 5

SGS Korea Co., Ltd.

322, The Ovaltoy, 555-5, Hoggae-dong, Dongan-gu, Anyang-si, Gyeonggi-do, Korea 431-080
t +82 (0)31 4808 000 f +82 (0)31 4608 050 <http://www.sgs.co.kr> www.kr.sgs.com/practlab

Member of the SGS Group (Société Générale de Surveillance)

Substance Name	CAS number	EC number	Concentration (%)	Reporting Limit (%)	Classification
Trilead dioxide phosphonate*	12141-20-7	235-252-2	N.D.	0.005	Toxic for reproduction
Furan	110-00-9	203-727-3	N.D.	0.05	Carcinogenic
Propylene oxide; 1,2-epoxypropane; methyloxirane	75-56-9	200-879-2	N.D.	0.05	Carcinogenic Mutagenic
Diethyl sulphate	64-67-5	200-589-6	N.D.	0.05	Carcinogenic Mutagenic
Dimethyl sulphate	77-78-1	201-058-1	N.D.	0.05	Carcinogenic
3-ethyl-2-methyl-2-(3-methylbutyl)-1,3-oxazolidine	143860-04-2	421-150-7	N.D.	0.05	Toxic for reproduction
Dinoseb	88-85-7	201-861-7	N.D.	0.05	Toxic for reproduction
4,4'-methylenedi-o-toluidine	838-88-0	212-658-8	N.D.	0.05	Carcinogenic
4,4'-oxydianiline and its salts	101-80-4	202-977-0	N.D.	0.05	Carcinogenic Mutagenic
4-Aminoazobenzene; 4-Phenylazoaniline	60-09-3	200-453-6	N.D.	0.05	Carcinogenic
4-methyl-m-phenylenediamine (2,4-toluene-diamine)	95-80-7	202-453-1	N.D.	0.05	Carcinogenic
6-methoxy-m-toluidine (p-cresidine)	120-71-8	204-419-1	N.D.	0.05	Carcinogenic
Biphenyl-4-ylamine	92-67-1	202-177-1	N.D.	0.05	Carcinogenic
o-aminoazotoluene	97-56-3	202-591-2	N.D.	0.05	Carcinogenic
o-Toluidine; 2-Aminotoluene	95-53-4	202-429-0	N.D.	0.05	Carcinogenic
N-methylacetamide	79-16-3	201-182-6	N.D.	0.05	Toxic for reproduction
1-bromopropane; n-propyl bromide	106-94-5	203-445-0	N.D.	0.05	Toxic for reproduction

This document is issued by the Company subject to its General Conditions of Service printed hereon, available on request or accessible at <http://www.sgs.com/en/TermsandConditions.aspx>, and, for electronic format documents, subject to Terms and Conditions for Electronic Documents at <http://www.sgs.com/en/e-document.htm>. Attention is drawn to the limitation of liability, indemnification and jurisdiction clause defined therein. Any holder of this document is advised that information contained herein reflects the Company's findings at the time of its issuance only and within the limits of C-100's mandate, if any. The Company's sole responsibility is to its Client and this document does not constitute advice to a transaction from or carry all other rights and obligations under the transaction documents. This document cannot be reproduced except in full, without prior written approval of the Company. Any unauthorised alteration, forgery or falsification of the content or appearance of this document is criminal and offenders may be prosecuted to the fullest extent of the law. Unless otherwise stated the results shown in this test report refer only to the sample(s) tested and such sample(s) are retained for 30 days only.

F052 Version 5

SGS Korea Co., Ltd.

 322, The Ovalley, 555-5, Hoggya-dong, Dongan-gu, Anyang-si, Gyeonggi-do, Korea 431-080
 t +82 (0)31 4803 000 f +82 (0)31 4608 059 <http://www.sgslab.co.kr> www.kr.sgs.com/sgsenglish

Member of the SGS Group (Société Générale de Surveillance)

Note:

1. RL = Reporting Limit

2. N.D. = Not detected (lower than RL)

N.A. = Not applicable for respective material type.

The submitted sample was found to contain significant amount of specific element(s) of SVHC. Upon further test verification and also information provided from client, the possibility that the element(s) content originate from SVHC is very unlikely, even though their presence cannot be exclude entirely. It may be assumed that the detected element(s) have a non-SVHC source.

3. Definition of classification is listed in Appendix A of this report in accordance with 67/548/EEC and Regulation (EC) No 1907/2006. For detail information, Detail explanation is available at the following link:

<http://echa.europa.eu/web/quest/candidate-list-table> (Candidate list)

http://echa.europa.eu/en/web/quest/view-article/-/journal_content/512b7526-9dd6-4872-934e-8c298c89ad99 (Potential list)

4. *.The test result is based on the calculation of selected element(s) / marker(s) and to the worst-case scenario. For detail information, please refer to the SGS REACH website: www.reach.sgs.com/substance-of-very-high-concern-analysis-information-page.htm

The client is advised to review the chemical formulation to ascertain above metal substances present in the article.

RL = 0.005% is evaluated for element (i.e. cobalt, arsenic, lead, sodium, chromium, chromium(VI), silicon, aluminum, zirconium, boron, and potassium respectively), except molybdenum RL=0.0005%

0.1% (w/w) = 1,000 ppm = 1,000 mg/kg

5. **.β-TGIC is one of the isomers for TGIC compounds and hence, tested together. The reported test result is based the proposed ratio as according to ECHA dossier.

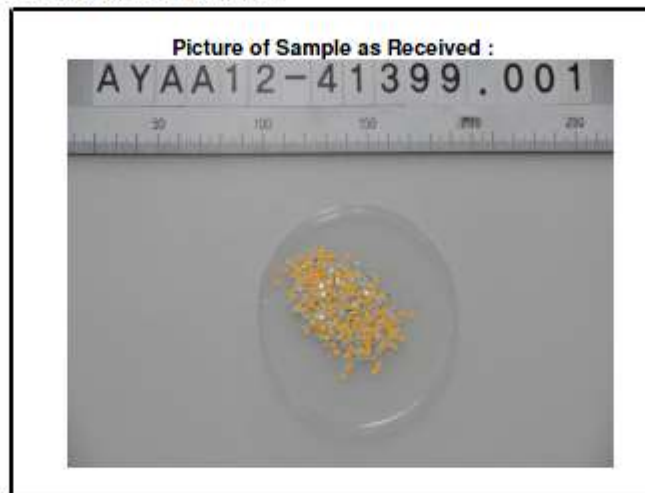

*** End of Report ***

This document is issued by the Company subject to its General Conditions of Service printed overleaf, available on request or accessible at http://www.sgs.com/en/Terms-and-Conditions_sgs_en, for electronic format documents, subject to Terms and Conditions for Electronic Documents at http://www.sgs.com/en/e-document_sgs. Attention is drawn to the limitation of liability, indemnification and jurisdiction issues defined therein. Any holder of this document is advised that its content is subject to the Company's findings at the time of its generation only and within the limits of the Client's instructions, if any. The Company's sole responsibility is to its Client and this document does not constitute part of a transaction nor is it binding on either party. The document cannot be reproduced except in full, without prior written approval of the Company. Any unauthorized alteration, forgery or falsification of the content or appearance of this document is criminal and offenders may be prosecuted to the fullest extent of the law. Unless otherwise stated the results shown in the test report refer only to the sample(s) tested and such sample(s) are retained for 90 days only.

F052 Version 5

SGS Korea Co., Ltd.

322, The Ovalley, 555-9, Hoge-dong, Dongan-gu, Anyang-si, Gyeonggi-do, Korea 431-080
t +82 (0)31 4608 000 f +82 (0)31 4608 050 <http://www.sgslab.co.kr> www.kr.sgs.com/jrcsrlab

Member of the SGS Group (Società Ginevrina de Surveillance)

Appendix A

Classification	Definition under 67/548/EEC and Regulation (EC) No 1907/2006
Carcinogen Category 1:	<u>Substances known to be carcinogenic to man.</u> There is sufficient evidence to establish a causal association between human exposure to a substance and the development of cancer.
Carcinogen Category 2:	<u>Substances which should be regarded as if they are carcinogenic to man.</u> There is sufficient evidence to provide a strong presumption that human exposure to a substance may result in the development of cancer. Generally on the basis of: - appropriate long-term animal studies - other relevant information.
Mutagen Category 1:	<u>Substances known to be mutagenic to man.</u> There is sufficient evidence to establish a causal association between human exposure to a substance and heritable genetic damage.
Mutagen Category 2:	<u>Substances which should be regarded as if they are mutagenic to man.</u> There is sufficient evidence to provide a strong presumption that human exposure to the substance may result in the development of heritable genetic damage, generally on the basis of: - appropriate animal studies, - other relevant information.
Toxic to Reproduction Category 1:	<u>Substances known to impair fertility in humans.</u> There is sufficient evidence to establish a causal relationship between human exposure to the substance and impaired fertility. <u>Substances known to cause developmental toxicity in humans.</u> There is sufficient evidence to establish a causal relationship between human exposure to the substance and subsequent developmental toxic effects in the progeny.
Toxic to Reproduction Category 2:	<u>Substances which should be regarded as if they impair fertility in humans.</u> There is sufficient evidence to provide a strong presumption that human exposure to the substance may result in impaired fertility on the basis of: - clear evidence in animal studies of impaired fertility in the absence of toxic effects, or, evidence of impaired fertility occurring at around the same dose levels as other toxic effects but which is not a secondary nonspecific consequence of the other toxic effects, - other relevant information. <u>Substances which should be regarded as if they cause developmental toxicity to humans.</u> There is sufficient evidence to provide a strong presumption that human exposure to the substance may result in developmental toxicity, generally on the basis of: - clear results in appropriate animal studies where effects have been observed in the absence of signs of marked maternal toxicity, or at around the same dose levels as other toxic effects but which are not a secondary non-specific consequence of the other toxic effects, - other relevant information.
PBT & vPvB:	Substances which are persistent, bioaccumulative and toxic (PBT) or very persistent and very bioaccumulative (vPvB) pose a particular challenge to the chemicals safety management. For these substances a "safe" concentration in the environment cannot be established with sufficient reliability.

The document is issued by the Company subject to its General Conditions of Service printed herein, available on request or accessible at <http://www.sgs.com/en/Terms-and-Conditions.aspx>, and, for electronic format documents, subject to Terms and Conditions for Electronic Documents at http://www.sgs.com/links_e-document.htm. Attention is drawn to the limitation of liability, indemnification and jurisdiction issues printed therein. Any holder of this document is advised that information contained herein reflects the Company's findings at the time of its issuance only and within the limits of C.O.S.T.'s instructions, if any. The Company's sole responsibility is to its Client and this document does not constitute part of a transaction nor is it binding on the Client and obligates under the transaction documents. This document cannot be reproduced except in full, without prior written approval of the Company. Any unauthorized alteration, forgery or falsification of the content or appearance of this document is unlawful and offenders may be prosecuted to the fullest extent of the law. Unless otherwise stated the results shown in this test report refer only to the sample(s) tested and such sample(s) are retained for 90 days only.

F052 Version 5

SGS Korea Co., Ltd.

322, The Ovalley, 555-9, Hoggys-dong, Dongam-gu, Anyang-si, Gyeonggi-do, Korea 431-080
t +82 (0)31 4608 000 f +82 (0)31 4608 059 <http://www.sgsk.co.kr> www.kr.sgs.com/press/eng

Member of the SGS Group (Societ  Generale de Surveillances)

Revision History

Date	No.	Revision History	Writer	
			Drawn	Approved
2012.11.29	001	New version	W.H Jung	M.S Choi
2013.05.14	002	1) Change of tapping Q'ty from 2,000pcs to 2,500pcs 2) Change of CIE tolerance x,y:±0.005	W.H Jung	Y.T KIM