

Transmissive Optical Sensor with Phototransistor Output

Description

This device has a compact construction where the emitting-light sources and the detectors are located face-to-face on the same optical axis. The operating wavelength is 950 nm. The detector consists of a phototransistor.

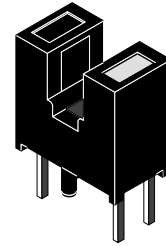

95 10529

Applications

- Position sensor for shaft encoder
- Detection of opaque material such as paper, IBM cards, magnetic tapes etc.
- Limit switch for mechanical motions in VCR
- General purpose – wherever the space is limited
- End of tape, begin of tape in streamer

Features

- Gap 3 mm
- Package height: 8 mm
- Plastic polycarbonate housing
- Ambient light protected
- L = long leads
- **Current Transfer Ratio (CTR)** of typical 25%

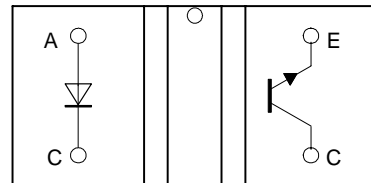

96 11970

Order Instruction

Ordering Code	Resolution (mm) / Aperture (mm)	Remarks
TCST1030	/ non	High density packing leads (3.4 mm)
TCST1030(L)	/ non	High density packing long leads (16.2 mm)

Absolute Maximum Ratings

Input (Emitter)

Parameter	Test Conditions	Symbol	Value	Unit
Reverse voltage		V_R	6	V
Forward current		I_F	60	mA
Forward surge current	$t_p \leq 10 \mu\text{s}$	I_{FSM}	3	A
Power dissipation	$T_{amb} \leq 25^\circ\text{C}$	P_V	100	mW
Junction temperature		T_j	100	$^\circ\text{C}$

Output (Detector)

Parameter	Test Conditions	Symbol	Value	Unit
Collector emitter voltage		V_{CEO}	70	V
Emitter collector voltage		V_{ECO}	7	V
Collector current		I_C	100	mA
Power dissipation	$T_{amb} \leq 25^\circ\text{C}$	P_V	150	mW
Junction temperature		T_j	100	$^\circ\text{C}$

Coupler

Parameter	Test Conditions	Symbol	Value	Unit
Total power dissipation	$T_{amb} \leq 25^\circ\text{C}$	P_{tot}	250	mW
Operation temperature range		T_{amb}	-25 to +85	$^\circ\text{C}$
Storage temperature range		T_{stg}	-25 to +100	$^\circ\text{C}$
Soldering temperature	1.6 mm from case, $t \leq 10 \text{ s}$	T_{sd}	260	$^\circ\text{C}$

Electrical Characteristics ($T_{amb} = 25^\circ\text{C}$)

Input (Emitter)

Parameter	Test Conditions	Symbol	Min.	Typ.	Max.	Unit
Forward voltage	$I_F = 60 \text{ mA}$	V_F		1.25	1.5	V
Junction capacitance	$V_R = 0, f = 1 \text{ MHz}$	C_j		50		pF

Output (Detector)

Parameter	Test Conditions	Symbol	Min.	Typ.	Max.	Unit
Collector emitter voltage	$I_C = 1 \text{ mA}$	V_{CEO}	70			V
Emitter collector voltage	$I_E = 10 \mu\text{A}$	V_{ECO}	7			V
Collector dark current	$V_{CE} = 25 \text{ V}, I_F = 0, E = 0$	I_{CEO}		10	100	nA

Coupler

Parameter	Test Conditions	Symbol	Min.	Typ.	Max.	Unit
Collector current	$V_{CE} = 5 \text{ V}, I_F = 10 \text{ mA}$	I_C	1.2	2.4		mA
Collector emitter saturation voltage	$I_F = 10 \text{ mA}, I_C = 1 \text{ mA}$	V_{CEsat}			0.8	V

Switching Characteristics

Parameter	Test Conditions	Symbol	Typ.	Unit
Turn-on time	$I_C = 1 \text{ mA}$, $V_{CE} = 5 \text{ V}$, $R_L = 100 \Omega$ (see figure 1)	t_{on}	15.0	μs
Turn-off time		t_{off}	10.0	μs

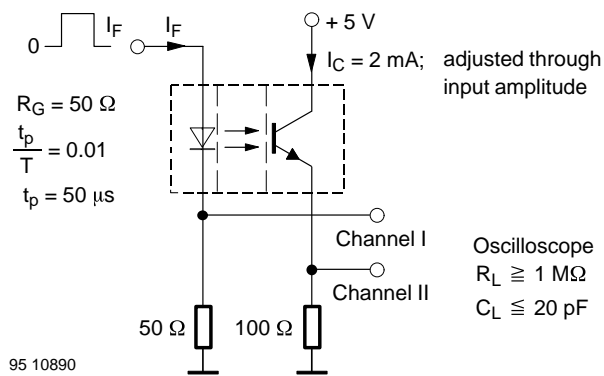

Figure 1. Test circuit

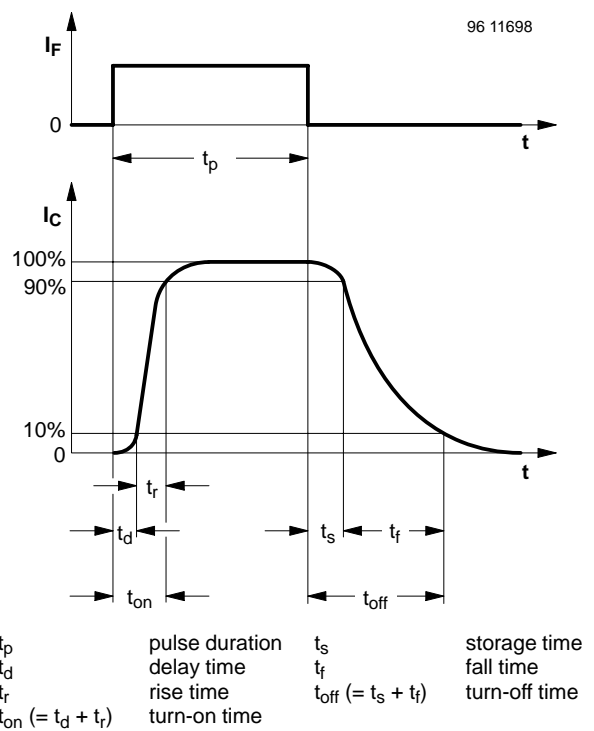

Figure 2. Switching times

Typical Characteristics ($T_{amb} = 25^{\circ}\text{C}$, unless otherwise specified)

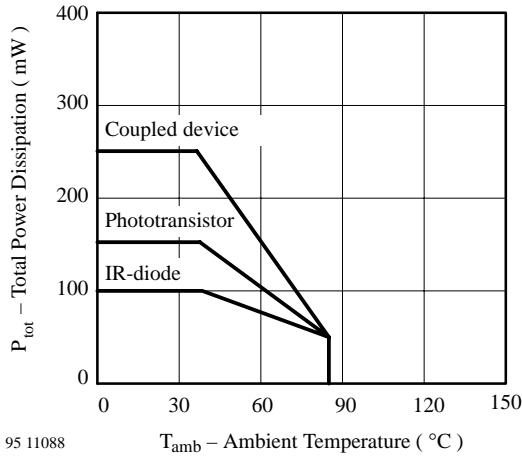

Figure 3. Total Power Dissipation vs. Ambient Temperature

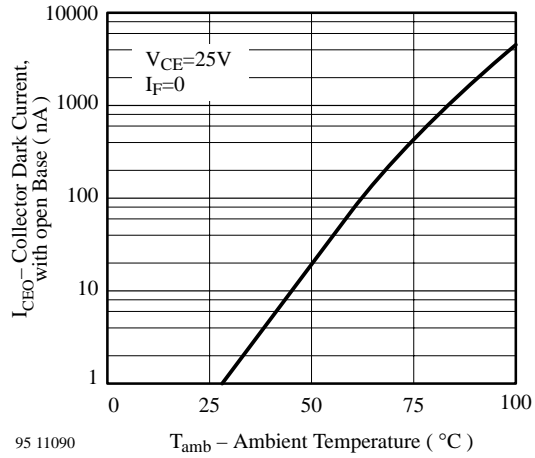

Figure 6. Collector Dark Current vs. Ambient Temperature

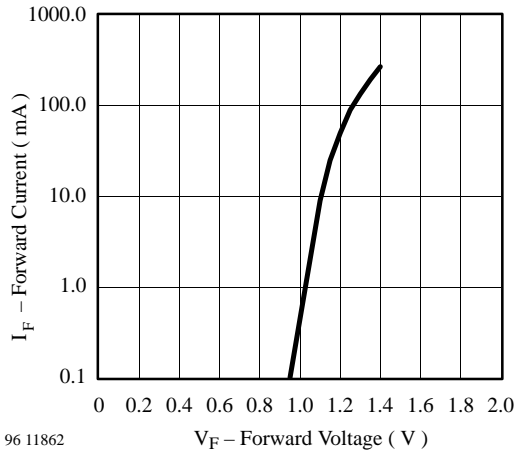

Figure 4. Forward Current vs. Forward Voltage

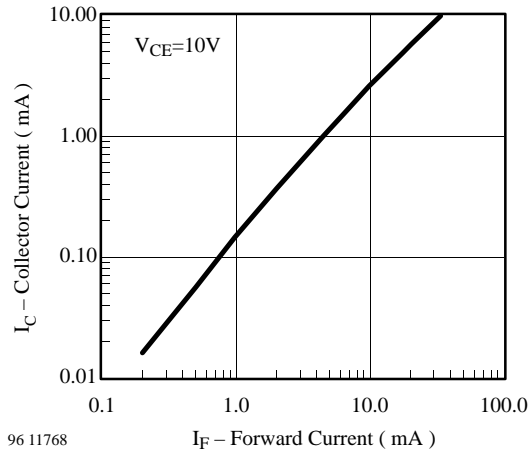

Figure 7. Collector Current vs. Forward Current

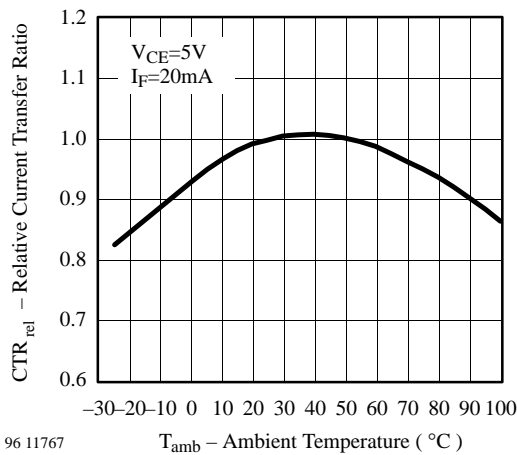

Figure 5. Relative Current Transfer Ratio vs. Ambient Temperature

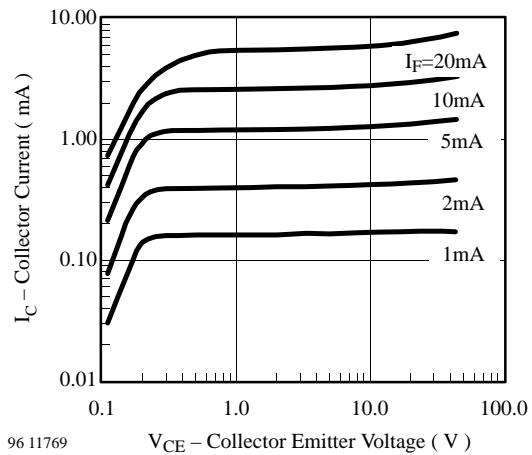

Figure 8. Collector Current vs. Collector Emitter Voltage

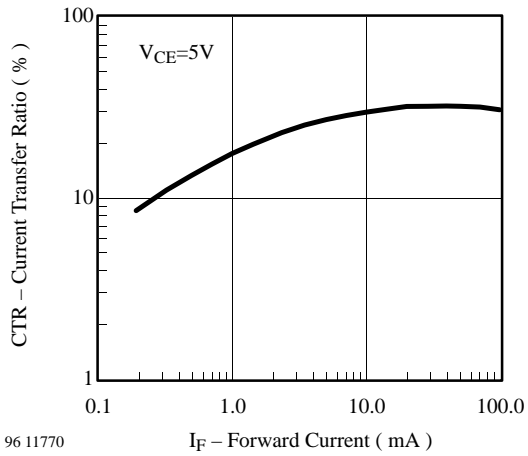

Figure 9. Current Transfer Ratio vs. Forward Current

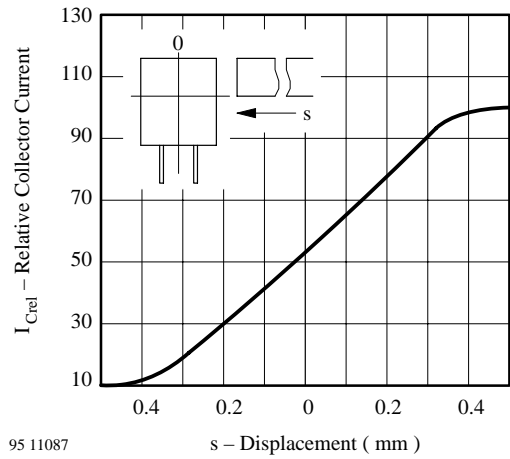

Figure 11. Relative Collector Current vs. Displacement

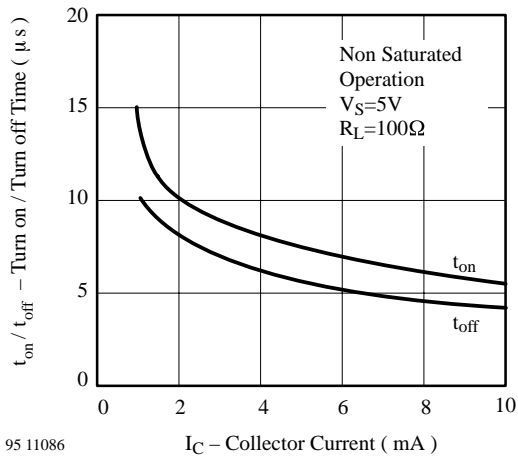

Figure 10. Turn on / off Time vs. Collector Current

TCST1030(L)

Vishay Semiconductors



Dimensions of TCST1030 in mm

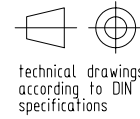
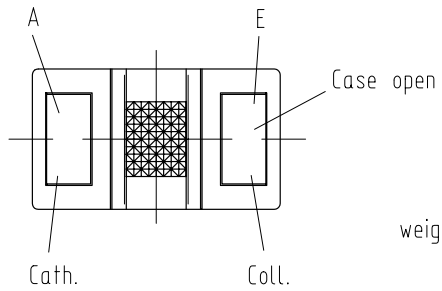
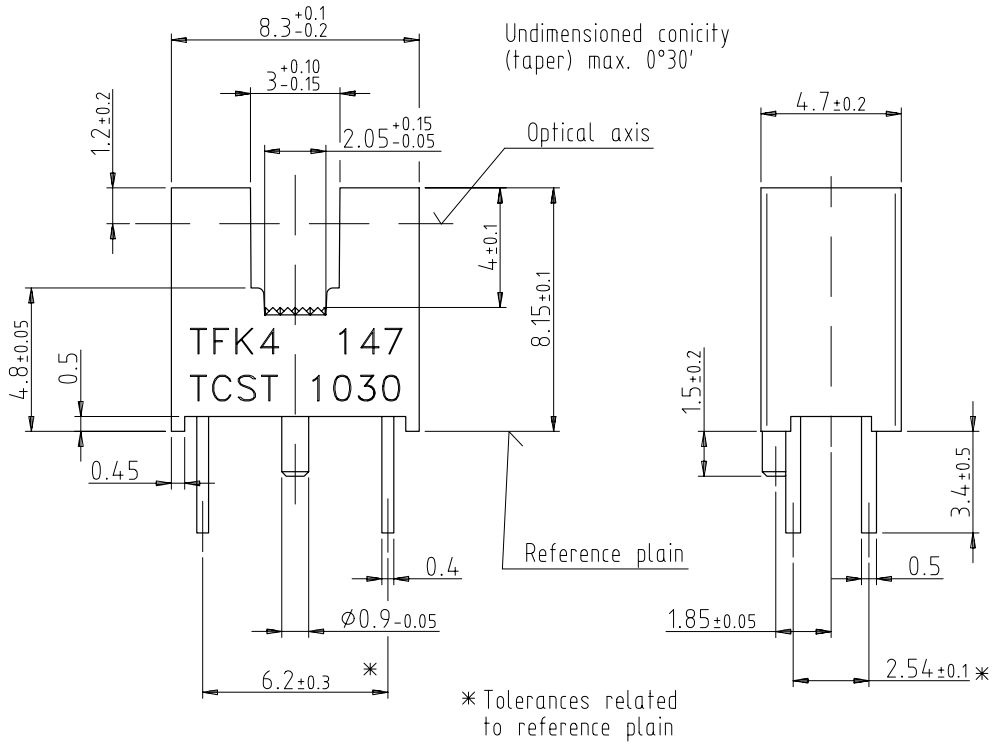

96 12074



Dimensions of TCST1030L in mm

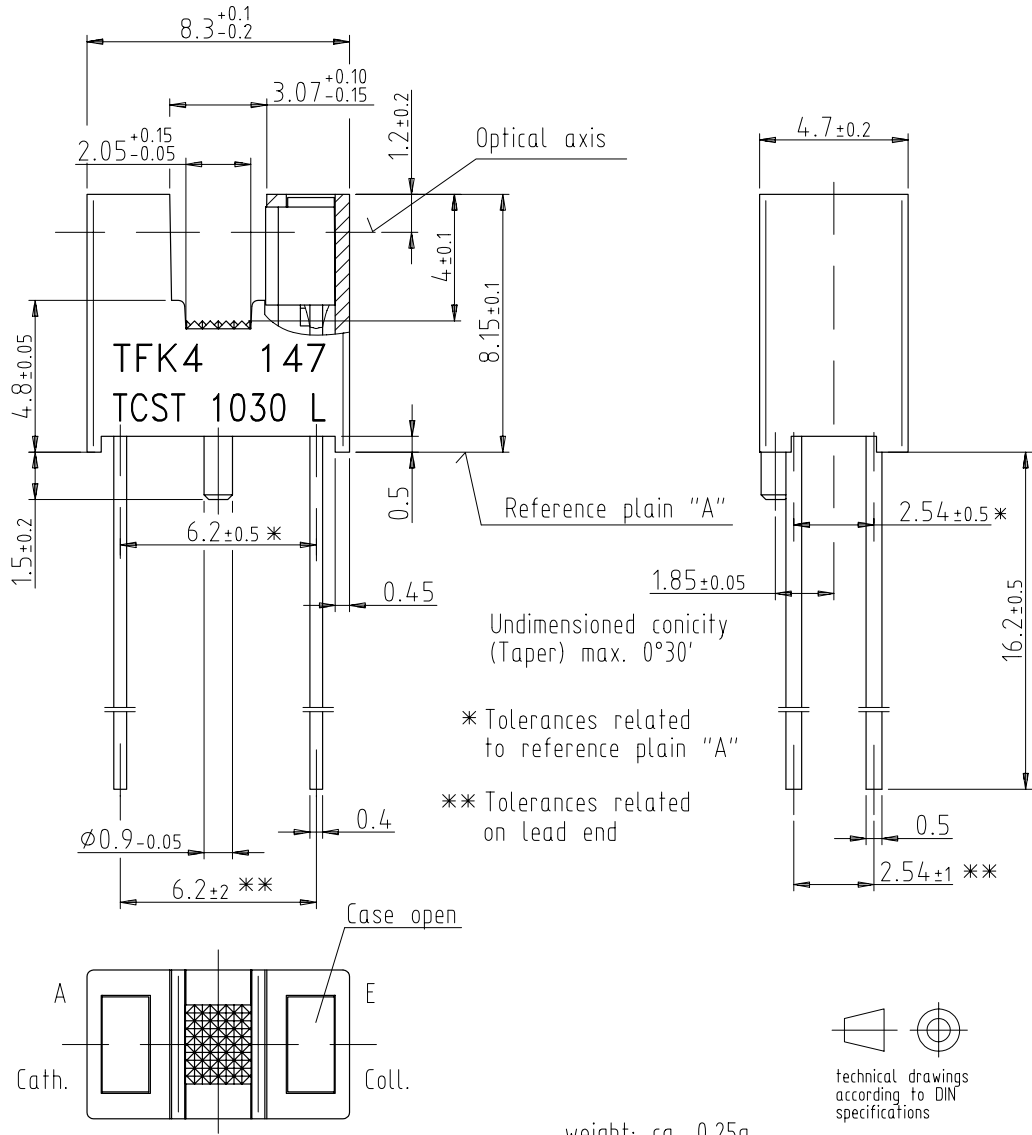

Drawing-No.: 6.550-5147.01-4
 Issue: 2; 10.11.98

95 11268

Ozone Depleting Substances Policy Statement

It is the policy of **Vishay Semiconductor GmbH** to

1. Meet all present and future national and international statutory requirements.
2. Regularly and continuously improve the performance of our products, processes, distribution and operating systems with respect to their impact on the health and safety of our employees and the public, as well as their impact on the environment.

It is particular concern to control or eliminate releases of those substances into the atmosphere which are known as ozone depleting substances (ODSs).

The Montreal Protocol (1987) and its London Amendments (1990) intend to severely restrict the use of ODSs and forbid their use within the next ten years. Various national and international initiatives are pressing for an earlier ban on these substances.

Vishay Semiconductor GmbH has been able to use its policy of continuous improvements to eliminate the use of ODSs listed in the following documents.

1. Annex A, B and list of transitional substances of the Montreal Protocol and the London Amendments respectively
2. Class I and II ozone depleting substances in the Clean Air Act Amendments of 1990 by the Environmental Protection Agency (EPA) in the USA
3. Council Decision 88/540/EEC and 91/690/EEC Annex A, B and C (transitional substances) respectively.

Vishay Semiconductor GmbH can certify that our semiconductors are not manufactured with ozone depleting substances and do not contain such substances.

We reserve the right to make changes to improve technical design and may do so without further notice.

Parameters can vary in different applications. All operating parameters must be validated for each customer application by the customer. Should the buyer use Vishay Semiconductors products for any unintended or unauthorized application, the buyer shall indemnify Vishay Semiconductors against all claims, costs, damages, and expenses, arising out of, directly or indirectly, any claim of personal damage, injury or death associated with such unintended or unauthorized use.

Vishay Semiconductor GmbH, P.O.B. 3535, D-74025 Heilbronn, Germany
Telephone: 49 (0) 7131 67 2831, Fax number: 49 (0) 7131 67 2423