

Low Current LED in \varnothing 3 mm Tinted Diffused Package

| Color | Type | Technology | Angle of Half Intensity $\pm\varphi$ |
|---------------------|----------|--------------|-----------------------------------------|
| High efficiency red | TLLR440. | GaAsP on GaP | 25° |
| Yellow | TLLY440. | GaAsP on GaP | 25° |
| Green | TLLG440. | GaP on GaP | 25° |

94 8488

Features

- Low power consumption
- High brightness
- CMOS/MOS compatible
- Specified at $I_F = 2$ mA
- Luminous intensity categorized
- Yellow and green color categorized

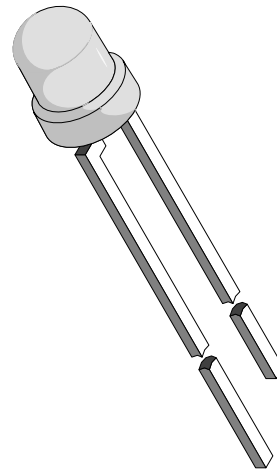

Applications

Low power DC circuits

Absolute Maximum Ratings

$T_{amb} = 25^\circ\text{C}$, unless otherwise specified

TLLR440. , **TLLY440.** , **TLLG440.** ,

| Parameter | Test Conditions | Symbol | Value | Unit |
|-------------------------------------|---------------------------------|------------|-------------|------------------|
| Reverse voltage | | V_R | 6 | V |
| DC forward current | | I_F | 7 | mA |
| Surge forward current | $t_p \leq 10 \mu\text{s}$ | I_{FSM} | 0.15 | A |
| Power dissipation | $T_{amb} \leq 84^\circ\text{C}$ | P_V | 20 | mW |
| Junction temperature | | T_j | 100 | $^\circ\text{C}$ |
| Operating temperature range | | T_{amb} | -40 to +100 | $^\circ\text{C}$ |
| Storage temperature range | | T_{stg} | -55 to +100 | $^\circ\text{C}$ |
| Soldering temperature | $t \leq 5$ s, 2 mm from body | T_{sd} | 260 | $^\circ\text{C}$ |
| Thermal resistance junction/ambient | | R_{thJA} | 800 | K/W |

Optical and Electrical Characteristics

$T_{amb} = 25^{\circ}\text{C}$, unless otherwise specified

High efficiency red (TLLR440.)

| Parameter | Test Conditions | Type | Symbol | Min | Typ | Max | Unit |
|----------------------------------|--------------------------------|----------|-------------|------|----------|-----|------|
| Luminous intensity ¹⁾ | $I_F = 2 \text{ mA}$ | TLLR4400 | I_V | 0.63 | 1.2 | | mcd |
| | | TLLR4401 | I_V | 1 | 2 | | mcd |
| Dominant wavelength | $I_F = 2 \text{ mA}$ | | λ_d | 612 | | 625 | nm |
| Peak wavelength | $I_F = 2 \text{ mA}$ | | λ_p | | 635 | | nm |
| Angle of half intensity | $I_F = 2 \text{ mA}$ | | ϕ | | ± 25 | | deg |
| Forward voltage | $I_F = 2 \text{ mA}$ | | V_F | | 1.9 | 2.4 | V |
| Reverse voltage | $I_R = 10 \text{ }\mu\text{A}$ | | V_R | 6 | 20 | | V |
| Junction capacitance | $V_R = 0, f = 1 \text{ MHz}$ | | C_j | | 50 | | pF |

¹⁾ in one Packing Unit $I_{V\text{Min.}}/I_{V\text{Max.}} \leq 0.5$

Yellow (TLLY440.)

| Parameter | Test Conditions | Type | Symbol | Min | Typ | Max | Unit |
|----------------------------------|--------------------------------|----------|-------------|------|----------|-----|------|
| Luminous intensity ¹⁾ | $I_F = 2 \text{ mA}$ | TLLY4400 | I_V | 0.63 | 1.2 | | mcd |
| | | TLLY4401 | I_V | 1 | 2 | | mcd |
| Dominant wavelength | $I_F = 2 \text{ mA}$ | | λ_d | 581 | | 594 | nm |
| Peak wavelength | $I_F = 2 \text{ mA}$ | | λ_p | | 585 | | nm |
| Angle of half intensity | $I_F = 2 \text{ mA}$ | | ϕ | | ± 25 | | deg |
| Forward voltage | $I_F = 2 \text{ mA}$ | | V_F | | 2.4 | 2.9 | V |
| Reverse voltage | $I_R = 10 \text{ }\mu\text{A}$ | | V_R | 6 | 20 | | V |
| Junction capacitance | $V_R = 0, f = 1 \text{ MHz}$ | | C_j | | 50 | | pF |

¹⁾ in one Packing Unit $I_{V\text{Min.}}/I_{V\text{Max.}} \leq 0.5$

Green (TLLG440.)

| Parameter | Test Conditions | Type | Symbol | Min | Typ | Max | Unit |
|----------------------------------|--------------------------------|----------|-------------|------|----------|-----|------|
| Luminous intensity ¹⁾ | $I_F = 2 \text{ mA}$ | TLLG4400 | I_V | 0.63 | 1.2 | | mcd |
| | | TLLG4401 | I_V | 1 | 2 | | mcd |
| Dominant wavelength | $I_F = 2 \text{ mA}$ | | λ_d | 562 | | 575 | nm |
| Peak wavelength | $I_F = 2 \text{ mA}$ | | λ_p | | 565 | | nm |
| Angle of half intensity | $I_F = 2 \text{ mA}$ | | ϕ | | ± 25 | | deg |
| Forward voltage | $I_F = 2 \text{ mA}$ | | V_F | | 1.9 | 2.4 | V |
| Reverse voltage | $I_R = 10 \text{ }\mu\text{A}$ | | V_R | 6 | 20 | | V |
| Junction capacitance | $V_R = 0, f = 1 \text{ MHz}$ | | C_j | | 50 | | pF |

¹⁾ in one Packing Unit $I_{V\text{Min.}}/I_{V\text{Max.}} \leq 0.5$

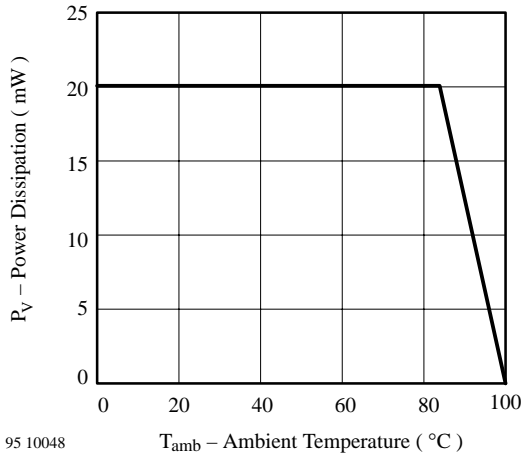
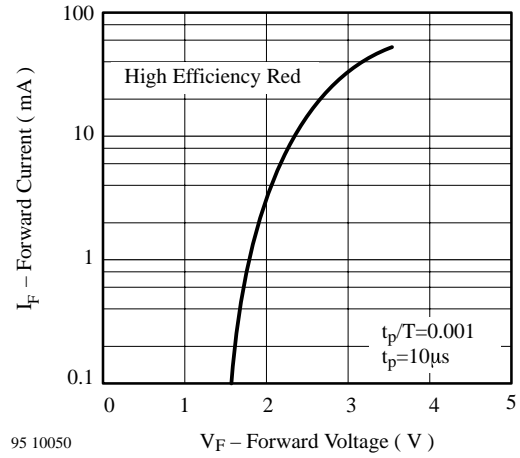
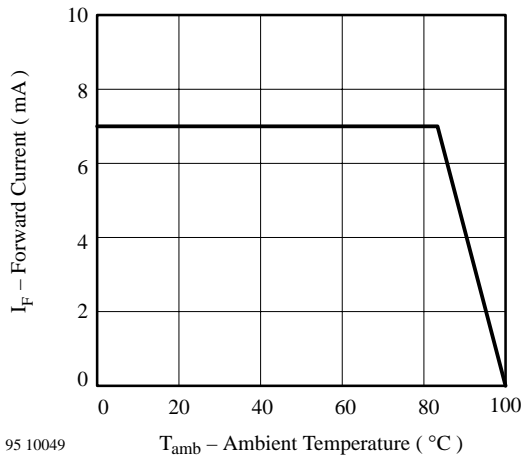
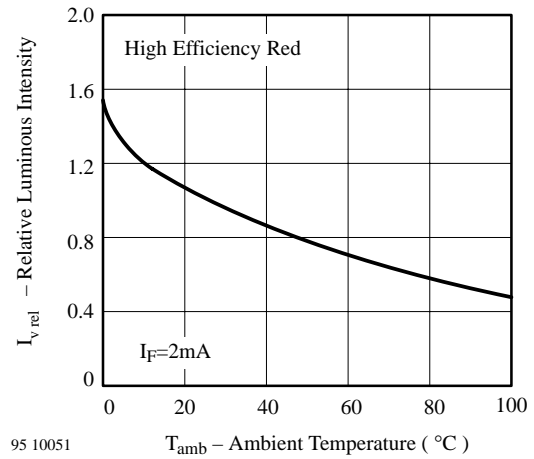
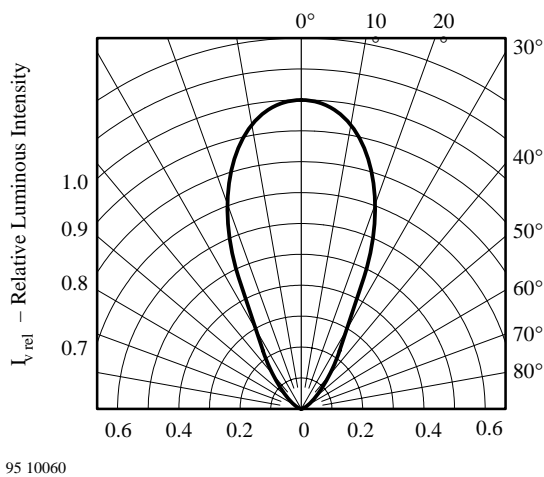
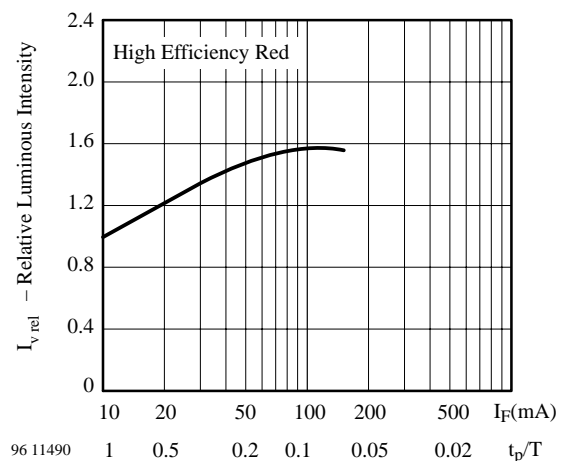
Typical Characteristics ($T_{amb} = 25^{\circ}\text{C}$, unless otherwise specified)

Figure 1. Power Dissipation vs. Ambient Temperature

Figure 4. Forward Current vs. Forward Voltage

Figure 2. Forward Current vs. Ambient Temperature

Figure 5. Rel. Luminous Intensity vs. Ambient Temperature

Figure 3. Rel. Luminous Intensity vs. Angular Displacement

Figure 6. Rel. Lumin. Intensity vs. Forw. Current/Duty Cycle

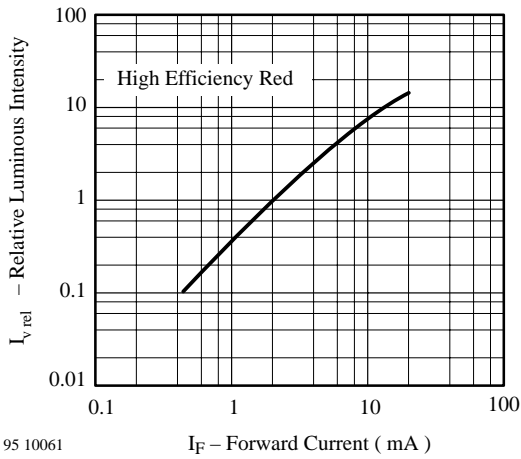

Figure 7. Relative Luminous Intensity vs. Forward Current

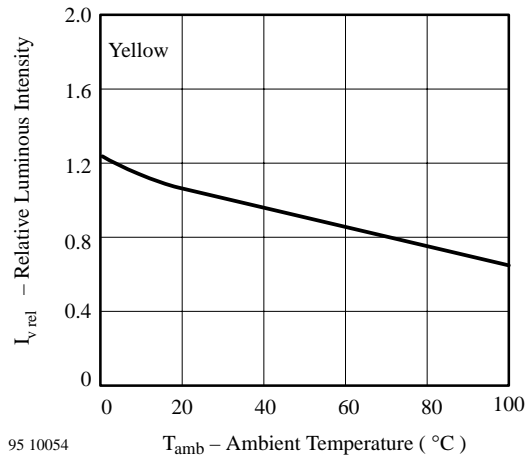

Figure 10. Rel. Luminous Intensity vs. Ambient Temperature

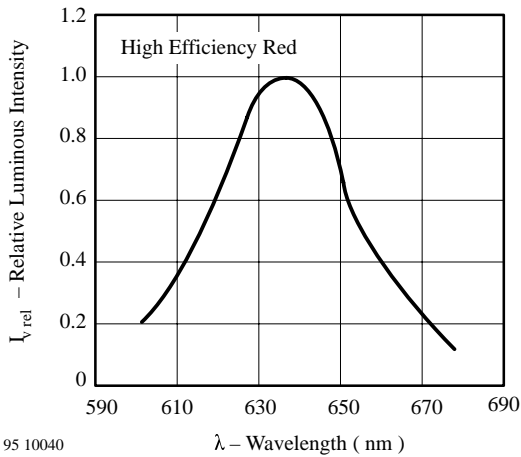

Figure 8. Relative Luminous Intensity vs. Wavelength

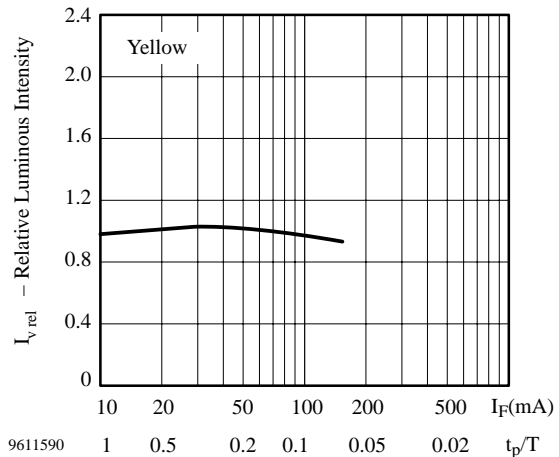

Figure 11. Rel. Lumin. Intensity vs. Forw. Current/Duty Cycle

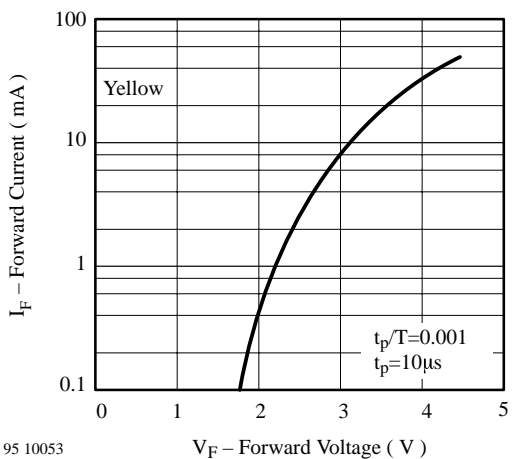

Figure 9. Forward Current vs. Forward Voltage

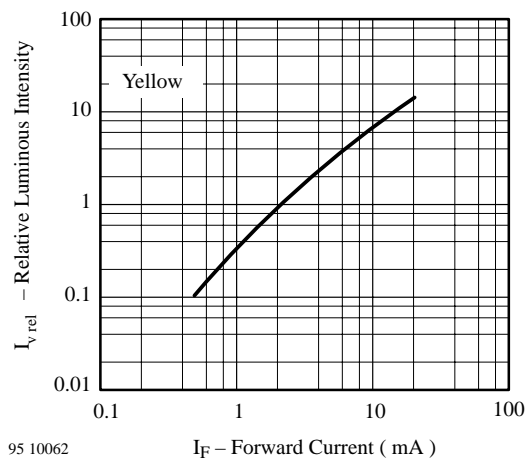

Figure 12. Relative Luminous Intensity vs. Forward Current

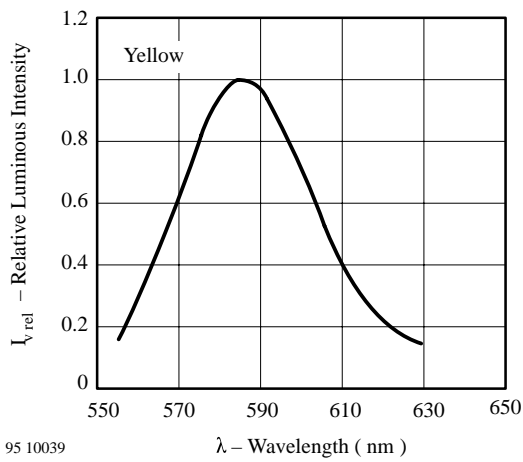

Figure 13. Relative Luminous Intensity vs. Wavelength

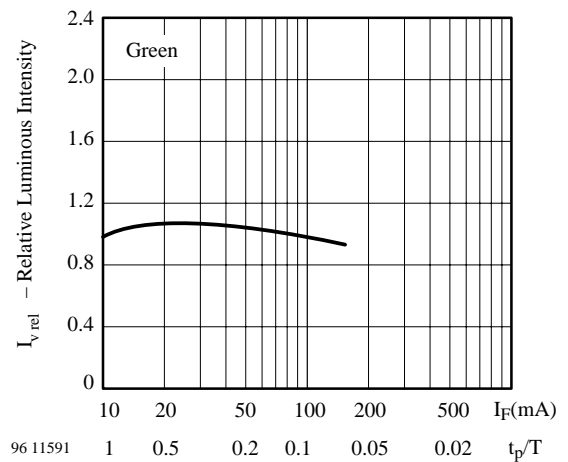

Figure 16. Rel. Lumin. Intensity vs. Forw. Current/Duty Cycle

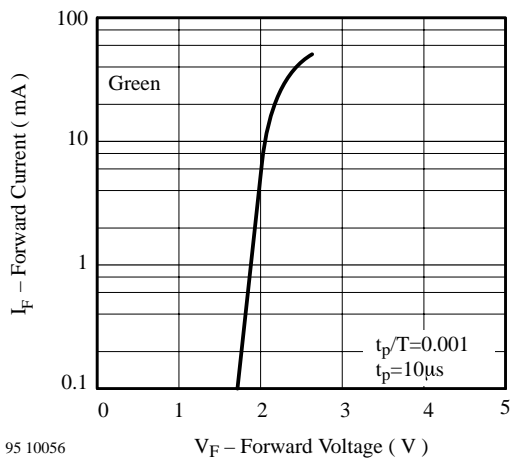

Figure 14. Forward Current vs. Forward Voltage

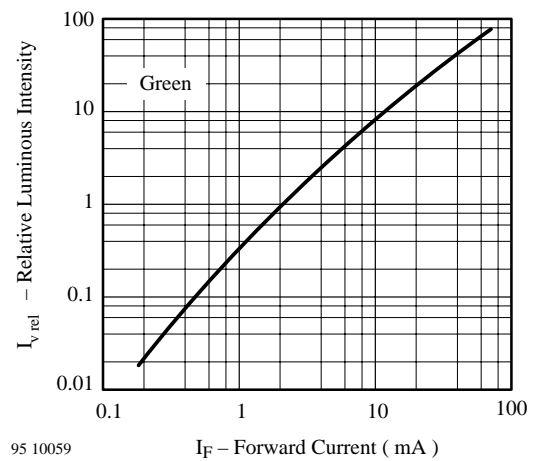

Figure 17. Relative Luminous Intensity vs. Forward Current

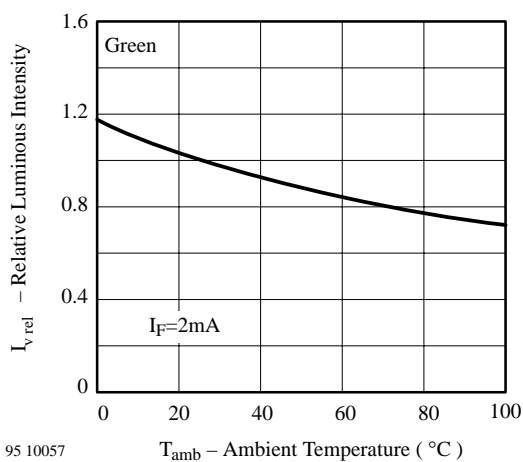

Figure 15. Rel. Luminous. Intensity vs. Ambient Temperature

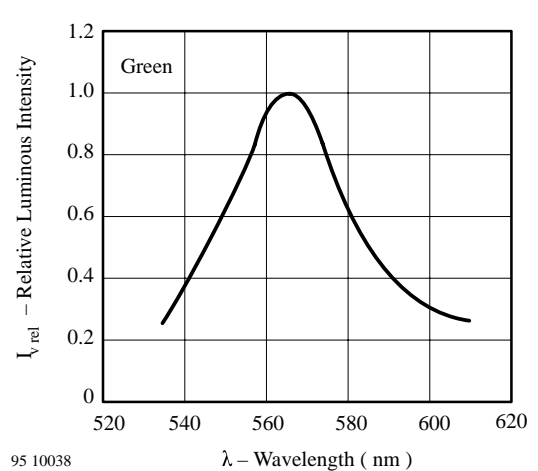
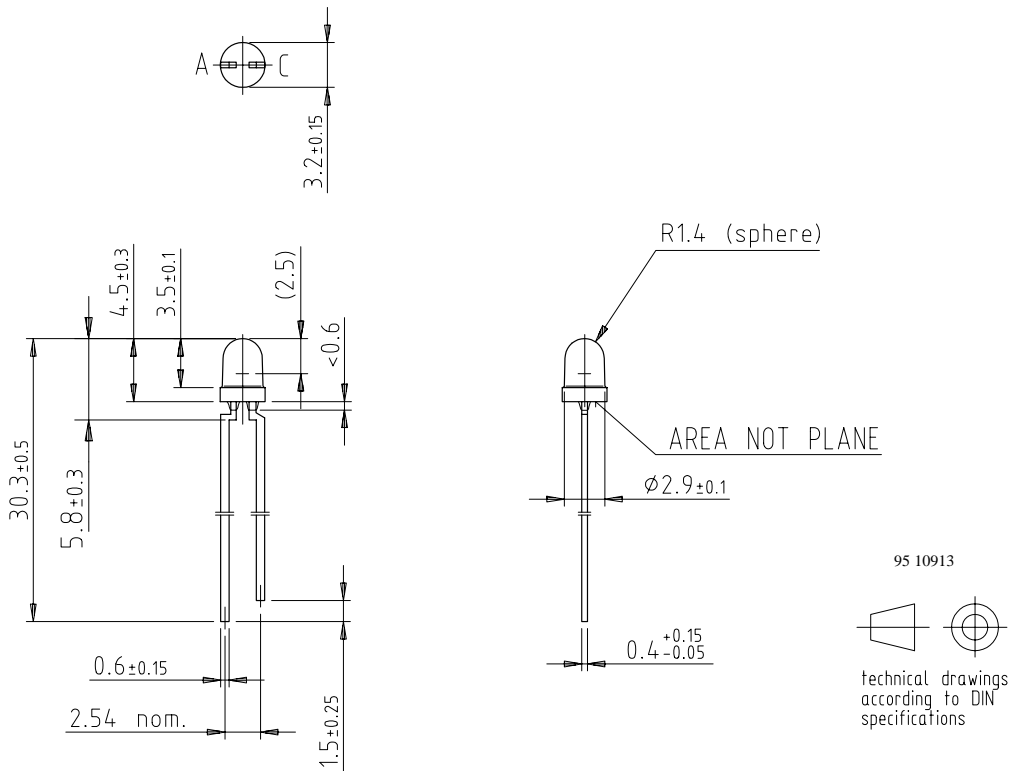

Figure 18. Relative Luminous Intensity vs. Wavelength

Dimensions in mm





Ozone Depleting Substances Policy Statement

It is the policy of **Vishay Semiconductor GmbH** to

1. Meet all present and future national and international statutory requirements.
2. Regularly and continuously improve the performance of our products, processes, distribution and operating systems with respect to their impact on the health and safety of our employees and the public, as well as their impact on the environment.

It is particular concern to control or eliminate releases of those substances into the atmosphere which are known as ozone depleting substances (ODSs).

The Montreal Protocol (1987) and its London Amendments (1990) intend to severely restrict the use of ODSs and forbid their use within the next ten years. Various national and international initiatives are pressing for an earlier ban on these substances.

Vishay Semiconductor GmbH has been able to use its policy of continuous improvements to eliminate the use of ODSs listed in the following documents.

1. Annex A, B and list of transitional substances of the Montreal Protocol and the London Amendments respectively
2. Class I and II ozone depleting substances in the Clean Air Act Amendments of 1990 by the Environmental Protection Agency (EPA) in the USA
3. Council Decision 88/540/EEC and 91/690/EEC Annex A, B and C (transitional substances) respectively.

Vishay Semiconductor GmbH can certify that our semiconductors are not manufactured with ozone depleting substances and do not contain such substances.

We reserve the right to make changes to improve technical design and may do so without further notice.

Parameters can vary in different applications. All operating parameters must be validated for each customer application by the customer. Should the buyer use Vishay Semiconductors products for any unintended or unauthorized application, the buyer shall indemnify Vishay Semiconductors against all claims, costs, damages, and expenses, arising out of, directly or indirectly, any claim of personal damage, injury or death associated with such unintended or unauthorized use.

Vishay Semiconductor GmbH, P.O.B. 3535, D-74025 Heilbronn, Germany
Telephone: 49 (0)7131 67 2831, Fax number: 49 (0)7131 67 2423