

SMD LED in P-LCC-2 Package

Color	Type	Technology	Angle of Half Intensity $\pm\varphi$
High efficiency red	TLMH310.	GaAsP on GaP	60°
Soft orange	TLMO310.	GaAsP on GaP	60°
Yellow	TLMY310.	GaAsP on GaP	60°
Green	TLMG310.	GaP on GaP	60°
Pure green	TLMP310.	GaP on GaP	60°

Description

These devices have been designed to meet the increasing demand for surface mounting technology. The package of the TLM.310. is the P-LCC-2 (equivalent to a size B tantalum capacitor). It consists of a lead frame which is embedded in a white thermoplast. The reflector inside this package is filled up with clear epoxy.

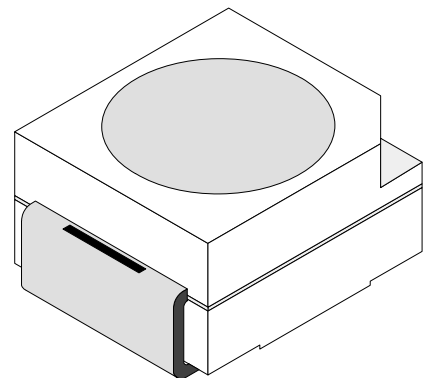

94 8553

Features

- SMD LEDs with exceptional brightness
- Luminous intensity categorized
- Compatible with automatic placement equipment
- EIA and ICE standard package
- Compatible with infrared, vapor phase and wave solder processes according to CECC
- Available in 8 mm tape
- Low profile package
- Non-diffused lens: excellent for coupling to light pipes and backlighting
- Low power consumption
- Luminous intensity ratio in one packaging unit
 $I_{Vmax}/I_{Vmin} \leq 2.0$, optional ≤ 1.6

Applications

Automotive: backlighting in dashboards and switches
 Telecommunication: indicator and backlighting in telephone and fax
 Indicator and backlight for audio and video equipment
 Indicator and backlight in office equipment
 Flat backlight for LCDs, switches and symbols
 General use

Absolute Maximum Ratings

$T_{amb} = 25^{\circ}\text{C}$, unless otherwise specified

TLMH310. , TLMO310. , TLMY310. , TLMG310. , TLMP310.

Parameter	Test Conditions	Symbol	Value	Unit
Reverse voltage		V_R	6	V
DC forward current	$T_{amb} \leq 60^{\circ}\text{C}$	I_F	30	mA
Surge forward current	$t_p \leq 10 \mu\text{s}$	I_{FSM}	0.5	A
Power dissipation	$T_{amb} \leq 60^{\circ}\text{C}$	P_V	100	mW
Junction temperature		T_j	100	$^{\circ}\text{C}$
Operating temperature range		T_{amb}	-40 to +100	$^{\circ}\text{C}$
Storage temperature range		T_{stg}	-55 to +100	$^{\circ}\text{C}$
Soldering temperature	$t \leq 5 \text{ s}$	T_{sd}	260	$^{\circ}\text{C}$
Thermal resistance junction/ambient	mounted on PC board (pad size > 16 mm ²)	R_{thJA}	400	K/W

Optical and Electrical Characteristics

$T_{amb} = 25^{\circ}\text{C}$, unless otherwise specified

High efficiency red (TLMH310.)

Parameter	Test Conditions	Type	Symbol	Min	Typ	Max	Unit
Luminous intensity ²⁾	$I_F = 10 \text{ mA}$	TLMH3100	I_V	2.5	6		mcd
		TLMH3101	I_V	4		12.5	mcd
		TLMH3102	I_V	6.3		20	mcd
Dominant wavelength	$I_F = 10 \text{ mA}$		λ_d	612		625	nm
Peak wavelength	$I_F = 10 \text{ mA}$		λ_p		635		nm
Angle of half intensity	$I_F = 10 \text{ mA}$		ϕ		± 60		deg
Forward voltage	$I_F = 20 \text{ mA}$		V_F		2.4	3	V
Reverse voltage	$I_R = 10 \mu\text{A}$		V_R	6	15		V
Junction capacitance	$V_R = 0, f = 1 \text{ MHz}$		C_j		15		pF

²⁾ in one Packing Unit $I_{VMin.} / I_{VMax.} \leq 2$

Soft orange (TLMO310.)

Parameter	Test Conditions	Type	Symbol	Min	Typ	Max	Unit
Luminous intensity ²⁾	$I_F = 10 \text{ mA}$	TLMO3100	I_V	2.5	8		mcd
		TLMO3101	I_V	4		12.5	mcd
Dominant wavelength	$I_F = 10 \text{ mA}$		λ_d	598		611	nm
Peak wavelength	$I_F = 10 \text{ mA}$		λ_p		605		nm
Angle of half intensity	$I_F = 10 \text{ mA}$		ϕ		± 60		deg
Forward voltage	$I_F = 20 \text{ mA}$		V_F		2.2	3	V
Reverse voltage	$I_R = 10 \mu\text{A}$		V_R	6	15		V
Junction capacitance	$V_R = 0, f = 1 \text{ MHz}$		C_j		15		pF

²⁾ in one Packing Unit $I_{VMin.} / I_{VMax.} \leq 2$



Yellow (TLMY310.)

Parameter	Test Conditions	Type	Symbol	Min	Typ	Max	Unit
Luminous intensity ²⁾	$I_F = 10 \text{ mA}$	TLMY3100	I_V	2.5	6		mcd
Luminous intensity ¹⁾		TLMY3101	I_V	4		12.5	mcd
		TLMY3102	I_V	6.3		20	mcd
Dominant wavelength	$I_F = 10 \text{ mA}$		λ_d	581		594	nm
Peak wavelength	$I_F = 10 \text{ mA}$		λ_p		585		nm
Angle of half intensity	$I_F = 10 \text{ mA}$		ϕ		± 60		deg
Forward voltage	$I_F = 20 \text{ mA}$		V_F		2.4	3	V
Reverse voltage	$I_R = 10 \text{ }\mu\text{A}$		V_R	6	15		V
Junction capacitance	$V_R = 0, f = 1 \text{ MHz}$		C_j		15		pF

¹⁾ in one Packing Unit $I_{V\text{Min.}}/I_{V\text{Max.}} \leq 1.6$ ²⁾ in one Packing Unit $I_{V\text{Min.}}/I_{V\text{Max.}} \leq 2$

Green (TLMG310.)

Parameter	Test Conditions	Type	Symbol	Min	Typ	Max	Unit
Luminous intensity ²⁾	$I_F = 10 \text{ mA}$	TLMG3100	I_V	4	9		mcd
		TLMG3101	I_V	4		12.5	mcd
		TLMG3102	I_V	10		20	mcd
		TLMG3105	I_V	6.3		20	mcd
		TLMG3106	I_V	6.3		12.5	mcd
Dominant wavelength	$I_F = 10 \text{ mA}$		λ_d	562		575	nm
Peak wavelength	$I_F = 10 \text{ mA}$		λ_p		565		nm
Angle of half intensity	$I_F = 10 \text{ mA}$		ϕ		± 60		deg
Forward voltage	$I_F = 20 \text{ mA}$		V_F		2.2	3	V
Reverse voltage	$I_R = 10 \text{ }\mu\text{A}$		V_R	6	15		V
Junction capacitance	$V_R = 0, f = 1 \text{ MHz}$		C_j		15		pF

²⁾ in one Packing Unit $I_{V\text{Min.}}/I_{V\text{Max.}} \leq 2$

Pure green (TLMP310.)

Parameter	Test Conditions	Type	Symbol	Min	Typ	Max	Unit
Luminous intensity ²⁾	$I_F = 10 \text{ mA}$	TLMP3100	I_V	1	4		mcd
		TLMP3101	I_V	1.6		5	mcd
		TLMP3106	I_V	1.6		3.2	mcd
		TLMP3107	I_V	2.5		5	mcd
Luminous intensity ¹⁾		TLMP3102	I_V	2.5		8	mcd
Dominant wavelength	$I_F = 10 \text{ mA}$		λ_d	555		565	nm
Peak wavelength	$I_F = 10 \text{ mA}$		λ_p		555		nm
Angle of half intensity	$I_F = 10 \text{ mA}$		ϕ		± 60		deg
Forward voltage	$I_F = 20 \text{ mA}$		V_F		2.4	3	V
Reverse voltage	$I_R = 10 \text{ }\mu\text{A}$		V_R	6	15		V
Junction capacitance	$V_R = 0, f = 1 \text{ MHz}$		C_j		15		pF

¹⁾ in one Packing Unit $I_{V\text{Min.}}/I_{V\text{Max.}} \leq 1.6$ ²⁾ in one Packing Unit $I_{V\text{Min.}}/I_{V\text{Max.}} \leq 2$

Typical Characteristics ($T_{amb} = 25^{\circ}\text{C}$, unless otherwise specified)

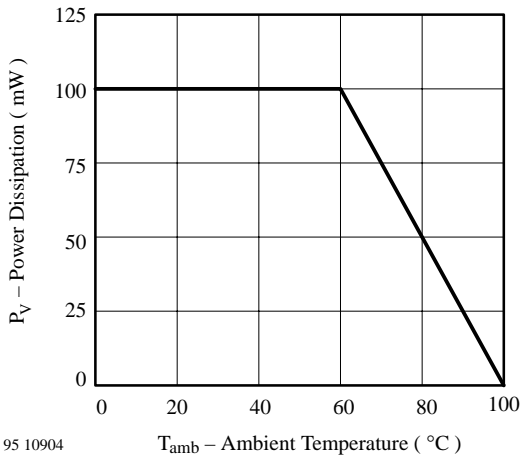

Figure 1. Power Dissipation vs. Ambient Temperature

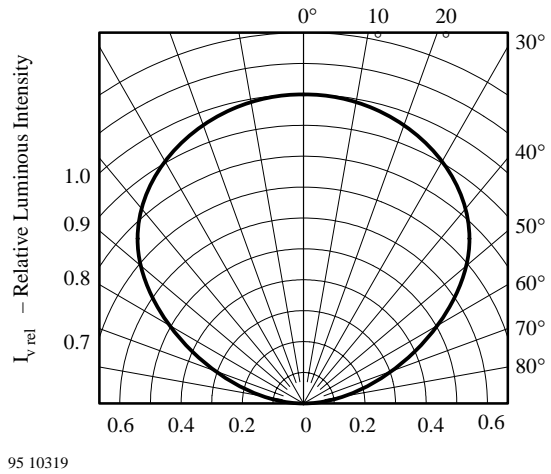

Figure 4. Rel. Luminous Intensity vs. Angular Displacement

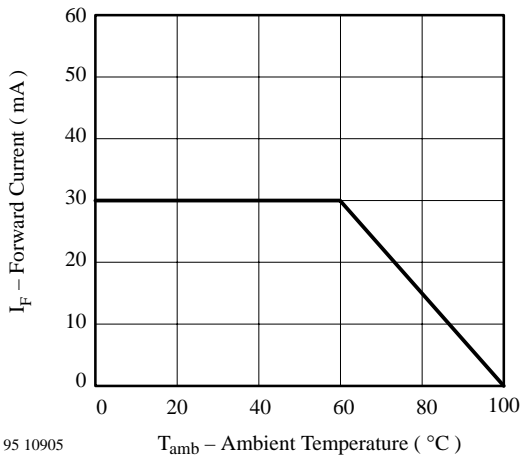

Figure 2. Forward Current vs. Ambient Temperature

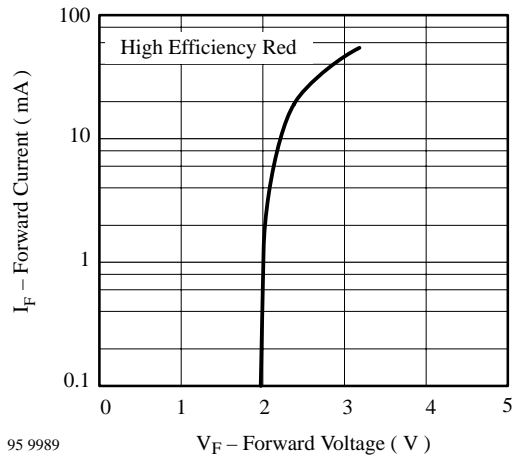

Figure 5. Forward Current vs. Forward Voltage

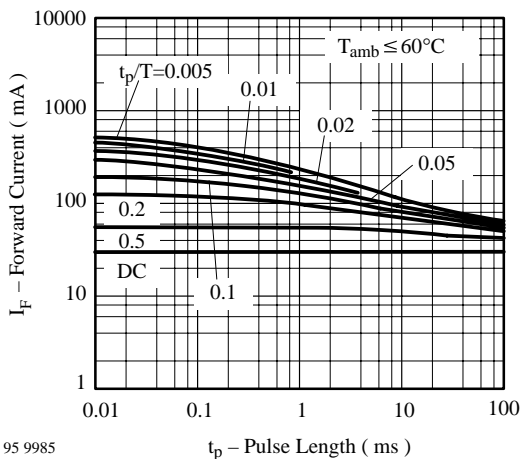

Figure 3. Forward Current vs. Pulse Length

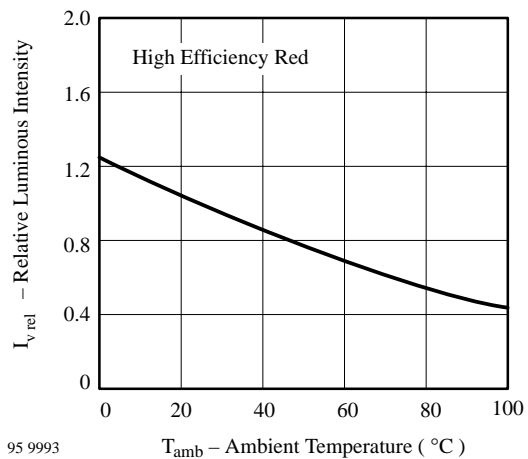

Figure 6. Rel. Luminous Intensity vs. Ambient Temperature

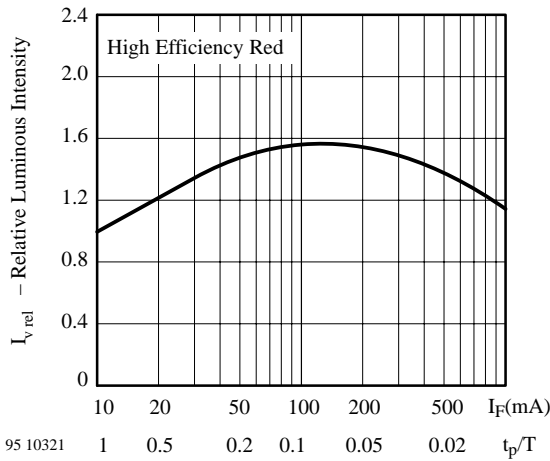

Figure 7. Rel. Lumin. Intensity vs. Forw. Current/Duty Cycle

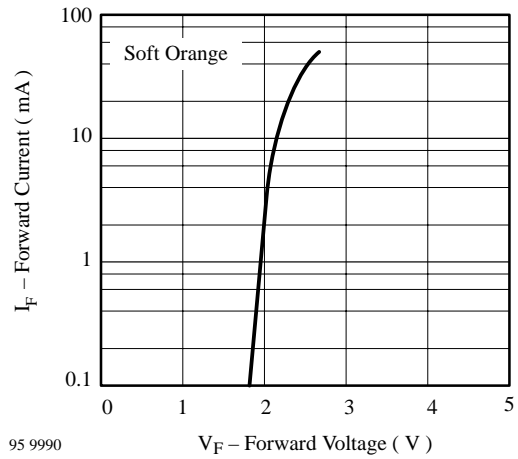

Figure 10. Forward Current vs. Forward Voltage

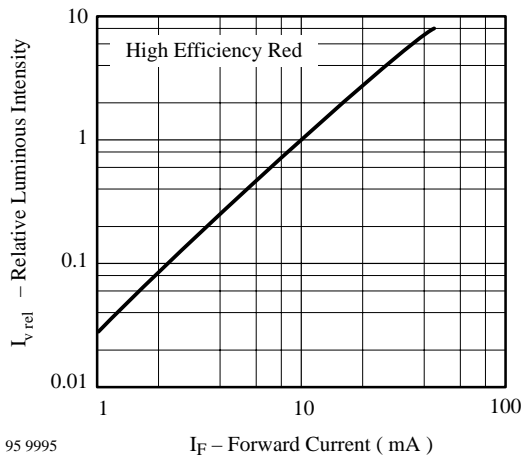

Figure 8. Relative Luminous Intensity vs. Forward Current

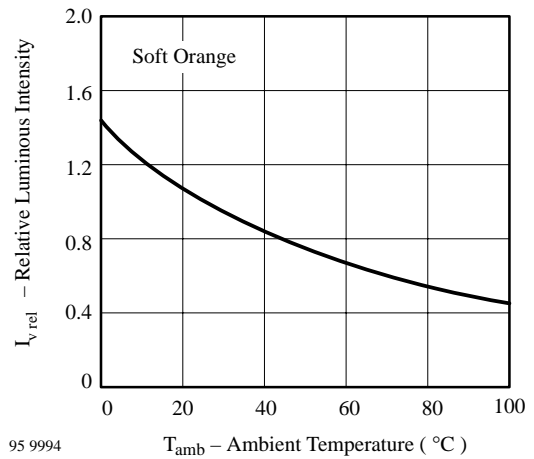

Figure 11. Rel. Luminous Intensity vs. Ambient Temperature

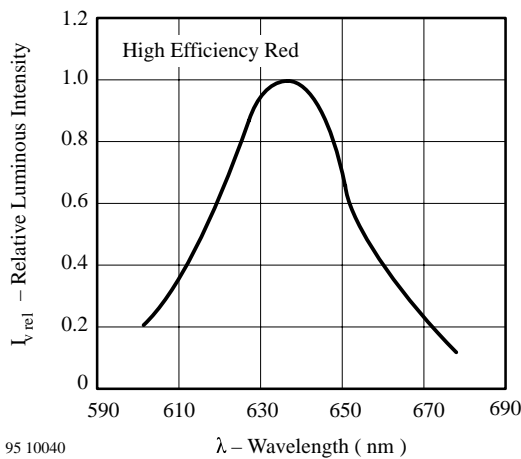

Figure 9. Relative Luminous Intensity vs. Wavelength

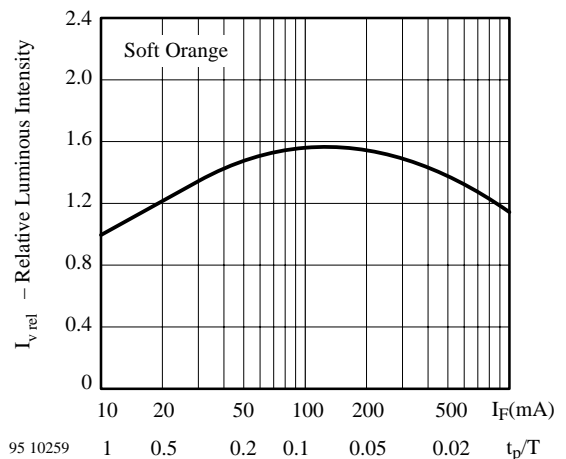

Figure 12. Rel. Lumin. Intensity vs. Forw. Current/Duty Cycle

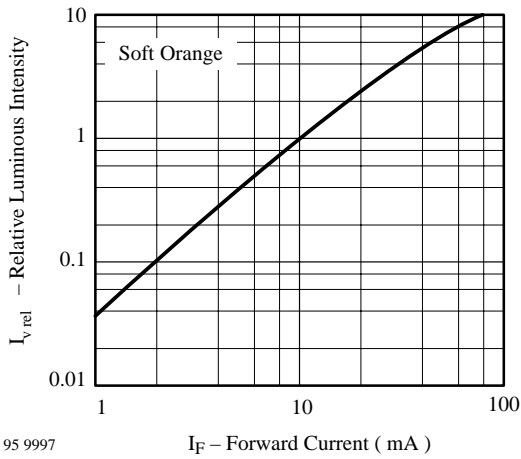

Figure 13. Relative Luminous Intensity vs. Forward Current

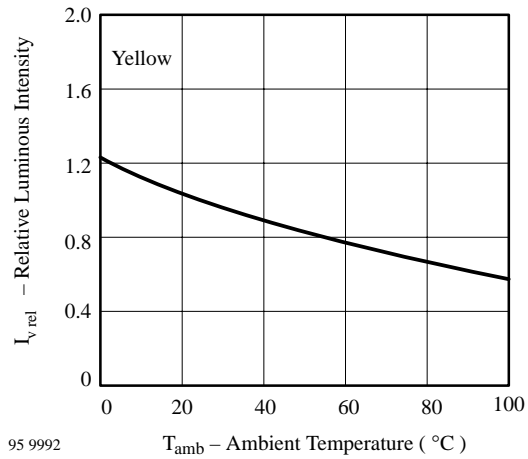

Figure 16. Rel. Luminous Intensity vs. Ambient Temperature

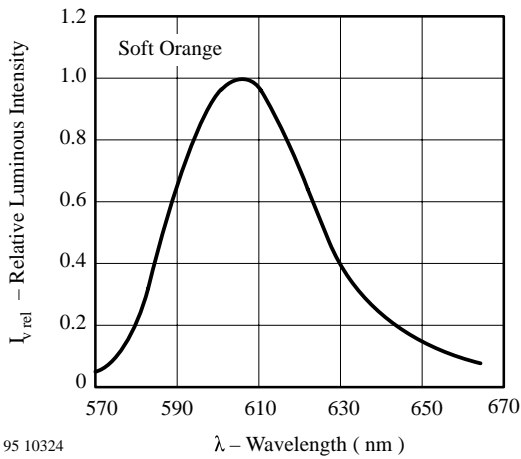

Figure 14. Relative Luminous Intensity vs. Wavelength

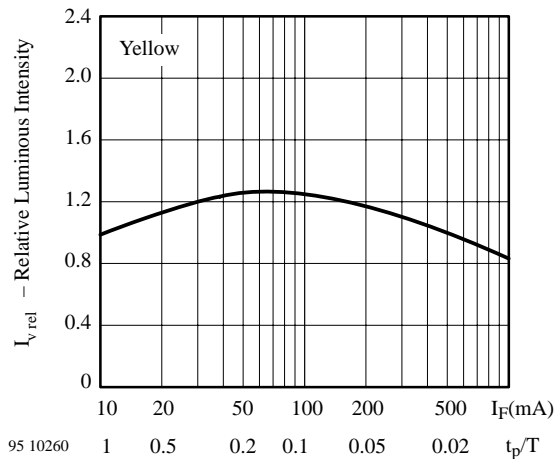

Figure 17. Rel. Lumin. Intensity vs. Forw. Current/Duty Cycle

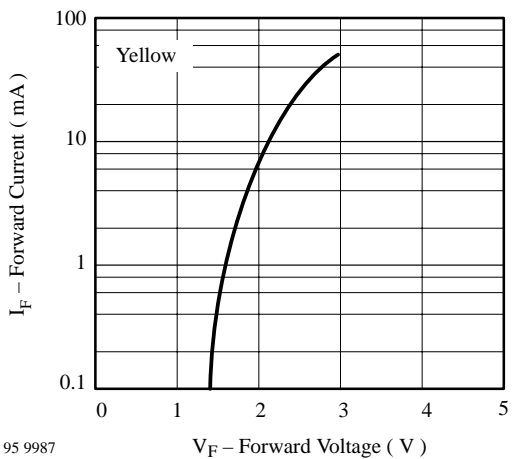

Figure 15. Rel. Luminous Intensity vs. Ambient Temperature

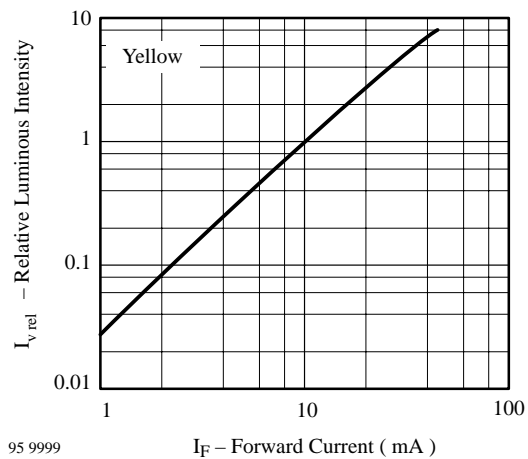
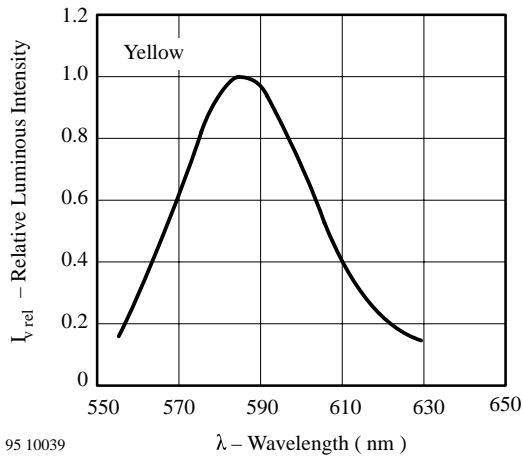
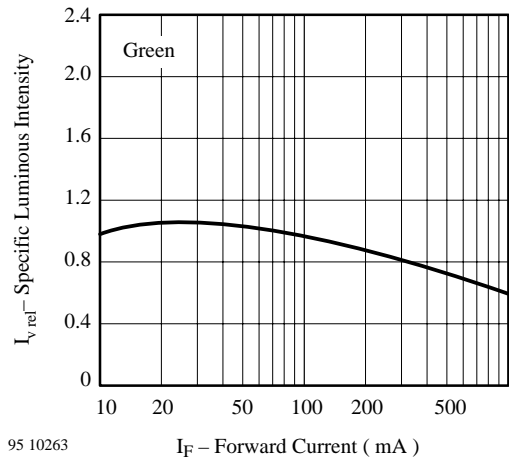

Figure 18. Relative Luminous Intensity vs. Forward Current



95 10039

Figure 19. Relative Luminous Intensity vs. Wavelength



95 10263

Figure 22. Specific Luminous Intensity vs. Forward Current

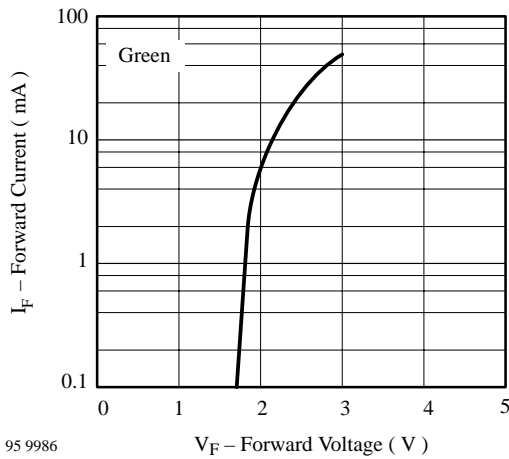

95 9986

Figure 20. Forward Current vs. Forward Voltage

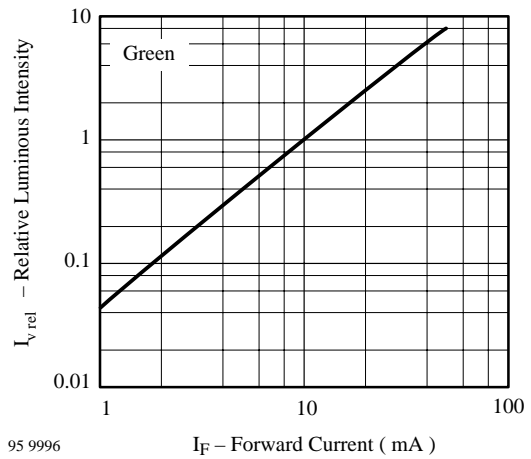

95 9996

Figure 23. Relative Luminous Intensity vs. Forward Current

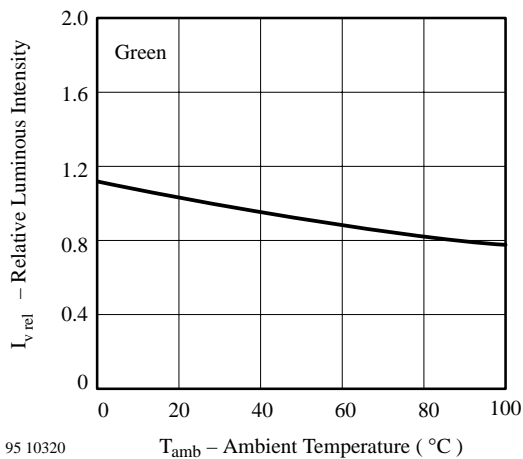

95 10320

Figure 21. Rel. Luminous Intensity vs. Ambient Temperature

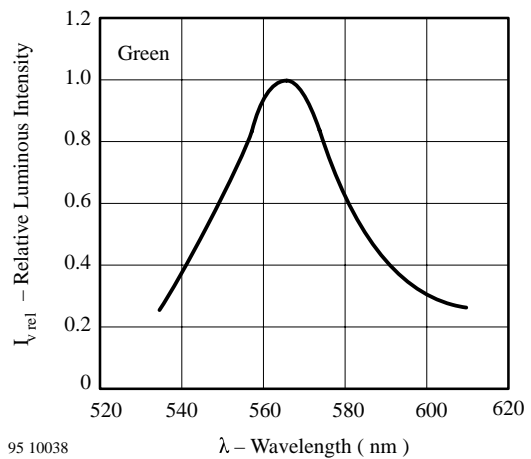

95 10038

Figure 24. Relative Luminous Intensity vs. Wavelength

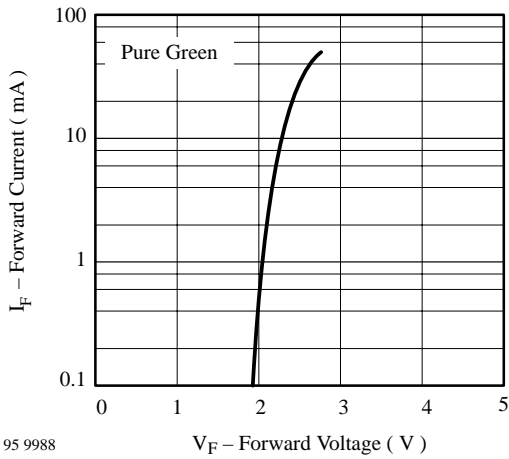

95 9988

Figure 25. Forward Current vs. Forward Voltage

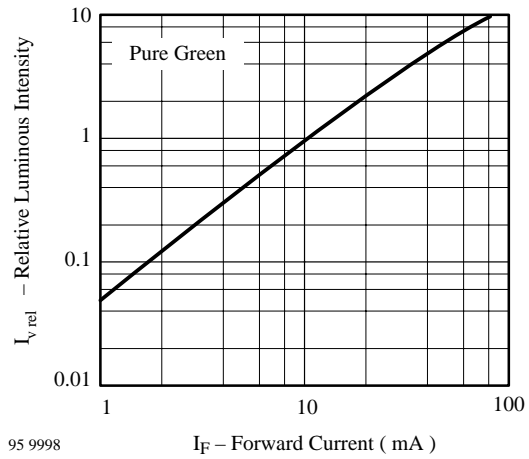

95 9998

Figure 28. Relative Luminous Intensity vs. Forward Current

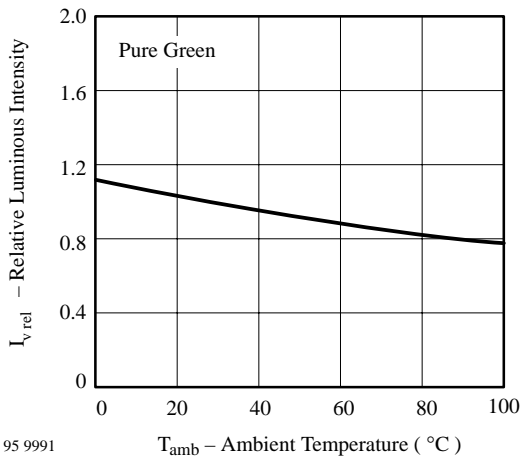

95 9991

Figure 26. Rel. Luminous Intensity vs. Ambient Temperature

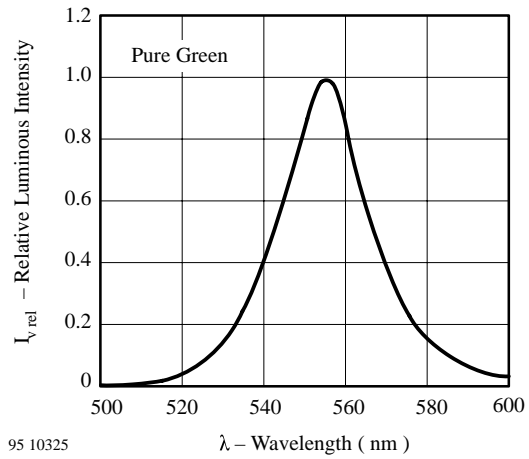

95 10325

Figure 29. Relative Luminous Intensity vs. Wavelength

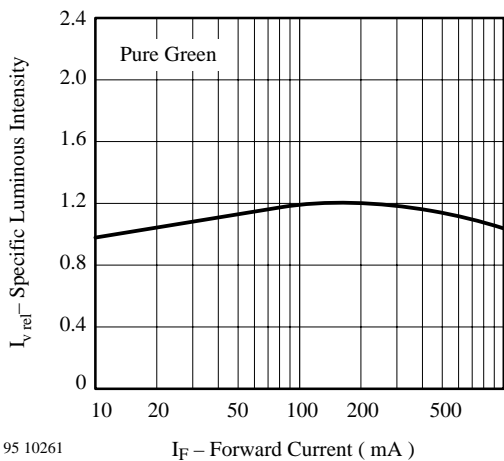

95 10261

Figure 27. Specific Luminous Intensity vs. Forward Current

Dimensions in mm

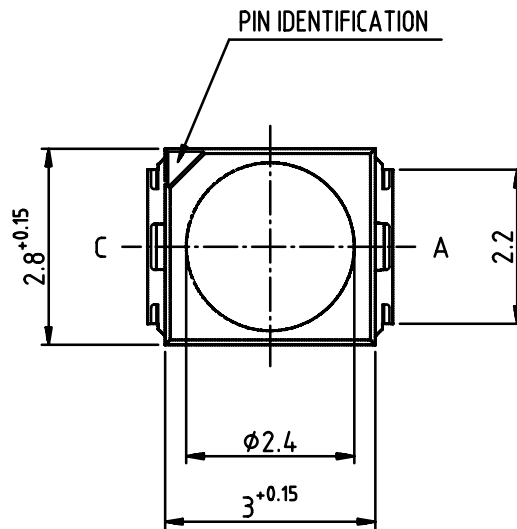
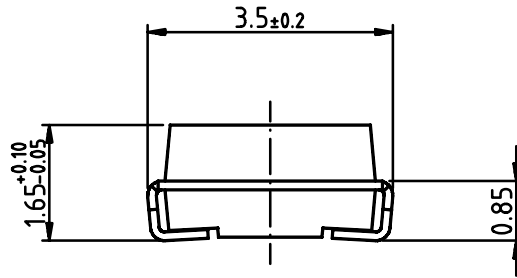

95 11314

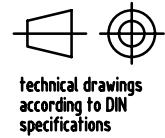

PCB Layout in mm

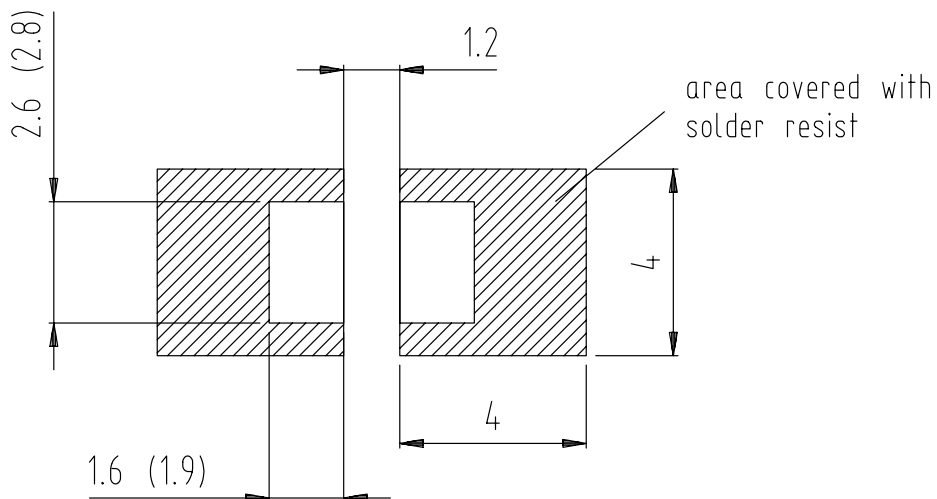

Dimensions: IR and Vaporphase
(Wave Soldering)

95 10966

Ozone Depleting Substances Policy Statement

It is the policy of **Vishay Semiconductor GmbH** to

1. Meet all present and future national and international statutory requirements.
2. Regularly and continuously improve the performance of our products, processes, distribution and operating systems with respect to their impact on the health and safety of our employees and the public, as well as their impact on the environment.

It is particular concern to control or eliminate releases of those substances into the atmosphere which are known as ozone depleting substances (ODSs).

The Montreal Protocol (1987) and its London Amendments (1990) intend to severely restrict the use of ODSs and forbid their use within the next ten years. Various national and international initiatives are pressing for an earlier ban on these substances.

Vishay Semiconductor GmbH has been able to use its policy of continuous improvements to eliminate the use of ODSs listed in the following documents.

1. Annex A, B and list of transitional substances of the Montreal Protocol and the London Amendments respectively
2. Class I and II ozone depleting substances in the Clean Air Act Amendments of 1990 by the Environmental Protection Agency (EPA) in the USA
3. Council Decision 88/540/EEC and 91/690/EEC Annex A, B and C (transitional substances) respectively.

Vishay Semiconductor GmbH can certify that our semiconductors are not manufactured with ozone depleting substances and do not contain such substances.

We reserve the right to make changes to improve technical design and may do so without further notice.

Parameters can vary in different applications. All operating parameters must be validated for each customer application by the customer. Should the buyer use Vishay Semiconductors products for any unintended or unauthorized application, the buyer shall indemnify Vishay Semiconductors against all claims, costs, damages, and expenses, arising out of, directly or indirectly, any claim of personal damage, injury or death associated with such unintended or unauthorized use.

Vishay Semiconductor GmbH, P.O.B. 3535, D-74025 Heilbronn, Germany
Telephone: 49 (0)7131 67 2831, Fax number: 49 (0)7131 67 2423