

# TLP115A

High Speed, Long Distance Isolated Line Receiver  
 Microprocessor System Interfaces  
 Digital Isolation For A / D, D / A Conversion  
 Computer-Peripheral Interfaces  
 Ground Loop Elimination

The TOSHIBA mini flat coupler TLP115A is a small outline coupler, suitable for surface mount assembly. TLP115A consists of a high output power GaAlAs light emitting diode, optically coupled to an integrated high gain, high speed shielded photo detector whose output is an open collector schottky clamped transistor. The shield, which shunts capacitively coupled common noise to ground, provides a guaranteed transient immunity specification of 1000V /  $\mu$ s.

- Input current thresholds:  $I_F = 5\text{mA}$  (max.)
- Switching speed: 10MBd (typ.)
- Common mode transient immunity:  $\pm 1000\text{V} / \mu\text{s}$  (min.)
- Guaranteed performance over temp. : 0~70°C
- Isolation voltage: 2500Vrms (min.)
- UL recognized: UL1577, file no. E67349

### Schematic

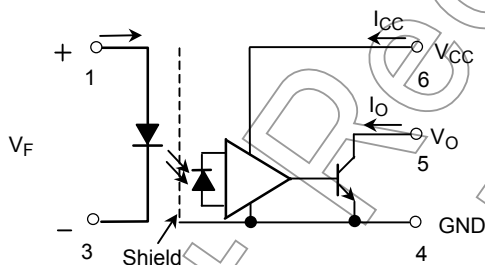

Note. A 0.1 $\mu$ F bypass capacitor must be connected between pins 4 and 6.

Unit in mm

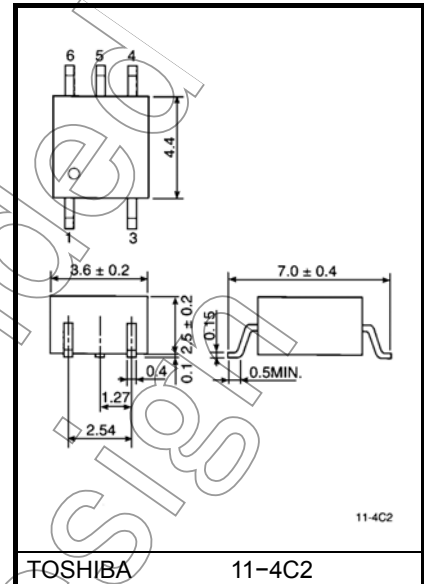

Weight: 0.09 g (typ.)

### Pin Configuration (top view)

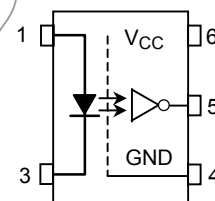

- 1 : Anode
- 3 : Cathode
- 4 : GND
- 5 : V<sub>O</sub>(Output)
- 6 : V<sub>CC</sub>

### Truth Table (positive logic)

Input	Output
H	L
L	H

## Absolute Maximum Ratings (Ta = 25°C)

Characteristic		Symbol	Rating	Unit
LED	Forward current (Note 1)	I <sub>F</sub>	20	mA
	Pulse forward current (Note 2)	I <sub>FP</sub>	40	mA
	Peak transient forward current (Note 3)	I <sub>FPT</sub>	1	A
	Reverse voltage	V <sub>R</sub>	5	V
Detector	Output current	I <sub>O</sub>	25	mA
	Output voltage	V <sub>O</sub>	7	V
	Supply voltage(1 minute maximum)	V <sub>CC</sub>	7	V
	Output power dissipation	P <sub>o</sub>	40	mW
Operating temperature range		T <sub>opr</sub>	-40~85	°C
Storage temperature range		T <sub>stg</sub>	-55~125	°C
Lead solder temperature(10 sec.)		T <sub>sol</sub>	260	°C
Isolation voltage(AC, 1 min., RH≤ 60%, Note 4)		BV <sub>S</sub>	2500	V <sub>rms</sub>

Note: Using continuously under heavy loads (e.g. the application of high temperature/current/voltage and the significant change in temperature, etc.) may cause this product to decrease in the reliability significantly even if the operating conditions (i.e. operating temperature/current/voltage, etc.) are within the absolute maximum ratings.

Please design the appropriate reliability upon reviewing the Toshiba Semiconductor Reliability Handbook ("Handling Precautions"/"Derating Concept and Methods") and individual reliability data (i.e. reliability test report and estimated failure rate, etc).

(Note 1) Derate 0.36mA / °C above 70°C.

(Note 2) 50% duty cycle, 1ms pulse width. Derate 0.72mA / °C above 70°C.

(Note 3) Pulse width ≤ 1μs, 300pps.

## Recommended Operating Conditions

Characteristic	Symbol	Min.	Typ.	Max.	Unit
Input voltage, low level	V <sub>FL</sub>	-3	0	1.0	V
Input current, high level	I <sub>FH</sub>	6.3	8	20	mA
Supply voltage	V <sub>CC</sub>	4.5	5	5.5	V
Fan out (TTL load, each channel)	N	—	—	8	—
Operating temperature	T <sub>opr</sub>	0	—	70	°C

Note: Recommended operating conditions are given as a design guideline to obtain expected performance of the device. Additionally, each item is an independent guideline respectively. In developing designs using this product, please confirm specified characteristics shown in this document.

**Electrical Characteristics (unless otherwise specified, Ta = 0~70°C, VCC = 4.5 ~ 5.5V, VFL ≤ 1.0V)**

Characteristic	Symbol	Test Condition	Min.	Typ.	Max.	Unit
Forward voltage	V <sub>F</sub>	I <sub>F</sub> = 10mA, Ta = 25°C	1.2	1.4	1.7	V
Forward voltage temperature coefficient	V <sub>F</sub> / Ta	I <sub>F</sub> = 10mA	—	-2	—	mV / °C
Reverse current	I <sub>R</sub>	V <sub>R</sub> = 3V, Ta = 25°C	—	—	10	μA
Capacitance between terminals	C <sub>T</sub>	V <sub>F</sub> = 0, f = 1MHz, Ta = 25°C	—	30	—	pF
High level output voltage	I <sub>OH</sub>	V <sub>F</sub> = 1.0, V <sub>O</sub> = 5.5V	—	—	250	μA
		V <sub>F</sub> = 1.0, V <sub>O</sub> = 5.5V, Ta = 25°C	—	0.5	10	
Low level output current	V <sub>OL</sub>	I <sub>F</sub> = 5mA I <sub>OL</sub> = 13mA (sinking)	—	0.4	0.6	V
"H level output→L level output" input current	I <sub>FH</sub>	I <sub>OL</sub> = 13mA (sinking) V <sub>OL</sub> = 0.6V	—	—	5	mA
High level supply current	I <sub>CCH</sub>	V <sub>CC</sub> = 5.5V, I <sub>F</sub> = 0	—	7	15	mA
Low level supply current	I <sub>CCL</sub>	V <sub>CC</sub> = 5.5V, I <sub>F</sub> = 10mA	—	12	19	mA
Input-output insulation leakage current	I <sub>S</sub>	V <sub>S</sub> = 3540V, t = 5s Ta = 25°C (Note 4)	—	—	100	μA
Isolation resistance	R <sub>S</sub>	R.H. ≤ 60%, V <sub>S</sub> = 500V DC Ta = 25°C (Note 4)	5 × 10 <sup>10</sup>	10 <sup>14</sup>	—	Ω
Stray capacitance between input to output	C <sub>S</sub>	V <sub>S</sub> = 0, f = 1MHz Ta = 25°C (Note 4)	—	0.8	—	pF

\* All typical values are V<sub>CC</sub> = 5V, Ta = 25°C.

Not Recommended for New Design

## Switching Characteristics ( $V_{CC} = 5V$ , $T_a = 25^\circ C$ )

Characteristic	Symbol	Test Circuit	Test Condition	Min.	Typ.	Max.	Unit
Propagation delay time (H→L)	$t_{pHL}$	1	$I_F = 0 \rightarrow 7.5mA$ $C_L = 15pF$ , $R_L = 350\Omega$	—	60	120	ns
Propagation delay time (L→H)	$t_{pLH}$	1	$I_F = 7.5 \rightarrow 0mA$ $C_L = 15pF$ , $R_L = 350\Omega$	—	60	120	ns
Output rise fall time(10–90%)	$t_r$ , $t_f$	2	$R_L = 350$ , $C_L = 15pF$ $I_F = 0 \leftrightarrow 7.5mA$	—	30	—	ns
Common mode transient immunity at high output level	$CM_H$	2	$I_F = 0 mA$ , $V_{CM} = 400V_{p-p}$ , $V_{O(MIN)} = 2V$ $R_L = 350\Omega$	1000	—	—	V / $\mu s$
Common mode transient immunity at low output level	$CM_L$	2	$I_F = 7.5 mA$ , $V_{CM} = 400V_{p-p}$ $V_{O(MAX)} = 0.8V$ , $R_L = 350\Omega$	-1000	—	—	V / $\mu s$

(Note 4) Device considered a two-terminal device: Pins 1 and 3 shorted together, and pins 4, 5 and 6 shorted together.

(Note 5) The  $V_{CC}$  supply voltage to each TLP115A isolator must be bypassed by 0.1 $\mu F$  capacitor. This can be either a ceramic or solid tantalum capacitor with good high frequency characteristic and should be connected as close as possible to package  $V_{CC}$  and GND pins of each device.

(Note 6) Maximum electrostatic discharge voltage for any pins: 180V(C = 200pF, R = 0)

Not Recommended for New Design

**Test Circuit 1: Switching Time Test Circuit**

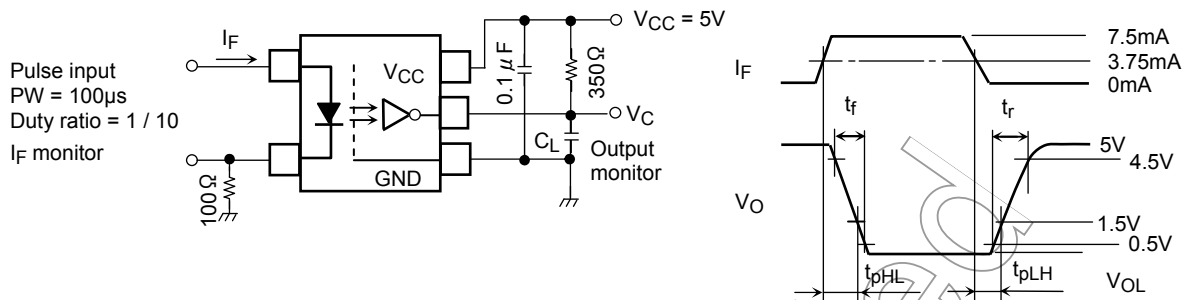

C<sub>L</sub> is approximately 15pF which includes probe and stray wiring capacitance.

**Test Circuit 2: Common Mode Transient Immunity Test Circuit**

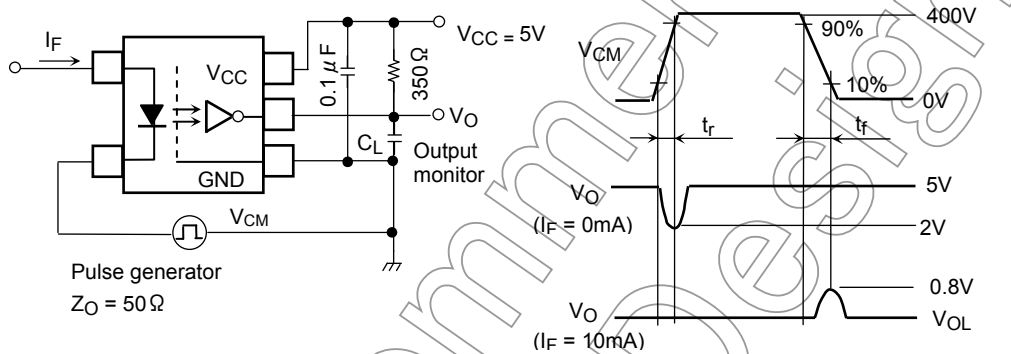

$$CM_H = \frac{320 \text{ (V)}}{t_r \text{ (}\mu\text{s)}}, CM_L = \frac{320 \text{ (V)}}{t_f \text{ (}\mu\text{s)}}$$

C<sub>L</sub> is approximately 15pF which includes probe and stray wiring capacitance.

Not Recommended for New Design

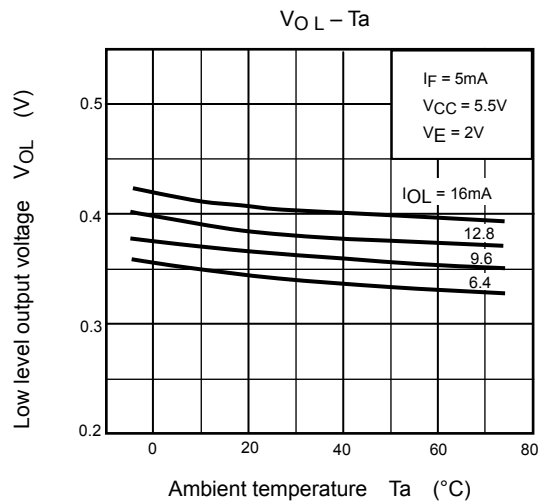
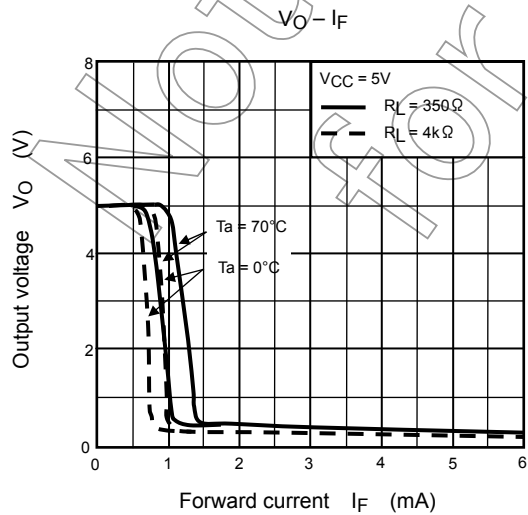
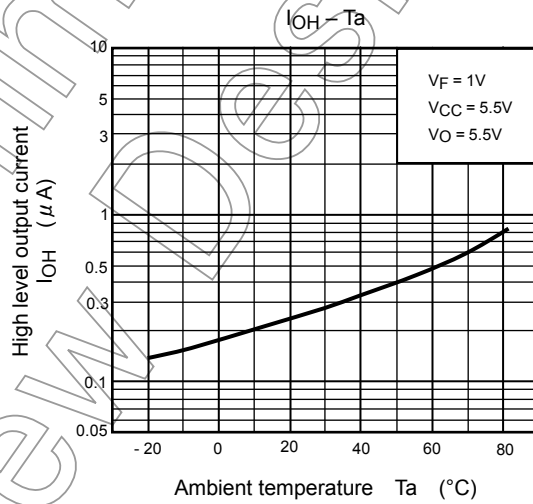
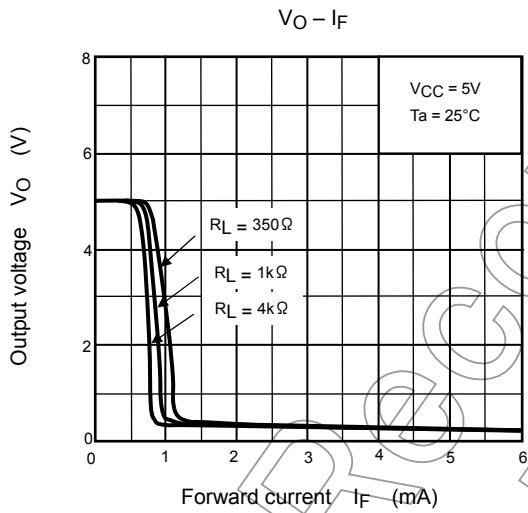
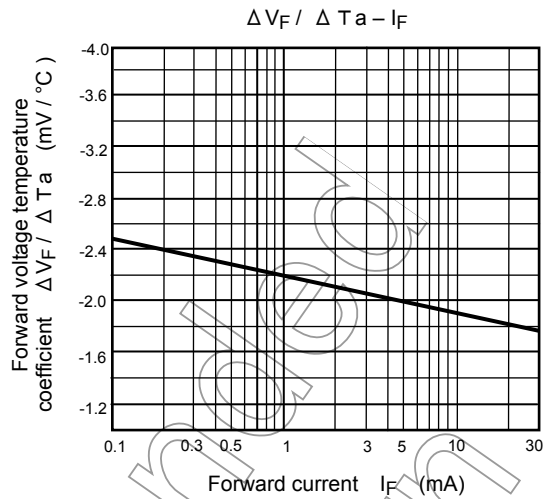
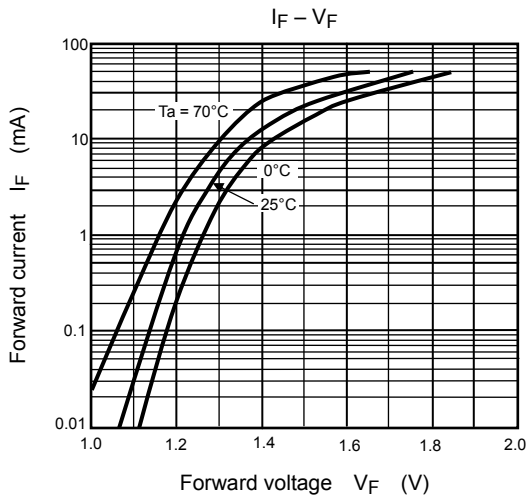

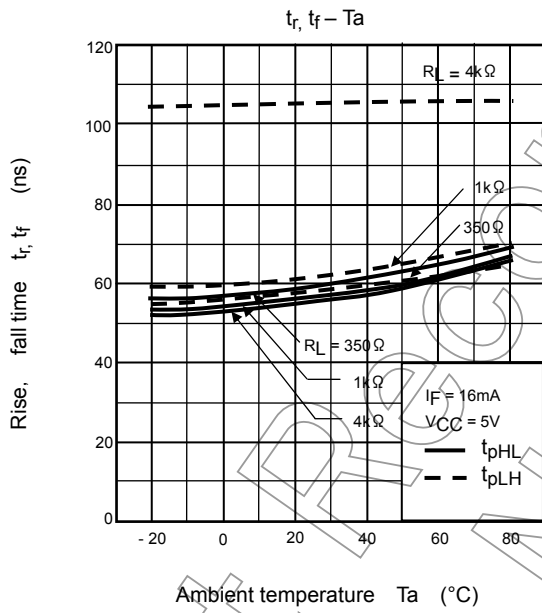
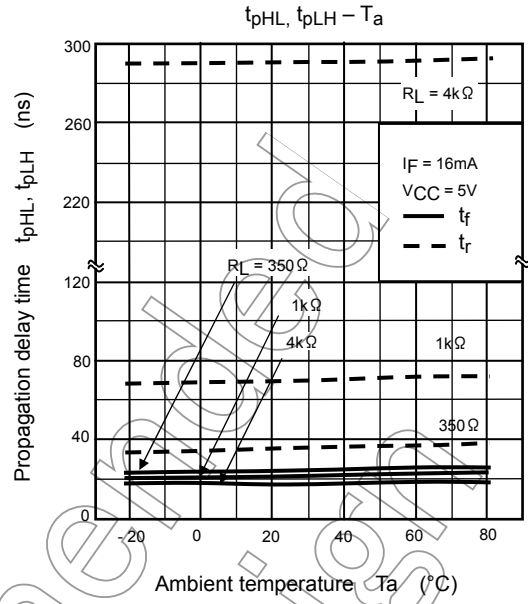
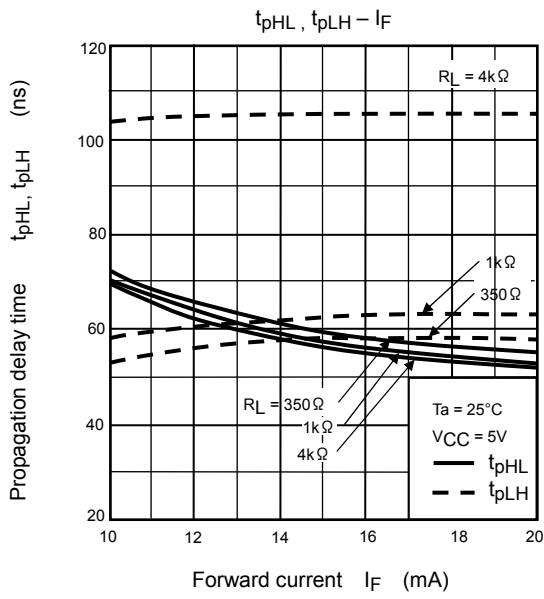

## RESTRICTIONS ON PRODUCT USE

- Toshiba Corporation, and its subsidiaries and affiliates (collectively "TOSHIBA"), reserve the right to make changes to the information in this document, and related hardware, software and systems (collectively "Product") without notice.
- This document and any information herein may not be reproduced without prior written permission from TOSHIBA. Even with TOSHIBA's written permission, reproduction is permissible only if reproduction is without alteration/omission.
- Though TOSHIBA works continually to improve Product's quality and reliability, Product can malfunction or fail. Customers are responsible for complying with safety standards and for providing adequate designs and safeguards for their hardware, software and systems which minimize risk and avoid situations in which a malfunction or failure of Product could cause loss of human life, bodily injury or damage to property, including data loss or corruption. Before creating and producing designs and using, customers must also refer to and comply with (a) the latest versions of all relevant TOSHIBA information, including without limitation, this document, the specifications, the data sheets and application notes for Product and the precautions and conditions set forth in the "TOSHIBA Semiconductor Reliability Handbook" and (b) the instructions for the application that Product will be used with or for. Customers are solely responsible for all aspects of their own product design or applications, including but not limited to (a) determining the appropriateness of the use of this Product in such design or applications; (b) evaluating and determining the applicability of any information contained in this document, or in charts, diagrams, programs, algorithms, sample application circuits, or any other referenced documents; and (c) validating all operating parameters for such designs and applications. **TOSHIBA ASSUMES NO LIABILITY FOR CUSTOMERS' PRODUCT DESIGN OR APPLICATIONS.**
- Product is intended for use in general electronics applications (e.g., computers, personal equipment, office equipment, measuring equipment, industrial robots and home electronics appliances) or for specific applications as expressly stated in this document. Product is neither intended nor warranted for use in equipment or systems that require extraordinarily high levels of quality and/or reliability and/or a malfunction or failure of which may cause loss of human life, bodily injury, serious property damage or serious public impact ("Unintended Use"). Unintended Use includes, without limitation, equipment used in nuclear facilities, equipment used in the aerospace industry, medical equipment, equipment used for automobiles, trains, ships and other transportation, traffic signaling equipment, equipment used to control combustions or explosions, safety devices, elevators and escalators, devices related to electric power, and equipment used in finance-related fields. Do not use Product for Unintended Use unless specifically permitted in this document.
- Do not disassemble, analyze, reverse-engineer, alter, modify, translate or copy Product, whether in whole or in part.
- Product shall not be used for or incorporated into any products or systems whose manufacture, use, or sale is prohibited under any applicable laws or regulations.
- The information contained herein is presented only as guidance for Product use. No responsibility is assumed by TOSHIBA for any infringement of patents or any other intellectual property rights of third parties that may result from the use of Product. No license to any intellectual property right is granted by this document, whether express or implied, by estoppel or otherwise.
- **ABSENT A WRITTEN SIGNED AGREEMENT, EXCEPT AS PROVIDED IN THE RELEVANT TERMS AND CONDITIONS OF SALE FOR PRODUCT, AND TO THE MAXIMUM EXTENT ALLOWABLE BY LAW, TOSHIBA (1) ASSUMES NO LIABILITY WHATSOEVER, INCLUDING WITHOUT LIMITATION, INDIRECT, CONSEQUENTIAL, SPECIAL, OR INCIDENTAL DAMAGES OR LOSS, INCLUDING WITHOUT LIMITATION, LOSS OF PROFITS, LOSS OF OPPORTUNITIES, BUSINESS INTERRUPTION AND LOSS OF DATA, AND (2) DISCLAIMS ANY AND ALL EXPRESS OR IMPLIED WARRANTIES AND CONDITIONS RELATED TO SALE, USE OF PRODUCT, OR INFORMATION, INCLUDING WARRANTIES OR CONDITIONS OF MERCHANTABILITY, FITNESS FOR A PARTICULAR PURPOSE, ACCURACY OF INFORMATION, OR NONINFRINGEMENT.**
- GaAs (Gallium Arsenide) is used in Product. GaAs is harmful to humans if consumed or absorbed, whether in the form of dust or vapor. Handle with care and do not break, cut, crush, grind, dissolve chemically or otherwise expose GaAs in Product.
- Do not use or otherwise make available Product or related software or technology for any military purposes, including without limitation, for the design, development, use, stockpiling or manufacturing of nuclear, chemical, or biological weapons or missile technology products (mass destruction weapons). Product and related software and technology may be controlled under the Japanese Foreign Exchange and Foreign Trade Law and the U.S. Export Administration Regulations. Export and re-export of Product or related software or technology are strictly prohibited except in compliance with all applicable export laws and regulations.
- Please contact your TOSHIBA sales representative for details as to environmental matters such as the RoHS compatibility of Product. Please use Product in compliance with all applicable laws and regulations that regulate the inclusion or use of controlled substances, including without limitation, the EU RoHS Directive. TOSHIBA assumes no liability for damages or losses occurring as a result of noncompliance with applicable laws and regulations.