

TOSHIBA Photocoupler GaAs Ired & Photo-Transistor

TLP124

Office Machine
 Programmable Controllers
 AC / DC-Input Module
 Telecommunication

The TOSHIBA mini flat coupler TLP124 is a small outline coupler, suitable for surface mount assembly. TLP124 consists of a photo transistor optically coupled to a gallium arsenide infrared emitting diode.

- Collector-emitter voltage: 80 V (min)
- Current transfer ratio: 100% (min)
 Rank BV: 200% (min)
- Isolation voltage: 3750Vrms (min)
- UL recognized: UL1577, file No. E67349

Unit: mm

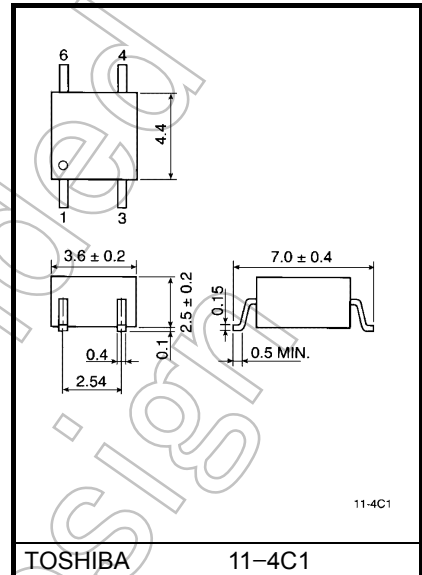

Weight: 0.09g (typ.)

Pin Configurations (top view)

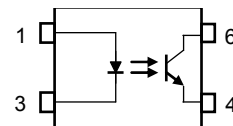

- 1 : Anode
- 3 : Cathode
- 4 : Emitter
- 6 : Collector

Not Recommended for New Design

Start of commercial production
 1988/04

Current Transfer Ratio

Classification	Current Transfer Ratio (min.)			Marking of Classification
	Ta = 25°C		Ta = -25~75°C	
	If = 1mA VCE = 0.5V	If = 0.5mA VCE = 1.5V	If = 1mA VCE = 0.5V	
Rank BV	200%	100%	100%	BV
Standard	100%	50%	50%	BV, Blank

(Note) Application type name for certification test, please use standard product type name, i. e. TLP124 (BV): TLP124

Absolute Maximum Ratings (Ta = 25°C)

Characteristic		Symbol	Rating	Unit
LED	Forward current	If	50	mA
	Forward current derating	$\Delta I_F / ^\circ C$	-0.7 (Ta ≥ 53°C)	mA / °C
	Peak forward current (100µs pulse, 100pps)	Ifp	1	A
	Reverse voltage	VR	5	V
	Junction temperature	Tj	125	°C
Detector	Collector-emitter voltage	VCEO	80	V
	Emitter-collector voltage	VECO	7	V
	Collector current	IC	50	mA
	Peak collector current (10ms pulse, 100pps)	ICP	100	mA
	Power dissipation	PC	150	mW
	Power dissipation derating (Ta ≥ 25°C)	$\Delta P_C / ^\circ C$	-1.5	mW / °C
	Junction temperature	Tj	125	°C
Storage temperature range		Tstg	-55~125	°C
Operating temperature range		Topr	-55~100	°C
Lead soldering temperature (10s)		Tsol	260	°C
Total package power dissipation		PT	200	mW
Total package power dissipation derating (Ta ≥ 25°C)		$\Delta P_T / ^\circ C$	-2.0	mW / °C
Isolation voltage (AC, 1 minute, R.H. ≤ 60%) (Note 1)		BVs	3750	Vrms

Note: Using continuously under heavy loads (e.g. the application of high temperature/current/voltage and the significant change in temperature, etc.) may cause this product to decrease in the reliability significantly even if the operating conditions (i.e. operating temperature/current/voltage, etc.) are within the absolute maximum ratings.

Please design the appropriate reliability upon reviewing the Toshiba Semiconductor Reliability Handbook ("Handling Precautions"/"Derating Concept and Methods") and individual reliability data (i.e. reliability test report and estimated failure rate, etc.).

(Note 1) Device considered a two terminal device: Pins 1, 3 shorted together and pins 4, 6 shorted together.

Recommended Operating Conditions

Characteristic	Symbol	Min	Typ.	Max	Unit
Supply voltage	V_{CC}	—	5	48	V
Forward current	I_F	—	1.6	20	mA
Collector current	I_C	—	1	10	mA
Operating temperature	T_{opr}	-25	—	75	°C

Note: Recommended operating conditions are given as a design guideline to obtain expected performance of the device. Additionally, each item is an independent guideline respectively. In developing designs using this product, please confirm specified characteristics shown in this document.

Individual Electrical Characteristics (Ta = 25°C)

Characteristic		Symbol	Test Condition	Min	Typ.	Max	Unit
LED	Forward voltage	V_F	$I_F = 10 \text{ mA}$	1.0	1.15	1.3	V
	Reverse Current	I_R	$V_R = 5 \text{ V}$	—	—	10	μA
	Capacitance	C_T	$V = 0, f = 1 \text{ MHz}$	—	30	—	pF
Detector	Collector-emitter breakdown voltage	$V_{(BR)CEO}$	$I_C = 0.5 \text{ mA}$	80	—	—	V
	Emitter-collector breakdown voltage	$V_{(BR)ECO}$	$I_E = 0.1 \text{ mA}$	7	—	—	V
	Collector dark current	I_D	$V_{CE} = 48 \text{ V}$ $V_{CE} = 48 \text{ V}, T_a = 85^\circ\text{C}$	—	10	100	nA μA
	Capacitance collector to emitter	C_{CE}	$V = 0, f = 1 \text{ MHz}$	—	12	—	pF

Coupled Electrical Characteristics (Ta = 25°C)

Characteristic	Symbol	Test Condition	Min	Typ.	Max	Unit
Current transfer ratio	I_C / I_F	$I_F = 1 \text{ mA}, V_{CE} = 0.5 \text{ V}$ Rank BV	100	—	1200	%
			200	—	1200	
Low input CTR	$I_C / I_F (\text{low})$	$I_F = 0.5 \text{ mA}, V_{CE} = 1.5 \text{ V}$ Rank BV	50	—	—	%
			100	—	—	
Collector-emitter saturation voltage	$V_{CE} (\text{sat})$	$I_C = 0.5 \text{ mA}, I_F = 1 \text{ mA}$ $I_C = 1 \text{ mA}, I_F = 1 \text{ mA}$ Rank BV	—	—	0.4	V
			—	0.2	—	
			—	—	0.4	
Off-state collector current	$I_{C(\text{off})}$	$V_F = 0.7 \text{ V}, V_{CE} = 48 \text{ V}$	—	—	10	μA

Coupled Electrical Characteristics (Ta = -25~75°C)

Characteristic	Symbol	Test Condition	Min	Typ.	Max	Unit
Current transfer ratio	I_C / I_F	$I_F = 1 \text{ mA}, V_{CE} = 0.5 \text{ V}$ Rank BV	50	—	—	%
			100	—	—	
Low input CTR	$I_C / I_F (\text{low})$	$I_F = 0.5 \text{ mA}, V_{CE} = 1.5 \text{ V}$ Rank BV	—	50	—	%
			—	100	—	

Isolation Characteristics (Ta = 25°C)

Characteristic	Symbol	Test Condition	Min	Typ.	Max	Unit
Capacitance (input to output)	C _S	V _S = 0, f = 1 MHz	—	0.8	—	pF
Isolation resistance	R _S	V _S = 500 V, R.H. ≤ 60%	5×10 ¹⁰	10 ¹⁴	—	Ω
Isolation voltage	BV _S	AC, 1 minute	3750	—	—	V _{rms}
		AC, 1 second, in oil	—	10000	—	
		DC, 1 minute, in oil	—	10000	—	V _{dc}

Switching Characteristics (Ta = 25°C)

Characteristic	Symbol	Test Condition	Min	Typ.	Max	Unit
Rise time	t _r	V _{CC} = 10 V, I _C = 2 mA R _L = 100Ω	—	8	—	μs
Fall time	t _f		—	8	—	
Turn-on time	t _{ON}		—	10	—	
Turn-off time	t _{OFF}		—	8	—	
Turn-on time	t _{ON}	R _L = 4.7 kΩ V _{CC} = 5 V, I _F = 1.6 mA (Fig.1)	—	10	—	μs
Storage time	t _s		—	50	—	
Turn-off time	t _{OFF}		—	300	—	

Fig. 1 Switching time test circuit

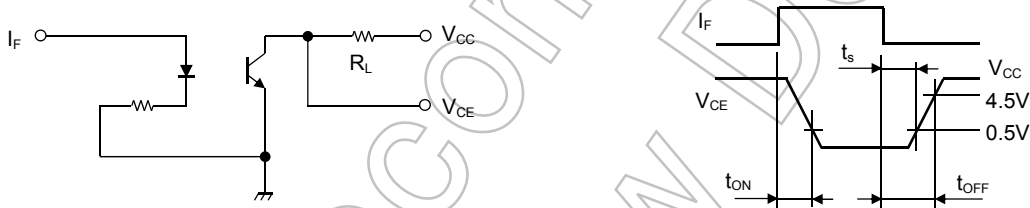

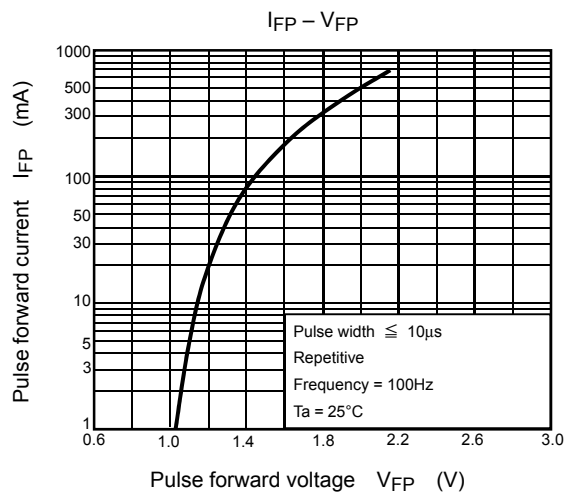
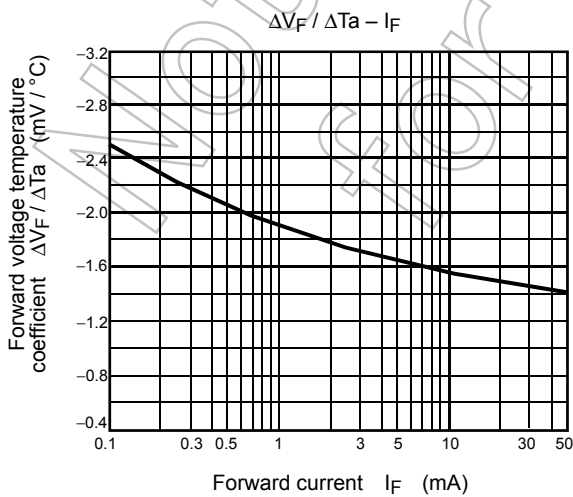
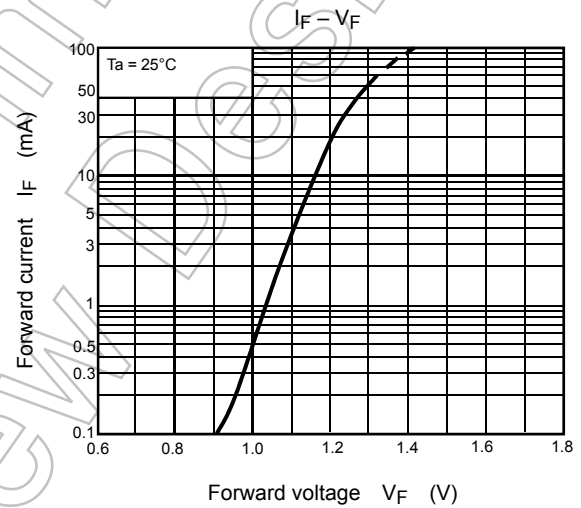
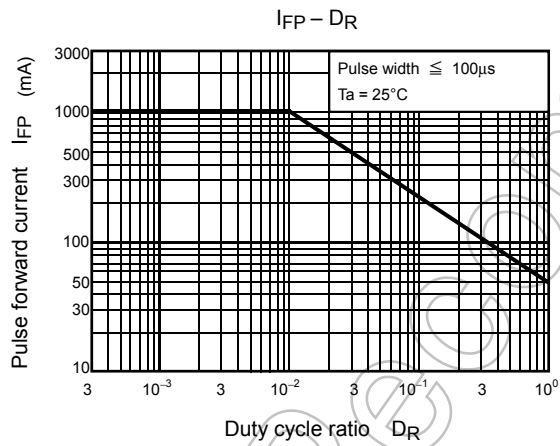
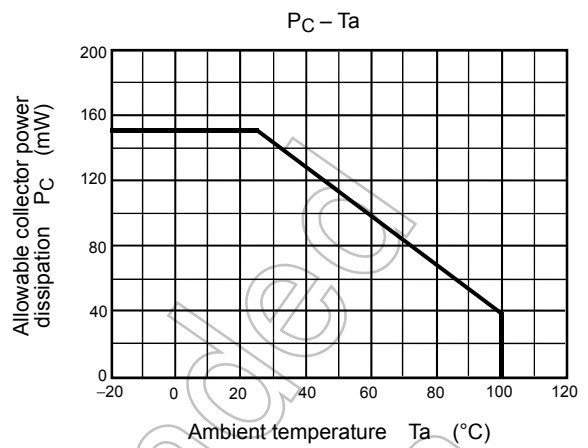
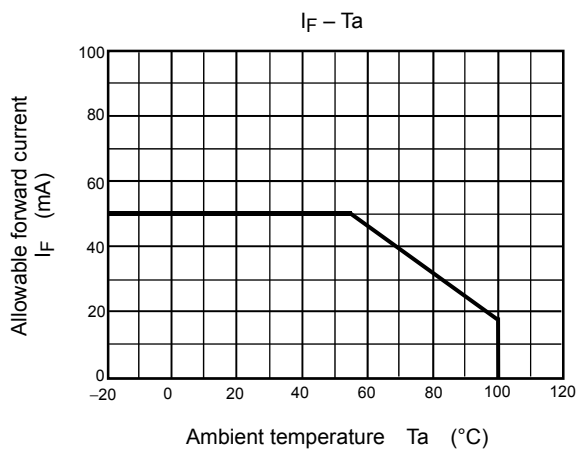

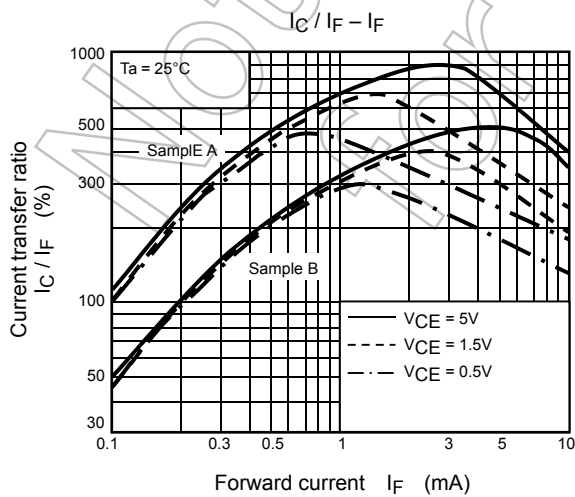
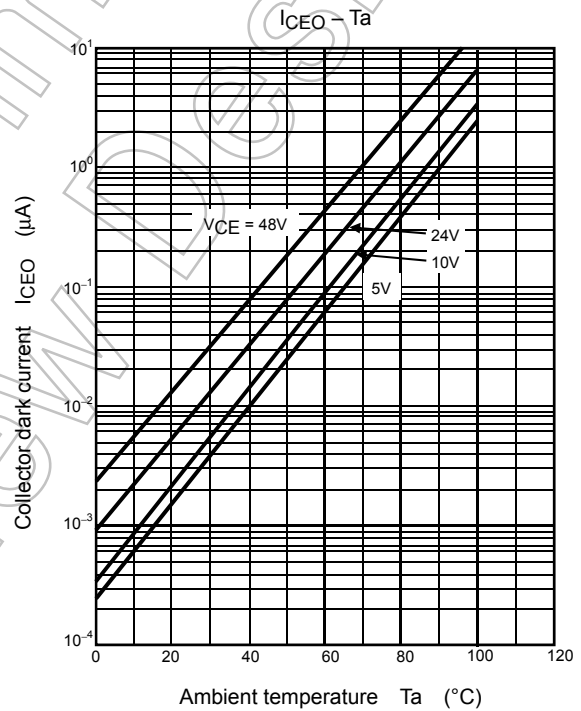
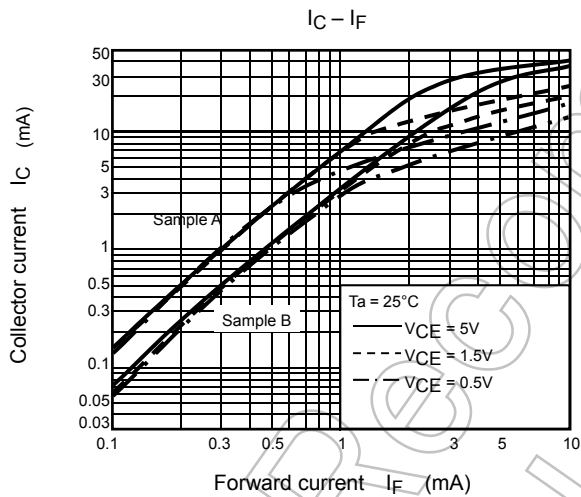
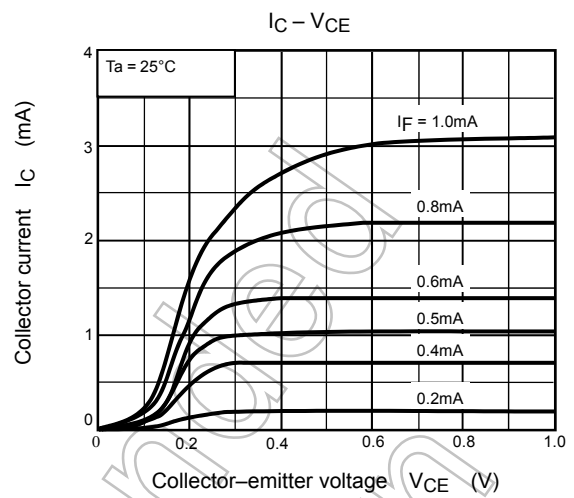
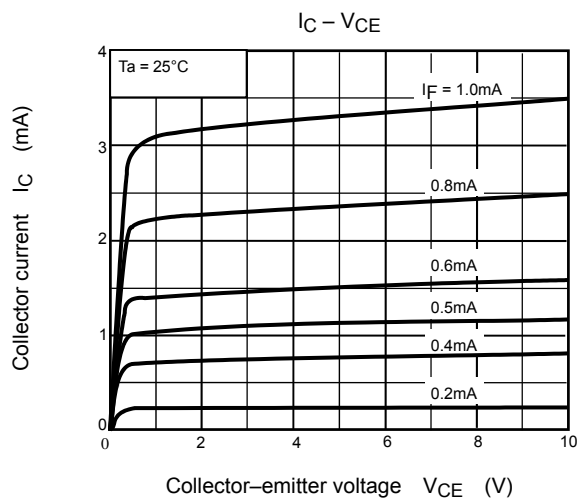

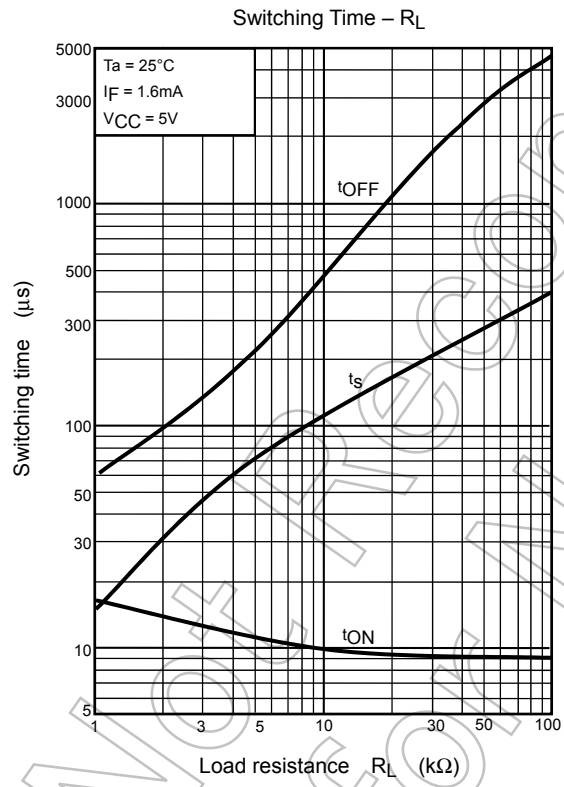
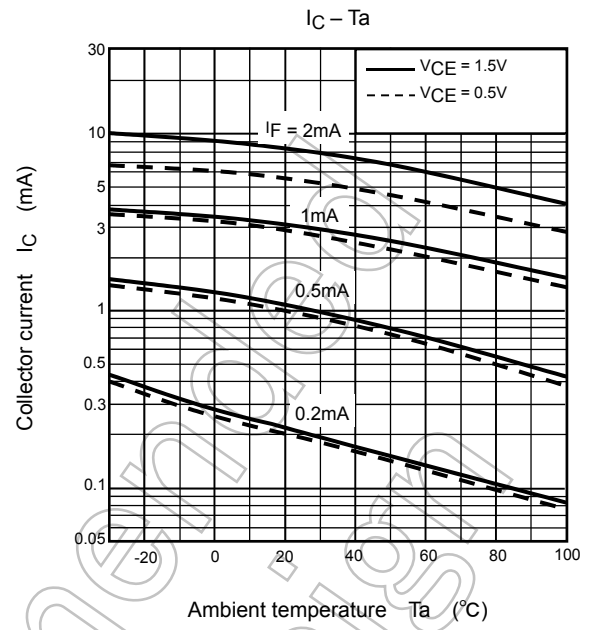
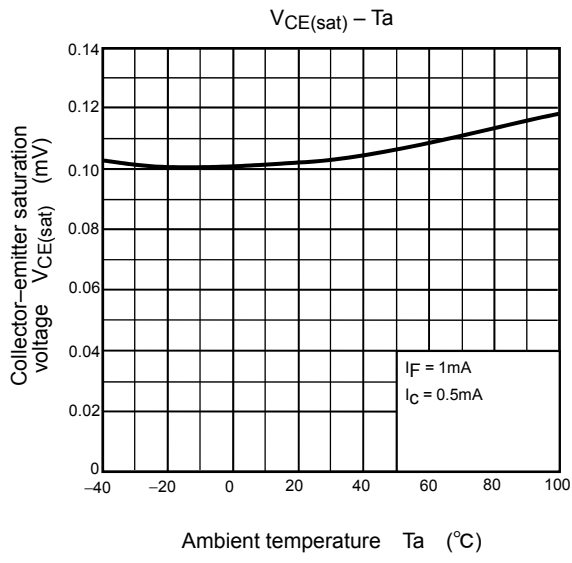

RESTRICTIONS ON PRODUCT USE

- Toshiba Corporation, and its subsidiaries and affiliates (collectively "TOSHIBA"), reserve the right to make changes to the information in this document, and related hardware, software and systems (collectively "Product") without notice.
- This document and any information herein may not be reproduced without prior written permission from TOSHIBA. Even with TOSHIBA's written permission, reproduction is permissible only if reproduction is without alteration/omission.
- Though TOSHIBA works continually to improve Product's quality and reliability, Product can malfunction or fail. Customers are responsible for complying with safety standards and for providing adequate designs and safeguards for their hardware, software and systems which minimize risk and avoid situations in which a malfunction or failure of Product could cause loss of human life, bodily injury or damage to property, including data loss or corruption. Before customers use the Product, create designs including the Product, or incorporate the Product into their own applications, customers must also refer to and comply with (a) the latest versions of all relevant TOSHIBA information, including without limitation, this document, the specifications, the data sheets and application notes for Product and the precautions and conditions set forth in the "TOSHIBA Semiconductor Reliability Handbook" and (b) the instructions for the application with which the Product will be used with or for. Customers are solely responsible for all aspects of their own product design or applications, including but not limited to (a) determining the appropriateness of the use of this Product in such design or applications; (b) evaluating and determining the applicability of any information contained in this document, or in charts, diagrams, programs, algorithms, sample application circuits, or any other referenced documents; and (c) validating all operating parameters for such designs and applications. **TOSHIBA ASSUMES NO LIABILITY FOR CUSTOMERS' PRODUCT DESIGN OR APPLICATIONS.**
- **PRODUCT IS NEITHER INTENDED NOR WARRANTED FOR USE IN EQUIPMENTS OR SYSTEMS THAT REQUIRE EXTRAORDINARILY HIGH LEVELS OF QUALITY AND/OR RELIABILITY, AND/OR A MALFUNCTION OR FAILURE OF WHICH MAY CAUSE LOSS OF HUMAN LIFE, BODILY INJURY, SERIOUS PROPERTY DAMAGE AND/OR SERIOUS PUBLIC IMPACT ("UNINTENDED USE").** Except for specific applications as expressly stated in this document, Unintended Use includes, without limitation, equipment used in nuclear facilities, equipment used in the aerospace industry, medical equipment, equipment used for automobiles, trains, ships and other transportation, traffic signaling equipment, equipment used to control combustions or explosions, safety devices, elevators and escalators, devices related to electric power, and equipment used in finance-related fields. **IF YOU USE PRODUCT FOR UNINTENDED USE, TOSHIBA ASSUMES NO LIABILITY FOR PRODUCT.** For details, please contact your TOSHIBA sales representative.
- Do not disassemble, analyze, reverse-engineer, alter, modify, translate or copy Product, whether in whole or in part.
- Product shall not be used for or incorporated into any products or systems whose manufacture, use, or sale is prohibited under any applicable laws or regulations.
- The information contained herein is presented only as guidance for Product use. No responsibility is assumed by TOSHIBA for any infringement of patents or any other intellectual property rights of third parties that may result from the use of Product. No license to any intellectual property right is granted by this document, whether express or implied, by estoppel or otherwise.
- **ABSENT A WRITTEN SIGNED AGREEMENT, EXCEPT AS PROVIDED IN THE RELEVANT TERMS AND CONDITIONS OF SALE FOR PRODUCT, AND TO THE MAXIMUM EXTENT ALLOWABLE BY LAW, TOSHIBA (1) ASSUMES NO LIABILITY WHATSOEVER, INCLUDING WITHOUT LIMITATION, INDIRECT, CONSEQUENTIAL, SPECIAL, OR INCIDENTAL DAMAGES OR LOSS, INCLUDING WITHOUT LIMITATION, LOSS OF PROFITS, LOSS OF OPPORTUNITIES, BUSINESS INTERRUPTION AND LOSS OF DATA, AND (2) DISCLAIMS ANY AND ALL EXPRESS OR IMPLIED WARRANTIES AND CONDITIONS RELATED TO SALE, USE OF PRODUCT, OR INFORMATION, INCLUDING WARRANTIES OR CONDITIONS OF MERCHANTABILITY, FITNESS FOR A PARTICULAR PURPOSE, ACCURACY OF INFORMATION, OR NONINFRINGEMENT.**
- GaAs (Gallium Arsenide) is used in Product. GaAs is harmful to humans if consumed or absorbed, whether in the form of dust or vapor. Handle with care and do not break, cut, crush, grind, dissolve chemically or otherwise expose GaAs in Product.
- Do not use or otherwise make available Product or related software or technology for any military purposes, including without limitation, for the design, development, use, stockpiling or manufacturing of nuclear, chemical, or biological weapons or missile technology products (mass destruction weapons). Product and related software and technology may be controlled under the applicable export laws and regulations including, without limitation, the Japanese Foreign Exchange and Foreign Trade Law and the U.S. Export Administration Regulations. Export and re-export of Product or related software or technology are strictly prohibited except in compliance with all applicable export laws and regulations.
- Please contact your TOSHIBA sales representative for details as to environmental matters such as the RoHS compatibility of Product. Please use Product in compliance with all applicable laws and regulations that regulate the inclusion or use of controlled substances, including without limitation, the EU RoHS Directive. **TOSHIBA ASSUMES NO LIABILITY FOR DAMAGES OR LOSSES OCCURRING AS A RESULT OF NONCOMPLIANCE WITH APPLICABLE LAWS AND REGULATIONS.**