

# Analogue Temperature Controller E5C2

## DIN-sized (48 x 48 mm) Temperature Controller with Analog Setting

- Compact, low-cost Temperature Controller.
- Incorporates proportional control and reset adjustment function.
- Consecutive mounting possible using mounting adapter.
- Incorporates a plug-in socket, thus allows to DIN-track and flush mounting.

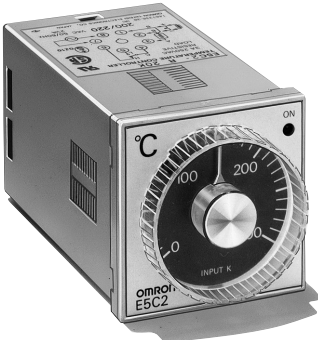

## Model Number Structure

### Model Number Legend

E5C2- □ □ □ □  
1 2 3 4 5

- |  |   |
|--|---|
| <p><b>1. Model name</b></p> <p><b>2. Control output</b><br/>R: Relay<br/>Q: Voltage</p> <p><b>3. Control method</b><br/>20: ON-OFF control<br/>40: P control</p> | <p><b>4. Input type</b><br/>K: K-type thermocouple<br/>L: J-type thermocouple<br/>P: Platinum resistance thermometer (PT100)<br/>G: Thermistor (THE)</p> <p><b>5. Special type</b><br/>Blank: Standard type<br/>D, DIN: Special types</p> |
|--|---|

## Ordering Information

### Temperature Controllers

Setting method	Indication method	Control mode	Output	Model			
				Thermocouple		Platinum resistance thermometer Pt100	Thermistor THE
				K (CA) Chromel vs. alumel	L (IC) Iron vs. constantan		
Analog setting	No indication	ON/OFF	Relay	E5C2-R20K	E5C2-R20L-D	E5C2-R20P-D	E5C2-R20G
		P	Relay	E5C2-R40K	E5C2-R40L-D	E5C2-R40P-D	---

**Note:** When placing an order, specify the standard temperature range and supply voltage in addition to the model number.  
(e.g., E5C2-R20K 0°C to 200°C 100/110 VAC)

### Accessories (Order Separately)

Name	Model
Front Connecting Socket	P2CF-08
Back Connecting Socket (for flush mounting)	P3G-08
Front Connecting Socket with Finger Protection	P2CF-08-E
Protective Cover (for finger protection)	Y92A-48G

Temperature Controller

# Specifications

## ■ Ratings

Supply voltage	100/110/120 VAC (common), 200/220/240 VAC (common) (See note.) 50/60 Hz (common)
Operating voltage range	90% to 110% of rated supply voltage
Power consumption	Approx. 2 VA
Input	Thermocouple (with sensor burnout detection circuit), platinum resistance thermometer, or thermistor
Control mode	ON/OFF or P control
Setting method	Analog setting
Indication method	No indication
Control output	Relay output: SPDT, 3 A at 250 VAC, resistive load (switching capacity: 330 VA)

Note: Specify either 100/110/120 VAC or 200/220/240 VAC when ordering.

## ■ Input Ranges

Input		Thermocouple		Platinum resistance thermometer	Thermistor (see note 2)
		K (CA) Chromel vs. alumel	L (IC) Iron vs. constantan	Pt100	THE
Range	°C	0 to 200 (5), 0 to 300 (10), 0 to 400 (10), 0 to 600 (20), 0 to 800 (20), 0 to 1,000 (25), 0 to 1,200 (25)	0 to 200 (5), 0 to 300 (10), 0 to 400 (10)	-50 to 50 (2), -20 to 80 (2), 0 to 50 (1), 0 to 100 (2), 0 to 200 (5), 0 to 300 (10), 0 to 400 (10)	-50 to 50 (2) (6 kΩ at 0°C), 0 to 100 (2) (6 kΩ at 0°C), 50 to 150 (2) (30 kΩ at 0°C)
	°F	32 to 392 (10), 32 to 572 (20), 32 to 752 (20), 32 to 1,112 (40), 32 to 1,472 (50), 32 to 1,832 (50), 32 to 2,192 (50)	32 to 392 (10), 32 to 572 (20), 32 to 752 (20)	32 to 212 (5), 32 to 392 (10)	---

Note: 1. Values in ( ) are the minimum unit.  
2. Values in ( ) are the thermistor resistive value.

## ■ Characteristics

Setting accuracy	±2% FS max.
Hysteresis	Approx. 0.5% FS (fixed)
Proportional band	3% FS (fixed)
Control period	Approx. 20 s
Reset range (see note 1)	5 ±1% FS min.
Insulation resistance	20 MΩ min. (at 500 VDC)
Dielectric strength	2,000 VAC, 50/60 Hz for 1 min between charged terminals and uncharged metallic parts
Vibration resistance	Malfunction: 10 to 55 Hz, 0.15-mm single amplitude for 10 min each in X, Y, and Z directions Destruction: 16.7 Hz, 2-mm double amplitude for 2 hrs each in X, Y, and Z directions
Shock resistance	Malfunction: 147 m/s <sup>2</sup> , 3 times each in 6 directions Destruction: 294 m/s <sup>2</sup> , 3 times each in 6 directions
Life expectancy	Electrical: 100,000 operations min. (3 A at 110 VAC, resistive load)
Ambient temperature	Operating: -10°C to 55°C (with no icing or condensation)
Ambient humidity	Operating: 45% to 85%
Degree of protection	Front panel: IEC standard IP40 (see note 2) Terminals: IEC standard IP00
Weight	Approx. 200 g (with flush-mounting adapter)

Note: 1. No reset function is incorporated by any E5C2 model with ON/OFF control.  
2. The model number of the special watertight cover conforming to IP66, NEMA4 is Y92A-48B.

# Nomenclature

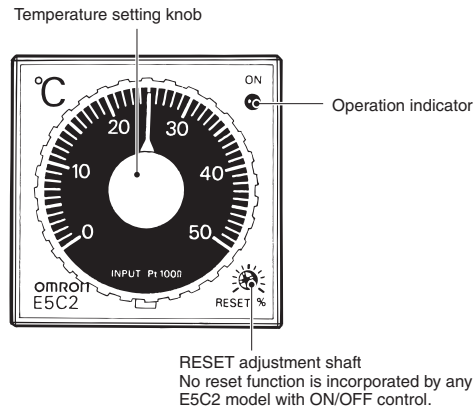

## Operation Indicator

Indicator	Output
Red Lit	ON
Not lit	OFF

## Dimensions

Note: All units are in millimeters unless otherwise indicated.

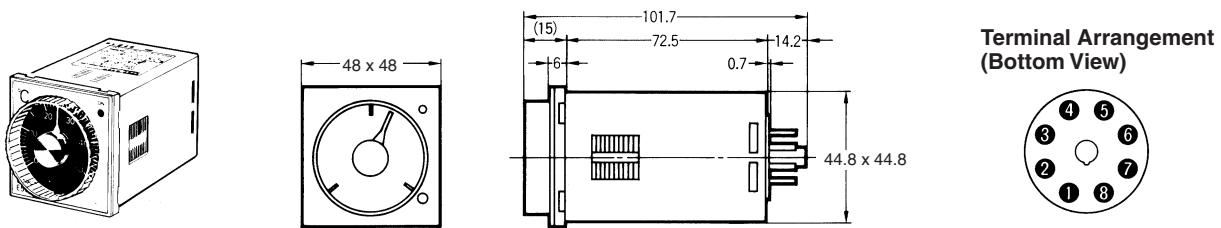

### Dimensions with Flush-mounting Adapter (Accessory), and Back Connecting Socket (Sold Separately)

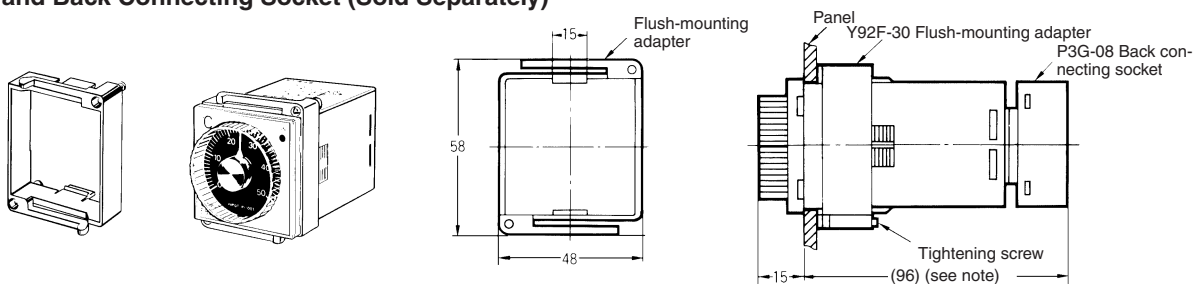

#### Panel Cutout

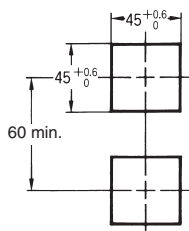

#### Side-by-side Mounting of N Controllers

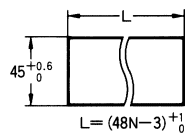

N	2	3	4	5	6
L	93 <sup>+1</sup> <sub>0</sub>	141 <sup>+1</sup> <sub>0</sub>	189 <sup>+1</sup> <sub>0</sub>	237 <sup>+1</sup> <sub>0</sub>	285 <sup>+1</sup> <sub>0</sub>

- Note: 1. Recommended panel thickness is 1 to 4 mm.  
2. Close side-by-side mounting is possible (in a single direction).

Temperature Controller

## Accessories (Order Separately)

### P2CF-08 Front Connecting Socket

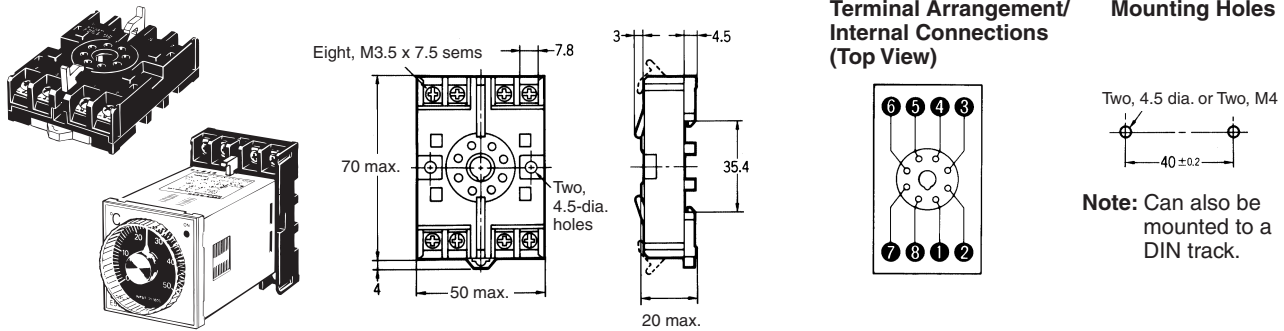

**Note:** A finger-protection model (P2CF-08-E) is also available.

### P3G-08 Back Connecting Socket (for Flush Mounting)

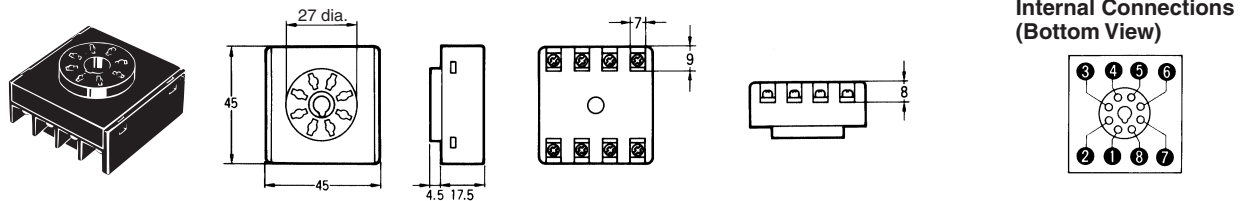

**Note:** A Protective Cover for finger protection (Y92A-48G) is also available.

### Protective Cover Y92A-48

The protective cover protects the front panel, particularly the setting section, against dust, dirt, and water drip. It also prevents the set values from being altered due to accidental contact with the setting keys.

<b>Appearance</b>	
<b>Model</b>	Y92A-48B

## Installation

### Connections

#### Input

Connect a thermocouple, the E52-THE□ Thermistor or platinum resistance thermometer to the E5C2 as shown in the following illustration.

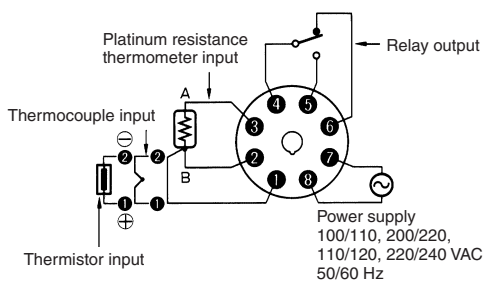

#### Output

If the load circuit is a heating control system, be sure to connect the load to terminals 4 and 5. If the load circuit is a cooling control system, be sure to connect the load to terminals 4 and 6. If the heating control system is connected to terminals 4 and 6 or the cooling control system is connected to terminals 4 and 5, the temperature of the heating control system or cooling control system will be abnormal and a serious accident may result.

If the E5C2 is in frequent operation, such as proportional operation, add an appropriate external relay to the E5C2 by considering the capacity of the load and the life of the relay.

#### Power Supply

If a single power supply is used for the E5C2 and the load, the supply voltage of the power supply may vary greatly when the load is open or closed if the capacity of the power supply is not large enough. Make sure that the capacity of the power supply is large enough so that the supply voltage range will be always from 90% to 110% of the rated supply voltage.

The E5C2 operates at either 50 or 60 Hz.

# Precautions

## Mounting

### Track Mounting (E5C2 with P2CF-08)

When mounting two or more E5C2 models with track-mounting sockets, leave a space of approximately 20 mm on both sides of the sockets where hooks are located.

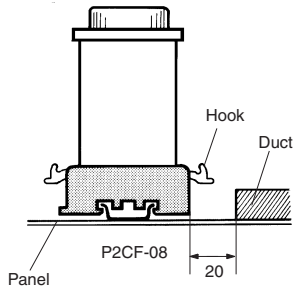

### Flush Mounting

Insert E5C2 into the square hole of the panel and insert an adapter from the back so that there will be no space between E5C2 and the panel. Then, secure the E5C2 with a screw.

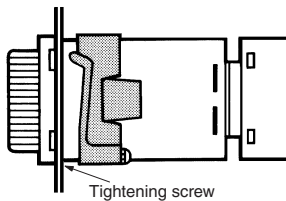

The P3G-08 can be wired in the same way as the P2CF-08.

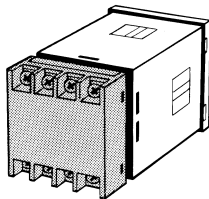

### Dismounting

If flush mounted, loosen the screw of the adapter and disengage the hooks for dismounting.

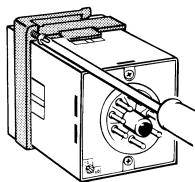

### Temperature Setting

Do not turn the temperature setting knob of the E5C2 with excessive force, otherwise the stopper of the knob may break.

### Others

Do not remove the housing of the E5C2, otherwise the housing may break.

To clean the surface of the E5C2, use a soft cloth wet with neutral detergent or alcohol. Do not use any organic solvent, such as paint thinner or benzene, strong acid or strong alkali to clean the surface of the E5C2, otherwise the surface of the E5C2 will become damaged.

ALL DIMENSIONS SHOWN ARE IN MILLIMETERS.

To convert millimeters into inches, multiply by 0.03937. To convert grams into ounces, multiply by 0.03527.

Cat. No. H081-E1-02

In the interest of product improvement, specifications are subject to change without notice.