

Parameter	Ratings	Units
Blocking Voltage	250	V <sub>P</sub>
Load Current	170	mA
Max R <sub>ON</sub>	20	Ω

### Features

- 3750V<sub>rms</sub> Input/Output Isolation
- Low Drive Power Requirements (TTL/CMOS Compatible)
- No Moving Parts
- High Reliability
- Arc-Free With No Snubbing Circuits
- FCC Compatible
- VDE Compatible
- No EMI/RFI Generation
- Small 8-Pin Package
- Machine Insertable, Wave Solderable
- Surface Mount and Tape & Reel Versions Available

### Applications

- Telecommunications
  - Telecom Switching
  - Tip/Ring Circuits
  - Modem Switching (Laptop, Notebook, Pocket Size)
  - Hook Switch
  - Dial Pulsing
  - Ground Start
  - Ringing Injection
- Instrumentation
  - Multiplexers
  - Data Acquisition
  - Electronic Switching
  - I/O Subsystems
  - Meters (Watt-Hour, Water, Gas)
- Medical Equipment-Patient/Equipment Isolation
- Security
- Aerospace
- Industrial Controls

### Description

LAA120 is a Dual 1-Form-A Solid State Relay that has two independently controlled, optically coupled MOSFET switches. The MOSFET switches and photovoltaic die use Clare's patented OptoMOS architecture to provide 3750V<sub>rms</sub> of input to output isolation. The optically coupled outputs are controlled by highly efficient GaAIAs infrared LEDs. This dual switch OptoMOS relay provides a more compact design solution than discrete single-pole relays in a variety of applications, and saves board space by incorporating both switches in a single 8-pin package.

### Approvals

- UL Certified Component: File E76270
- CSA Certified Component: Certificate 1175739
- EN/IEC 60950-1 Certified Component: TUV Certificate B 10 05 49410 006

### Ordering Information

Part #	Description
LAA120	8-Pin DIP (50/Tube)
LAA120S	8-Pin Surface Mount (50/Tube)
LAA120STR	8-Pin Surface Mount (1,000/Reel)
LAA120P	8-Pin Flat Pack (50/Tube)
LAA120PTR	8-Pin Flat Pack (1,000/Reel)

### Pin Configuration

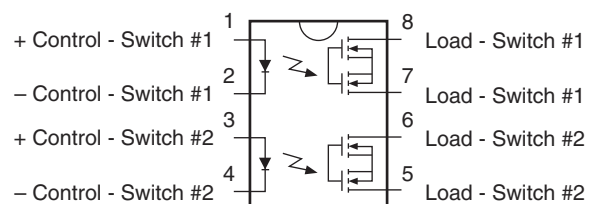

Switching Characteristics of Normally Open (Form A) Devices

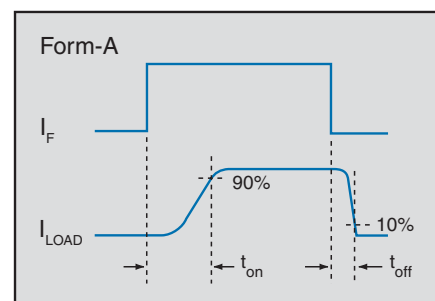

## Absolute Maximum Ratings @ 25°C

Parameter	Ratings	Units
Blocking Voltage	250	$V_P$
Reverse Input Voltage	5	V
Input Control Current	50	mA
Peak (10ms)	1	A
Input Power Dissipation <sup>1</sup>	150	mW
Total Power Dissipation <sup>2</sup>	800	mW
Isolation Voltage, Input to Output	3750	$V_{rms}$
Operational Temperature	-40 to +85	°C
Storage Temperature	-40 to +125	°C

<sup>1</sup> Derate linearly 1.33 mW / °C

<sup>2</sup> Derate linearly 6.67 mW / °C

*Absolute Maximum Ratings are stress ratings. Stresses in excess of these ratings can cause permanent damage to the device. Functional operation of the device at conditions beyond those indicated in the operational sections of this data sheet is not implied.*

## Electrical Characteristics @ 25°C

Parameter	Conditions	Symbol	Min	Typ	Max	Units
<b>Output Characteristics</b>						
Load Current						
Continuous <sup>1</sup>	-	$I_L$	-	-	170	mA
Peak	t = 10ms	$I_{LPK}$	-	-	400	
On-Resistance <sup>2</sup>	$I_L=170mA$	$R_{ON}$	-	15	20	$\Omega$
Off-State Leakage Current	$V_L=250V_P$	$I_{LEAK}$	-	-	1	$\mu A$
Switching Speeds						
Turn-On	$I_F=5mA, V_L=10V$	$t_{on}$	-	-	5	ms
Turn-Off		$t_{off}$	-	-	5	
Output Capacitance	$V_L=50V, f=1MHz$	$C_{OUT}$	-	50	-	pF
<b>Input Characteristics</b>						
Input Control Current	$I_L=170mA$	$I_F$	-	-	5	mA
Input Dropout Current	-	-	0.4	0.7	-	mA
Input Voltage Drop	$I_F=5mA$	$V_F$	0.9	1.2	1.4	V
Reverse Input Current	$V_R=5V$	$I_R$	-	-	10	$\mu A$
<b>Common Characteristics</b>						
Input to Output Capacitance	-	$C_{IO}$	-	3	-	pF

<sup>1</sup> If both poles operate, then the load current must be derated so that it does not exceed the package power dissipation value.

<sup>2</sup> Measurement taken within 1 second of on-time.

**PERFORMANCE DATA \***

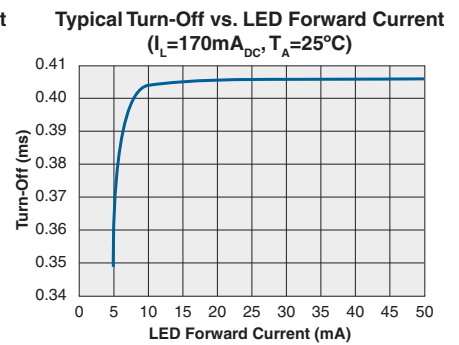
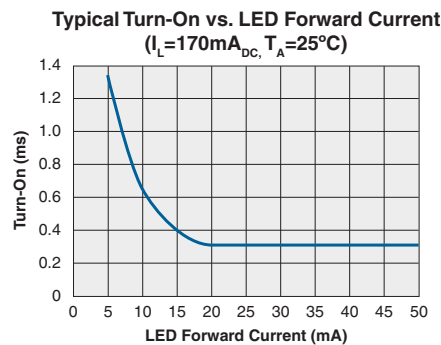
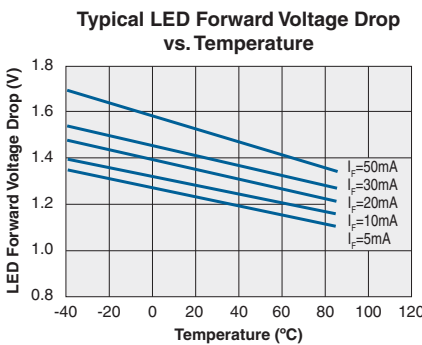
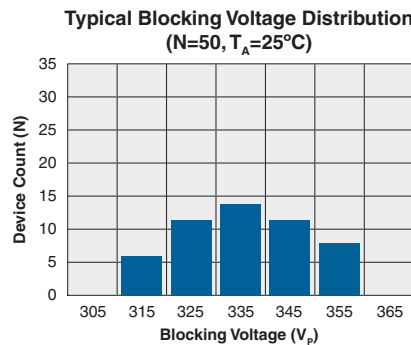
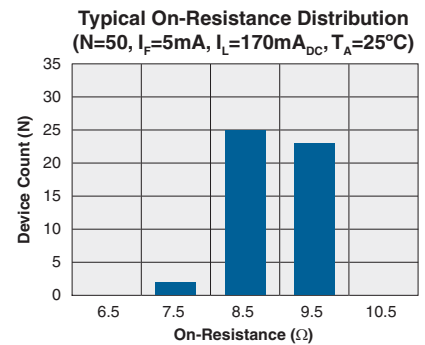
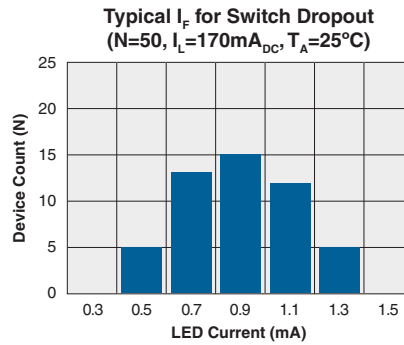
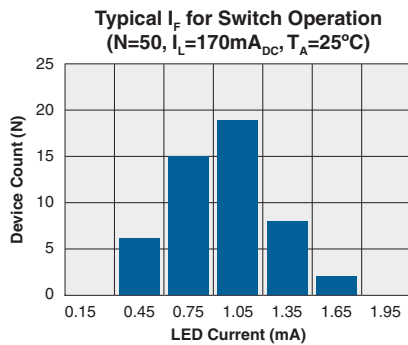
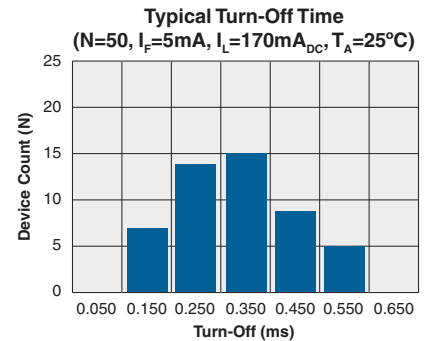
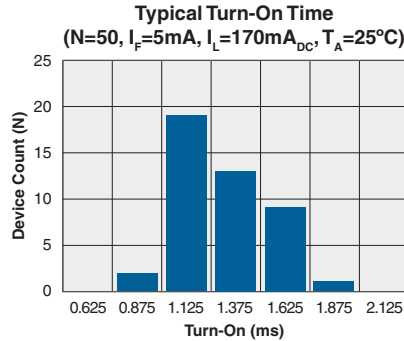
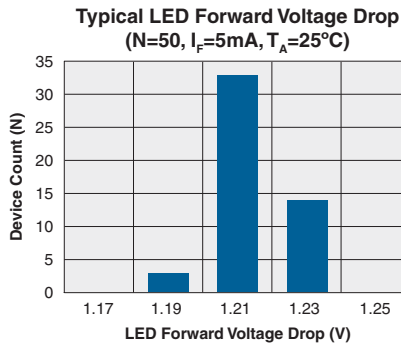

\*The Performance data shown in the graphs above is typical of device performance. For guaranteed parameters not indicated in the written specifications, please contact our application department.

**PERFORMANCE DATA\***

**Typical On-Resistance vs. Temperature**  
( $I_F=5mA$ ,  $I_L=170mA_{DC}$ )

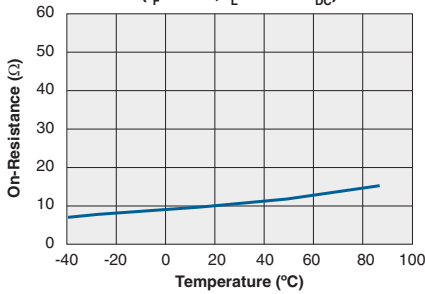

**Typical Turn-On vs. Temperature**  
( $I_L=170mA_{DC}$ )

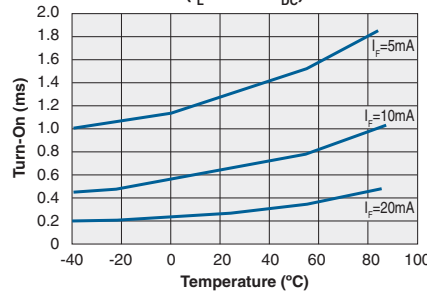

**Typical Turn-Off vs. Temperature**  
( $I_L=170mA_{DC}$ )

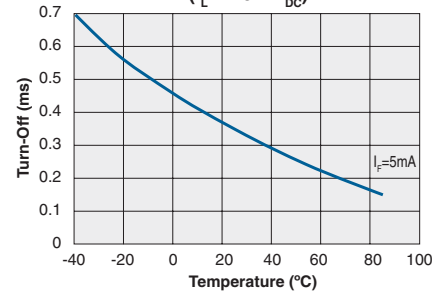

**Typical  $I_F$  for Switch Operation vs. Temperature**  
( $I_L=170mA_{DC}$ )

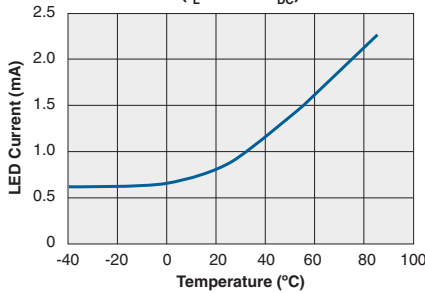

**Typical  $I_F$  for Switch Dropout vs. Temperature**  
( $I_F=170mA_{DC}$ )

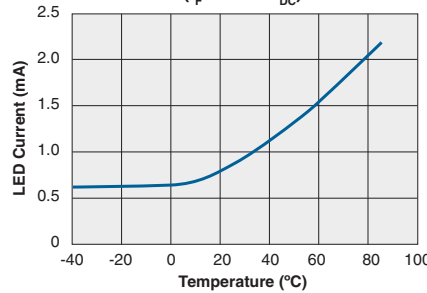

**Typical Load Current vs. Temperature**

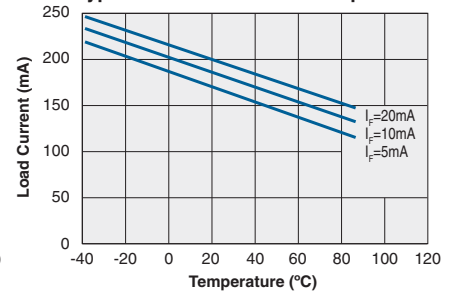

**Typical Load Voltage vs. Load Current**  
( $I_F=5mA$ ,  $T_A=25°C$ )

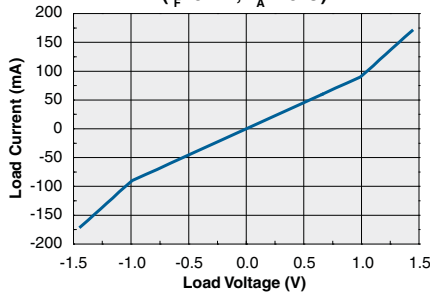

**Typical Blocking Voltage vs. Temperature**

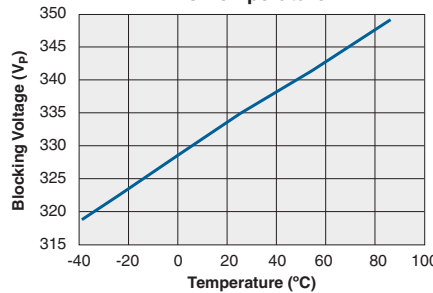

**Typical Leakage vs. Temperature Measured across Pins 5&6 or 7&8**  
( $V_L=250V$ )

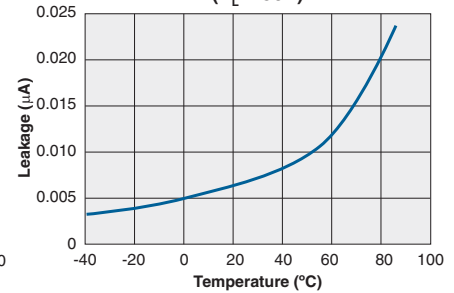

**Energy Rating Curve**

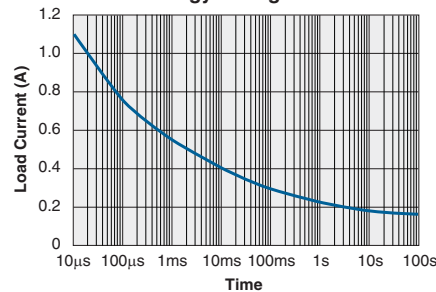

\*The Performance data shown in the graphs above is typical of device performance. For guaranteed parameters not indicated in the written specifications, please contact our application department.

## Manufacturing Information

### Moisture Sensitivity



All plastic encapsulated semiconductor packages are susceptible to moisture ingress. Clare classified all of its plastic encapsulated devices for moisture sensitivity according to the latest version of the joint industry standard, **IPC/JEDEC J-STD-020**, in force at the time of product evaluation. We test all of our products to the maximum conditions set forth in the standard, and guarantee proper operation of our devices when handled according to the limitations and information in that standard as well as to any limitations set forth in the information or standards referenced below.

Failure to adhere to the warnings or limitations as established by the listed specifications could result in reduced product performance, reduction of operable life, and/or reduction of overall reliability.

This product carries a **Moisture Sensitivity Level (MSL) rating** as shown below, and should be handled according to the requirements of the latest version of the joint industry standard **IPC/JEDEC J-STD-033**.

Device	Moisture Sensitivity Level (MSL) Rating
LAA120 / LAA120S / LAA120P	MSL 1

### ESD Sensitivity



This product is **ESD Sensitive**, and should be handled according to the industry standard **JESD-625**.

### Reflow Profile

This product has a maximum body temperature and time rating as shown below. All other guidelines of **J-STD-020** must be observed.

Device	Maximum Temperature x Time
LAA120 / LAA120S	250°C for 30 seconds
LAA120P	260°C for 30 seconds

### Board Wash

Clare recommends the use of no-clean flux formulations. However, board washing to remove flux residue is acceptable. Since Clare employs the use of silicone coating as an optical waveguide in many of its optically isolated products, the use of a short drying bake may be necessary if a wash is used after solder reflow processes. Chlorine-based or Fluorine-based solvents or fluxes should not be used. Cleaning methods that employ ultrasonic energy should not be used.



**MECHANICAL DIMENSIONS**

**LAA120**

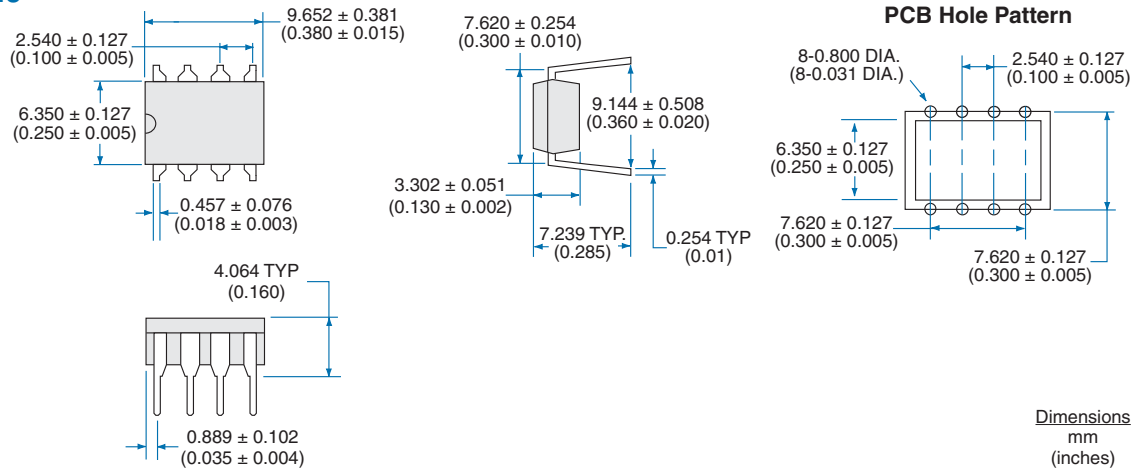

**LAA120S**

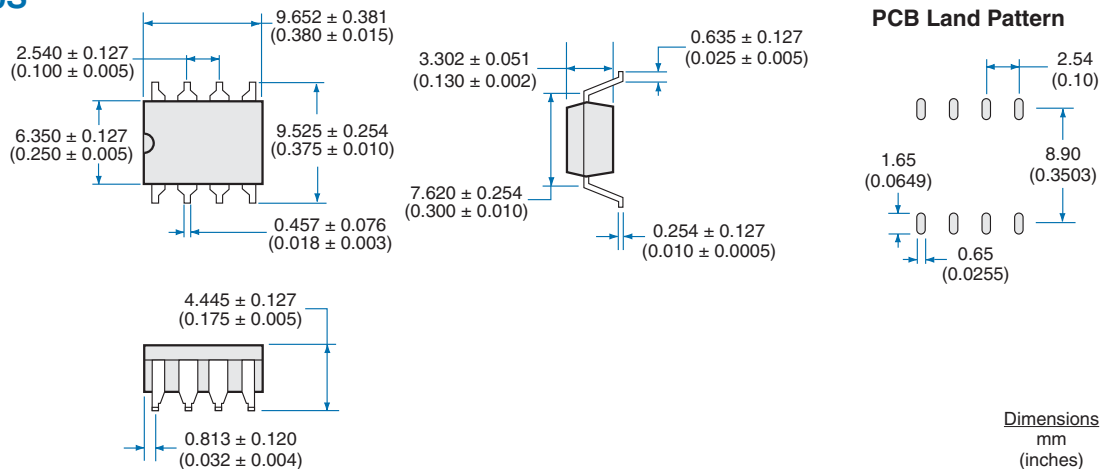

**LAA120P**

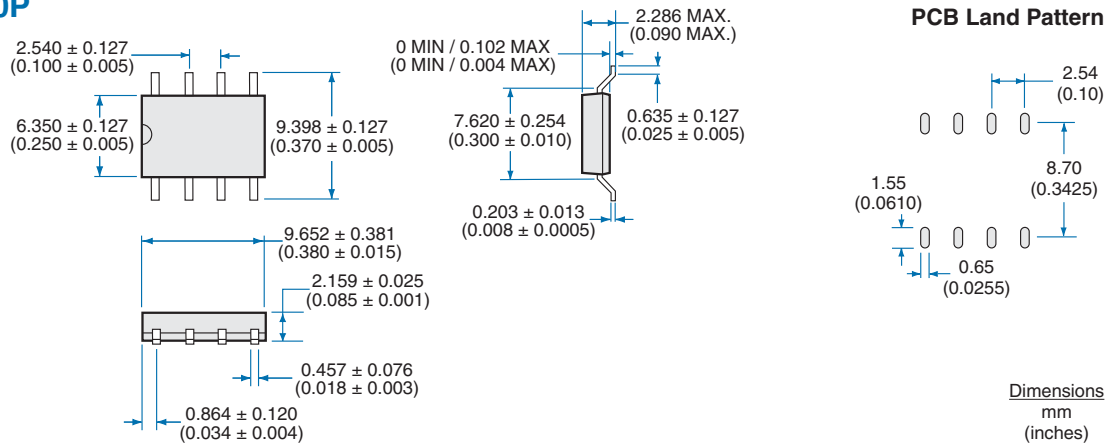

**MECHANICAL DIMENSIONS**

**LAA120S Tape & Reel**

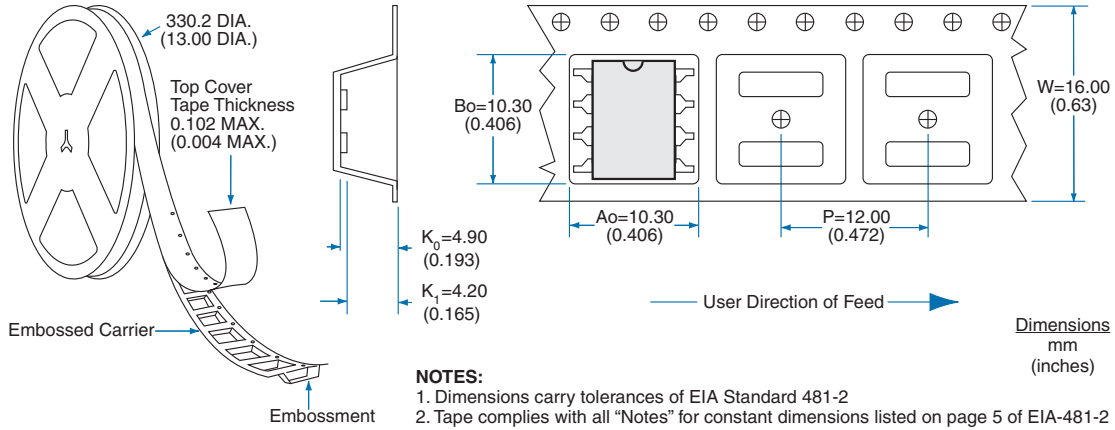

**LAA120P Tape & Reel**

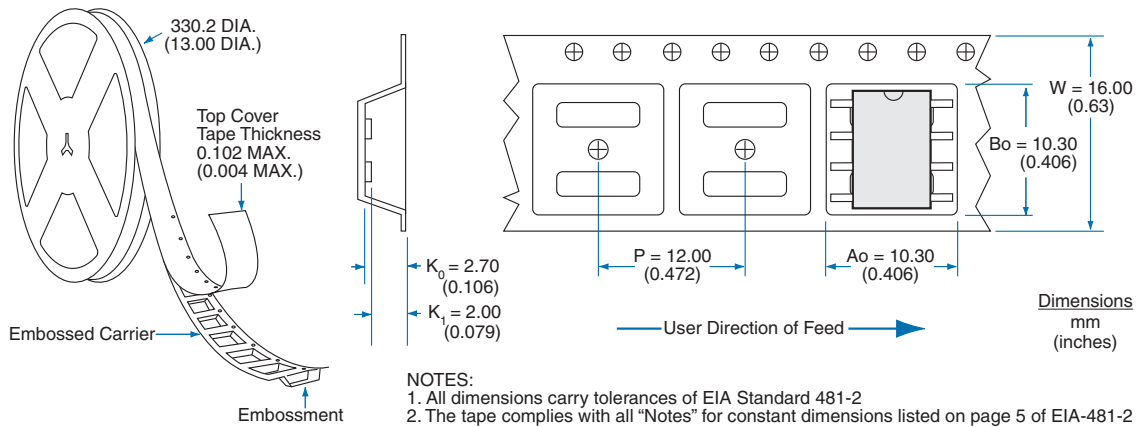

For additional information please visit our website at: [www.clare.com](http://www.clare.com)

Clare, Inc. makes no representations or warranties with respect to the accuracy or completeness of the contents of this publication and reserves the right to make changes to specifications and product descriptions at any time without notice. Neither circuit patent licenses nor indemnity are expressed or implied. Except as set forth in Clare's Standard Terms and Conditions of Sale, Clare, Inc. assumes no liability whatsoever, and disclaims any express or implied warranty, relating to its products including, but not limited to, the implied warranty of merchantability, fitness for a particular purpose, or infringement of any intellectual property right.

The products described in this document are not designed, intended, authorized or warranted for use as components in systems intended for surgical implant into the body, or in other applications intended to support or sustain life, or where malfunction of Clare's product may result in direct physical harm, injury, or death to a person or severe property or environmental damage. Clare, Inc. reserves the right to discontinue or make changes to its products at any time without notice.