

Miniature Power Relays Series M15

Type M15 . . . 100/001

Monostable



- Miniature size 15 mm high
- PCB mounting
- 4 kV / 8 mm insulation
- Switching capability 8 A / 250 VAC
- DC coils 2 to 147 VDC
- General purpose, industrial electronics
- Sealed according IP 67 standard
- 4 different pin layout configurations
- Low coil power consumption

Product Description

Miniature sealed relay according to IP 67. Suitable for automatic soldering. Produced on fully automated production line.

Space saving design for compact packages. Very low contact noise due to short bounce time (NO contact)

Ordering Key M15 M A H 001 8 24VDC

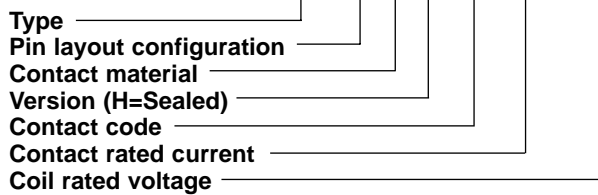

Pin layout configuration
M = 3.5 mm
B = 5.0 mm
F = 2.5 mm
E = 3.2 mm / 5.0 mm

Contact material
A = Ag CdO
B = Ag Ni
C = Ag CdO, Au plated
D = Ag CdO, gilded
E = AgNi, Au plated
F = Ag, gilded
S = Ag SnO₂

Type Selection

Contact configuration	Contact rating	Contact code
1 normally open contact (SPST-NO {1-form A})	8 A	100
1 change over contact (SPDT-CO {1-form C})	8 A	001

Coil Characteristics, DC (20 °C)

Rated voltage VDC	Winding resistance Ω ± 10%	Operating range		Drop out voltage ≥ VDC
		Min. VDC	Max. VDC	
3.0	40	2.00	5.3	0.150
5.0	115	3.40	9.0	0.250
6.0	160	4.00	10.6	0.300
8.0	290	5.40	14.2	0.400
12.0	640	8.40	21.2	0.600
18.0	1450	12.60	31.9	0.900
24.0	2550	16.00	42.2	1.200
48.0	10250	33.50	84.7	2.400
110.0	31000	73.01	147.0	5.500

Temperature Influence

Operating voltages for step excitation. Minimum operating voltage is referred to +20 °C/+68 °F ambient temperature; maximum operating voltage is referred to +40 °C/+104 °F ambient temperature.

t °C	t °F	K1	K2
0	32	0.92	1.15
10	50	0.96	1.12
20	68	1.00	1.09
30	86	1.04	1.05
40	104	1.08	1.00
50	122	1.12	0.94
60	140	1.16	0.88
70	158	1.20	0.81

Values of minimum and maximum operating voltage in respect to ambient temperature (t) may be obtained applying following formulas:

$$V_{\min t} = K1 \cdot V_{\min 20}$$

$$V_{\max t} = K2 \cdot V_{\max 40}$$

Contact Characteristics

Rating	8 A
Material (standard version) ¹⁾	Ag CdO
Current (for AC)	
Rated current	8 A
Max. switching current	10 A
Voltage	
Rated voltage	250 VAC - 50 Hz
Max. switching voltage	440 VAC (max 1500 VA)
Max. switching voltage (VDE 0435)	380 VAC
Power	
Max. switch. power with resistive load in AC	2000 VA
Max. switch. power with resistive load in DC	See diagram 1
Min. switching current ³⁾	100 mA at 24 VDC
Life	
Expected life at:	
8 A-250 VAC - cos φ = 1	100000 cycles
5 A-250 VAC - cos φ = 0.4	100000 cycles
Mechan. life at max. switching frequency of 18.000 cycles/h	30 x 10 ⁶ cycles

General Data

Operating time at rated voltage	≤ 9 ms
Operating bounce time	≤ 1 ms
Release time	≤ 3 ms
Release bounce time	≤ 3 ms
Ambient temperature ²⁾	- 40 °C to +70 °C
Vibration resistance	2,5 mm p.p. 5 ÷ 45 Hz 10 G, 45 ÷ 100 Hz
Shock resistance	10 G, 11 ms
Inside protection according to IEC 144	IP 67 sealed
Weight	10 g
Working class/type of service	C / Continuous

¹⁾If required, the contacts can be supplied with flash gilded silver contacts for storage purpose (24 VDC/10mA), as well as with gold plated silver contacts for very low switching levels, in the range of 10 mA and 10 mV. AgNi contacts for DC loads and AgSnO₂ contacts for heavy loads are also available.

²⁾Supplying the relay coil at the maximum voltage given in the table "Temperature Influence", the maximum ambient temperature value decreases from 70° to 40°C.

³⁾Typical value

Insulation

Insulation Resistance at 500 VDC	2 x 10 ⁷ M Ω
Test voltage (1 min.)	
Open contacts	1000 VAC
Coil/Contacts	4000 VAC
Insulation group according to VDE 0110	
Contact/Coil IGR	C/660
Open/Contact IGR	C/250

Special loads - Motor loads

	AC1	(IEC 947-5)		Motor loads			
	250 VAC	AC 15 250 VAC	DC13 24 VDC	AgCdO		AgSnO ₂	
				115 VAC	250 VAC	115 VAC	250 VAC
M15 001	8A	2.5A	5A	1/8 HP	1/3 HP	1/3 HP	3/4 HP

Dimensions

Pin View

Wiring Diagrams

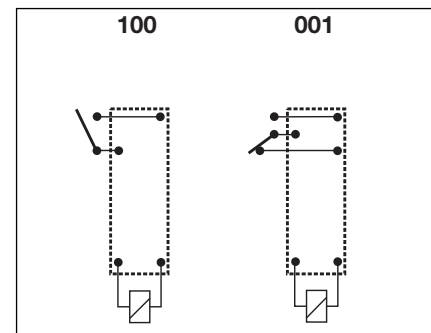
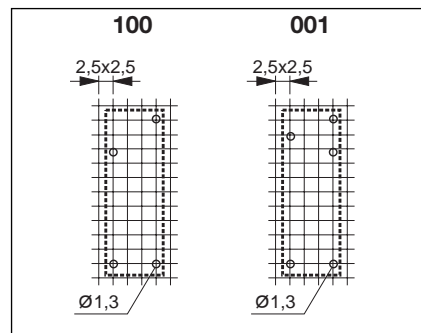
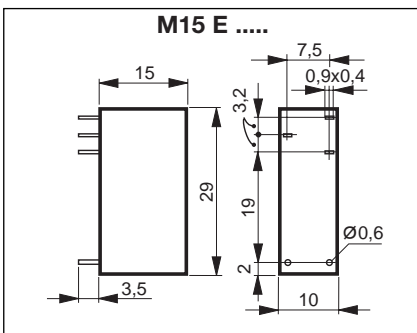
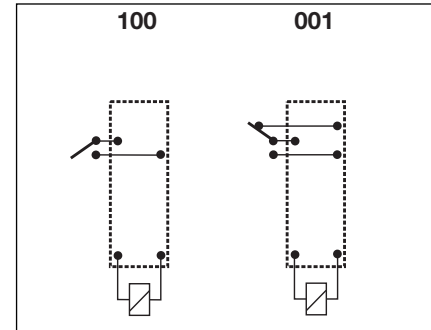
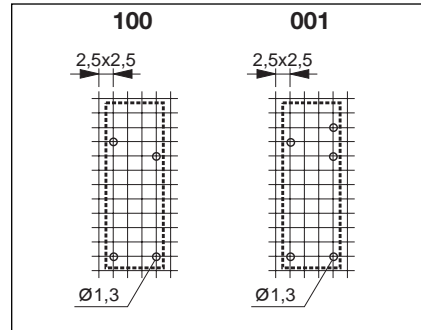
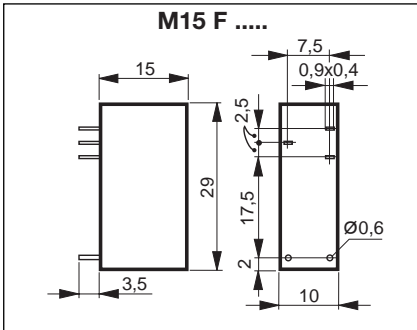
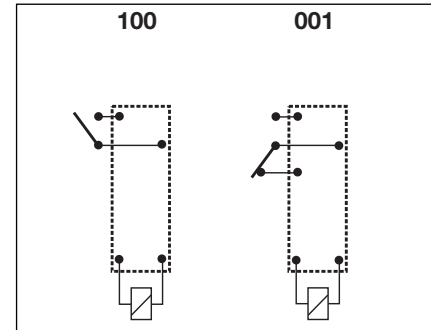
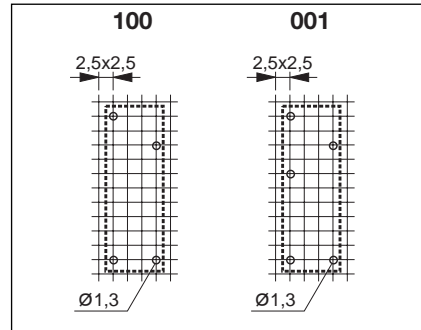
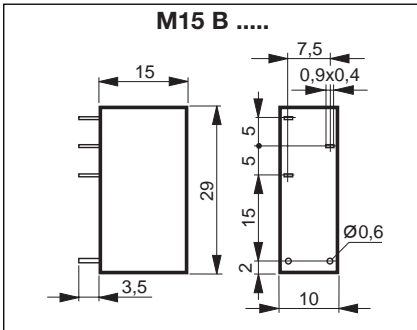
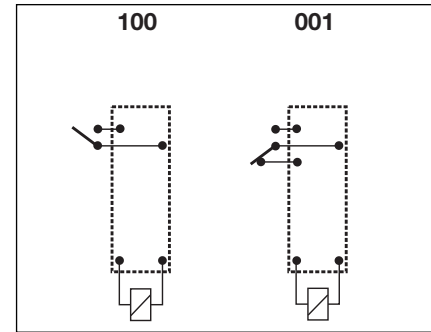
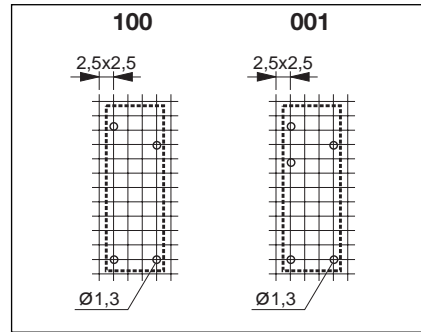
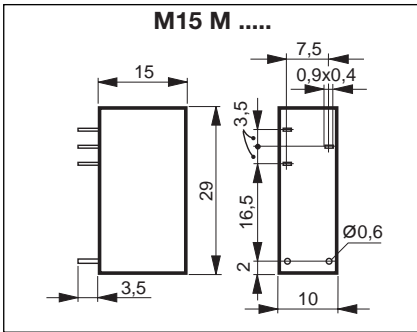

View from solder side.

Diagrams

1 Max. switching power DC

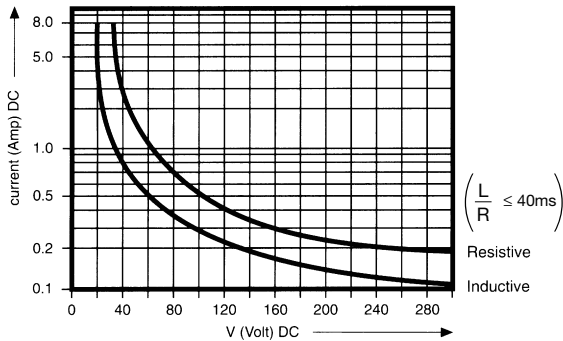

2 Expected switching cycles/switching current at 250 VAC. For resistive loads and repetition rate 360 cycles/h.

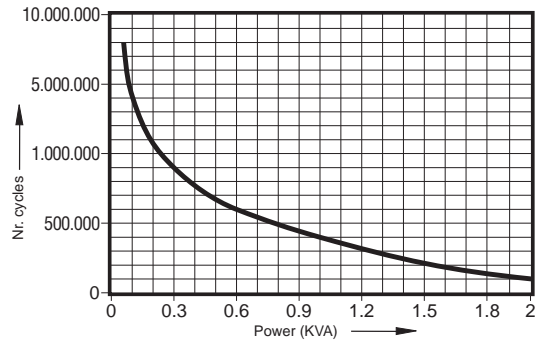

Diagrams

3 Reduction of expected life against load power factor $\cos \varphi$

For all types

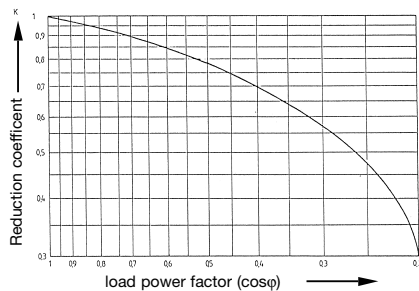

Application Hints

Use of sealed relays

The M15 relay types are completely sealed (according to IEC 68 part 2 - 17 {DIN 40046} QC 2 - test).

They are flux proof and are suited for automated soldering (wave soldering) as well as for immersion washing.

If maximum utilization of the switching capacity is required, it is recommended to open the relay after completion of the soldering/washing process by breaking out the corresponding pin as indicated.

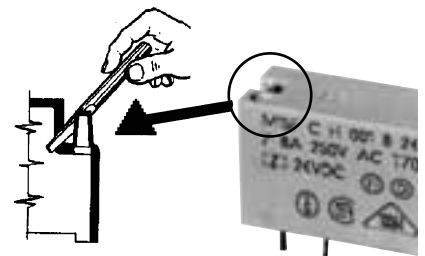

Product safety

Operations outside the stated ratings shown in this catalogue may result in a possible failure or unsafe operating conditions.

Approvals



ITALY



U.S.A.



CANADA



GERMANY



SWITZERLAND



SWEDEN



DENMARK



NORWAY



FINLAND

The approvals are not generally applicable to all relay versions of a particular type.

For further information please apply for relevant data sheets ref. **3.84.00.10.X**