

Special Load PCB Relay RP 3 SL

1 pole 16 A, for high inrush currents,
mono- or bistable



Features

- 1 N/O contact
- 120 A / 20 ms inrush peak current
- DC- or bistable version
- 4 kV / 8 mm coil-contact

Applications

Lighting control, timers, motor control, building automation



Technical data of approved types on request

F0147-A

Contact data

Configuration	1 N/O contact
Type of contact	single contact
Rated current	16 A
Rated voltage / max.breaking voltage AC	250 Vac / 440 Vac
Maximum breaking capacity AC	4000 VA
Make current (max. 4 s at duty cycle 10%)	25 A
Peak inrush current	120 A
Contact material	AgSnO ₂

Contact ratings

Type	Load	Operations	Standard
RP3SL	12 A, 250 Vac, cosφ=1	3x10 ⁵	
RP3SL	TV 8	25x10 ³	UL 508
RP3SL	2500 W, 230 Vac, halogen lamps	>10 ⁴	
RP3SL	1000 W, 250 Vac, incandescent lamps	2.3x10 ⁵	
RP3SL	3000 W, 250 Vac, incandescent lamps	3.6x10 ⁴	
RP3SL	1500 VA, fluorescent lamps 163 μF	10 ⁴	

Coil data monostable DC coil

Nominal voltage	5...110 Vdc
Nominal coil power	500 mW
Operate category	2 / b

Coil versions monostable DC coil

Coil code	Nominal voltage Vdc	Pull-in voltage Vdc	Release voltage Vdc	Maximum voltage Vdc	Coil resistance Ω	Coil current mA
012	12	9.0	1.2	21.6	270±10%	44.4
024	24	18.0	2.4	43.2	1100±15%	21.8
048	48	36.0	4.8	86.4	4400±15%	10.9
060	60	45.0	6.0	108.0	6540±15%	9.2

All figures are given for coil without preenergization, at ambient temperature +20°C
Other coil voltages on request

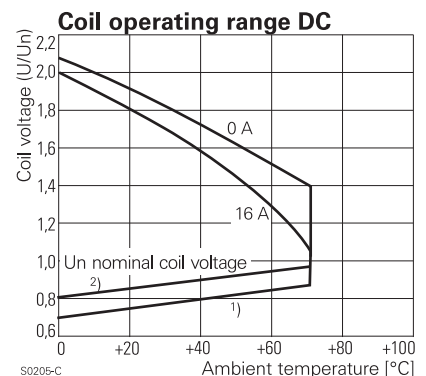
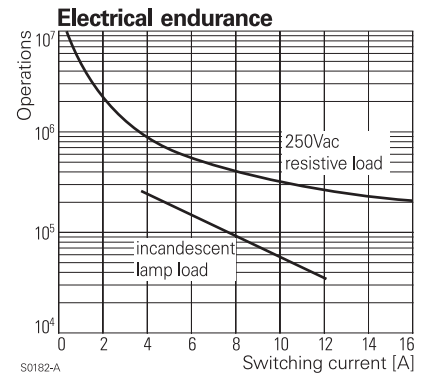
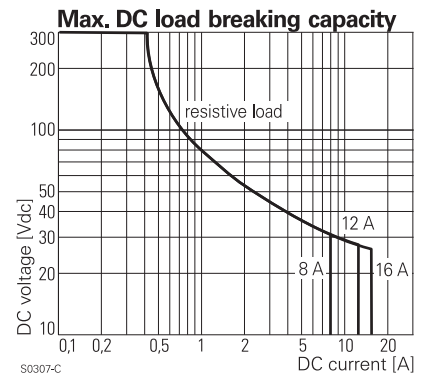

Special Load PCB Relay RP 3 SL

1 pole 16 A, for high inrush currents,
mono- or bistable

Coil data bistable	1 coil	2 coils
Nominal voltage	5...110 Vdc	5...60 Vdc
Nominal coil power	1.2...1.4 W	1.2...1.5 W
Minimum energization time	20 ms	
Reset voltage min.	70 % U_{nom}	75 % U_{nom}
Reset voltage max.	110 % U_{nom}	120 % U_{nom}

Coil versions bistable

Coil code	Nominal voltage Vdc	Pull-in voltage Vdc	Reset voltage Vdc	Reset R1 Ω / W	Coil resistance Ω	Coil current mA
bistable, 1 coil						
A05	5	3.7	3.6	39 / 0.5	21 \pm 10%	238.1
A12	12	9.0	8.7	220 / 0.5	115 \pm 10%	104.3
A24	24	18.0	16.7	820 / 0.5	460 \pm 10%	52.2
bistable, 2 coils						
F12	12	9.0	9.0		105 \pm 15%	114.3
F24	24	18.0	18.0		460 \pm 15%	52.2

All figures are given for coil without preenergization, at ambient temperature +20°C, duty cycle 20%

Other coil voltages on request

Insulation

Dielectric strength	coil-contacts	4000 V_{rms}
	open contact circuit	2000 V_{rms}
Clearance / creepage		8 / 8 mm
Insulation to IEC 60664		
	Voltage rating	250 V
	Pollution degree	3
	Overvoltage category	III
Insulation to VDE 0110b (2/79)		
	Insulation category / reference voltage	C / 250

Other data

Ambient temperature	-40...+70 °C	
Mechanical life	30x10 ⁶ operations	
Max. switching rate at rated- / minimum load	10 min ⁻¹ / 1200 min ⁻¹	
Operate- / release time monostable	typ. 8 / 2 ms	
Operate- / reset time bistable	typ. 6 / 2 ms	
Bounce time	typ. 2 ms	
Vibration resistance	20 g, 30...300 Hz	
Shock resistance (destruction)	100 g	
Protection category	RT II - flux proof, RT III - wash tight	
Relay weight	18 g	
Packaging unit	1 coil	20 / 500 pcs.
	2 coils	25 / 100 pcs.
Accessories	see accessories RP	

Coil operating range DC

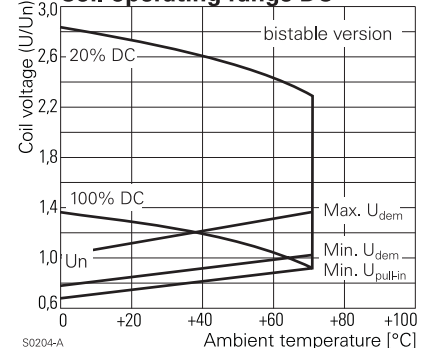

Circuit scheme for bistable 1 coil

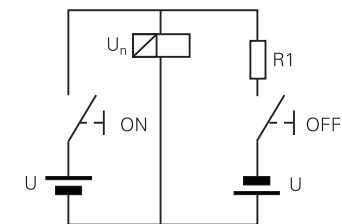

S0328-A

PCB layout / terminal assignment

View on solder pins
Dimensions in mm

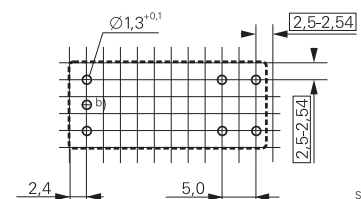

S0163-CR

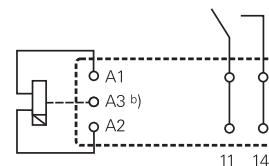

S0163-CS

Bistable versions:

Indicated contact position during or after coil energization with reset voltage.

2-coil versions:
Operate A2, A3
Reset A1, A3

b) for 2 coil version only

Special Load PCB Relay RP 3 SL

1 pole 16 A, for high inrush currents,
mono- or bistable

Dimensions

Dimensions in mm

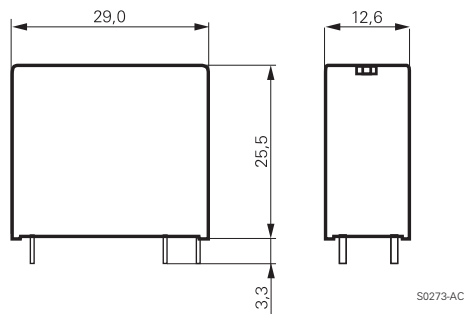

Product key

Type	R	P		S	L		
Version	3 flux proof						
Contacts / contact material	7 wash tight						
Coil	SL 1 N/O contact, AgSnO ₂						
Coil code: please refer to coil versions table							

Preferred types in bold print

Product key	Version	Contacts	Coil	Coil	Part number
RP3SL005	16 A	1 N/O contact	DC-coil	5 Vdc	0-1393230-7
RP3SL012	flux proof	AgSnO		12 Vdc	0-1393230-9
RP3SL024				24 Vdc	1-1393230-1
RP3SLA12			bistable	12 Vdc	0-1393230-3
RP3SLA24			1-coil	24 Vdc	0-1393230-4
RP3SLF12			bistable	12 Vdc	0-1393230-5
RP3SLF24			2-coils	24 Vdc	0-1393230-6
RP7SL012	16 A		DC-coil	12 Vdc	6-1393231-5
RP7SL024	wash tight			24 Vdc	6-1393231-6