

DC SUBMINIATURE SWITCH

DC subminiature switch

Sealed switch IP67 protection

- Models available for 120°C operating temperature
- Nominal currents from 10A at 250 V AC
- Various auxiliary actuators available (can also be retrofitted)
- Various application-specific contact materials
- Mechanical operating life min. 1,000,000 operations
- Various terminal types available



Technical specifications

Series	DC ❶
Contact configuration	S.P.D.T., S.P.S.T. - N.O., S.P.S.T. - N.C.
Contact gap	< 3 mm (μ)
Switching voltage (max.)	250 VAC
Switching current	0.1 to 10 A AC (see table on page 24) depending on model
Operating voltage	200 to 340 cN without auxiliary actuator, depending on model
Total travel	Approx. 1.6 mm
Mechanical life	(see table on page 23)
Electrical life	(see table on page 23)
Ambient temperature	-40 to +85°C/120°C
Model with leads	-40 to +105°C
Proof tracking index	PTI175, PTI250 on request

Materials

Cover	PBT (UL 94V-0), PET (UL 94V-0)
Actuator	POM UL 94 HB (T85), PBT UL 94 V-0 (T120)
Base	PET (UL 94V-0)
Contacts	AgNi/AuAgPt (Crosspoint)
Terminals	CuZn silver-plated
Auxiliary actuator	Stainless steel or Plastic
Sealing gasket	VMQ
Leads	Cu, PVC-sheathed
Approvals	depending on model

Degree of protection IP67
Switch interior

Circuitry ❸

Operating temperature +85°C	Code
S.P.S.T. - N.O.	E
S.P.S.T. - N.C.	F
S.P.D.T.	G
Operating temperature 120°C (with leads 105°C)	
S.P.S.T. - N.O.	A
S.P.S.T. - N.C.	B
S.P.D.T.	C

Terminal type ❹

Model	Code
Solder terminal short*	A1
PCB terminal 1.3 x 0.5 mm, straight*	H1
PCB terminal 0.6 x 0.5 mm, straight*	K1
PCB terminal 0.6 x 0.5 mm RH side**	K8
PCB terminal 0.6 x 0.5 mm LH side**	K9
PCB terminal 0.6 x 0.5 mm RH side***	K6
PCB terminal 0.6 x 0.5 mm LH side***	K7
Q.C. terminal 2.8 x 0.5 mm, straight*	L1
Leads 0.5 mm ² , routed downwards	B5
Leads 0.5 mm ² , with leads	B3
Leads 0.5 mm ² , on side opposite actuator	B4
Leads 0.75 mm ² , routed downwards	C5
Leads 0.75 mm ² , with leads	C3
Leads 0.75 mm ² , on side opposite actuator	C4
Without leads (Form B), on side opposite actuator/ on actuator side*	N3/N4
Without leads (Form A), on side opposite actuator/ on actuator side*	P3/P4
Without leads (no cut-out), with solder terminal*	Q5

* Max. 30° twisted ** with location pin *** W/o location pin

Electrical rating and operating life ❷

Electrical rating according to		Electrical life at rated load (operations)	Mechanical life	Operating force	Housing mark	Code
EN 61058-1	UL 1054	acc. to EN	acc. to UL	max. (cN)		
6 A 250 VAC	5 A 125-250 VAC	10,000	6,000	1 x 10 ⁶	200	DC 1
10 (1.5) A, 250 VAC	10.1 A, 125-250 VAC 1/4 HP, 125 VAC	10,000	6,000	1 x 10 ⁶	340	DC 2
0.1 A, 250 VAC	0.1 A 125-250 VAC	50,000	100,000	1 x 10 ⁶	200	DC 3
3 A, 250 VAC	3 A, 125-250 VAC	50,000	6,000	1 x 10 ⁶	200	DC 4*

* only possible as line version with line diameter 0.5 mm² and AWG 22

Auxiliary actuator ❺

Model	Length	Code
Without lever	-	AA
Straight	4.8	LB
	8	LC
	42	LD
Roller	2.5	RB
	4.7	RC
	39.7	RD
Simulated roller	2.5	SB
	4.7	SC
	39.7	SD
Plastic, straight	7	WB
	14	WC
Plastic roller	5.2	ZB
Plastic simulated roller	5.6	VB

Generation of order code (example)
 The order code consists of 5 parameters:

❶	❷	❸	❹	❺
Series	Electrical rating	Circuitry	Terminal type	Auxiliary actuator
DC = subminiature switch	1 = 6 A, 250 VAC	C = S.P.D.T.	A1 = Solder terminal short	LB = Lever straight, 4.8

- Not every configurable variant is available for order. Please contact us.
- The final two digits of article numbers on commercial documents refer to the index of the respective drawing.
- Customer-specific models are marked with a G or W as the sixth digit of the article number.



DC SUBMINIATURE SWITCH CONTINUED

Switching parameters

Model	Type	Max. operating force (cN)	Max. pretravel (mm)	Min. overtravel (mm)	Differential travel max. (mm)	Max. rest position (mm)	Operating point (mm)	Length actuator
Without auxiliary actuator	DC1, 3, 4	200	1.0	0.6	0.1	9.3	8.4 ± 0.3	-
	DC2	340	1.0	0.6	0.1	9.3	8.4 ± 0.3	

Electrical rating at DC voltage

Please see our technical specification for DC currents (TS-0002) which is available upon request.

Terminals

Solder terminal short max. 30° twisted

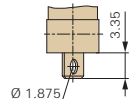

Q.C. terminal 2.8 x 0.5 mm max. 30° twisted

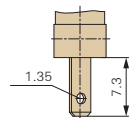

PCB terminal 1.3 x 0.5 mm max. 30° twisted

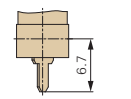

PCB terminal 0.6 x 0.5 mm max. 30° twisted



PCB terminal 0.6 x 0.5 mm RH side w/o location pin

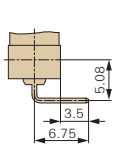

PCB terminal 0.6 x 0.5 mm RH side with location pin

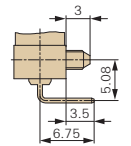

PCB terminal 0.6 x 0.5 mm LH side w/o location pins

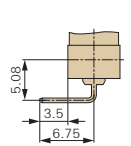

PCB terminal 0.6 x 0.5 mm LH side w/o location pins

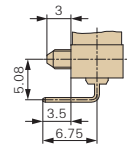

Side definition with terminals and location pins

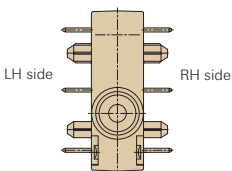

Drilling pattern for PCB terminal 1.3 x 0.5 mm

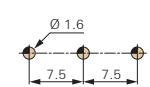

Dimensions in mm

Drilling pattern for PCB terminal 0.6 x 0.5 mm, straight/lateral

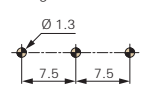

Drilling pattern for PCB terminal 0.6 x 0.5 mm, lateral with location pins

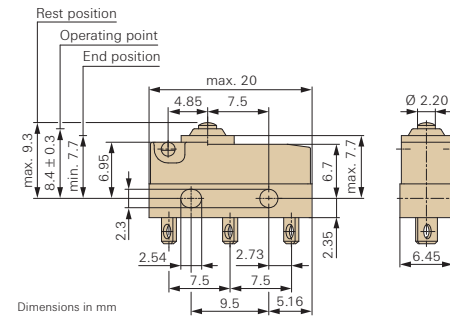
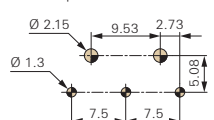

Dimensions in mm

Auxiliary actuator

Steel auxiliary actuator

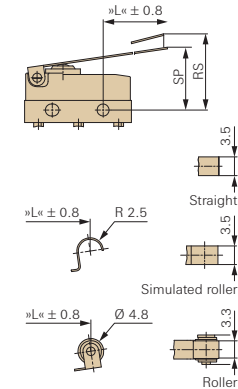

Plastic auxiliary actuator with/without adjusting screw

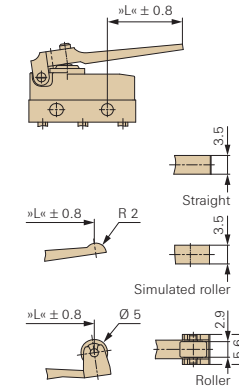

Model with connecting leads (IP67)

