

Tact Switches for SMT

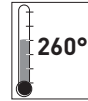

Specifications:

Contact rating:	12 V DC, 50 mA
Contact resistance:	< 100 mΩ
Insulation resistance:	> 100 MΩ at 500 V DC
Dielectric strength:	250 V, 50 Hz for the duration of 1 minute
Operating temperature:	- 25° to + 70° C
Electrical life:	2,6 N: minimum 100 000 cycles 1,6 N: minimum 200 000 cycles
Operating force:	see ordering code
Contacts:	phosphor bronze, silver-plated
Terminals:	brass, silver-plated
Material:	cover: stainless steel base and stem: high-temp. nylon meets UL 94 V-0; caps ABS
Mounting:	on pc-board – SMD
Soldering conditions:	hand-soldering – max.: 30 W, 2 sec, 320° C
Packaging:	on tapes – see ordering code
Travel:	0,35 mm + 0,2/- 0,1 mm

Models:

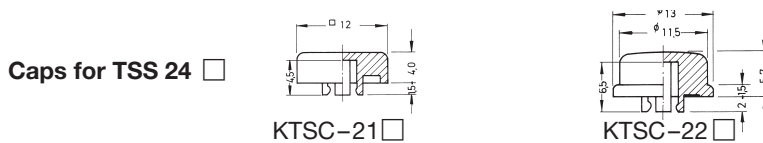
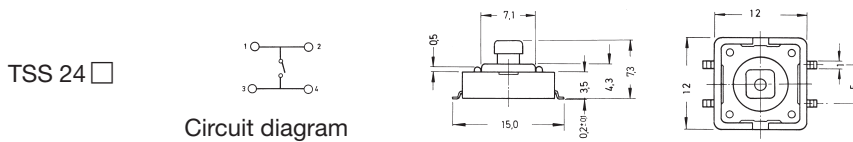
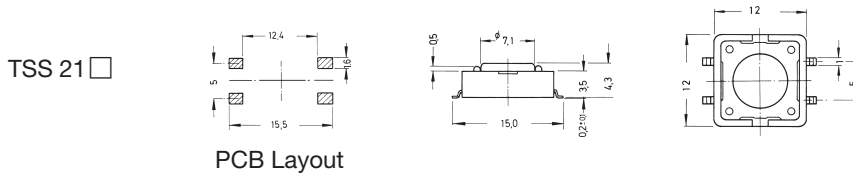

Ordering code:

Switches

TSS 2

Dimension / Packaging:

- 4,3 mm / 700 pcs/reel
- 7,3 mm / 500 pcs/reel

Colour of stem for operating force:

- 1,6 N, brown
- 2,6 N, red

Caps KTSC-2

Cap type:

- square
- round

Cap colour:

- yellow
- blue
- red
- ivory
- black
- green

Minimum quantity 5000 pcs



Tact Switches

Specifications:

Contact rating:	12 V DC, 50 mA
Contact resistance:	< 100 mΩ
Insulation resistance:	> 100 MΩ at 500 V DC
Dielectric strength:	250 V, 50 Hz for the duration of 1 minute
Operating temperature:	- 25° to + 70° C
Electrical life:	2,6 N: minimum 100 000 cycles 1,6 N: minimum 200 000 cycles
Operating force:	see ordering code
Contacts:	phosphor bronze, silver-plated
Terminals:	PC terminals, brass, silver-plated
Material:	cover: stainless steel base and stem: nylon meets UL 94 V-0
Mounting:	on pc-board
Soldering conditions:	hand-soldering – max.: 30 W, 2 sec, 320° C auto-soldering – max.: 5 sec, 260° C subject to PCB 1,6 mm thickness
Travel:	0,35 mm + 0,2/- 0,1 mm

Models:

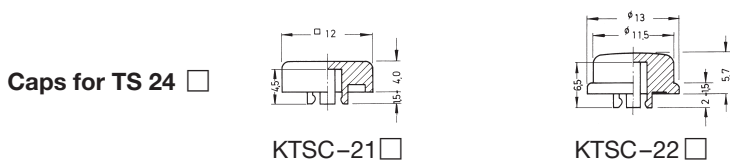
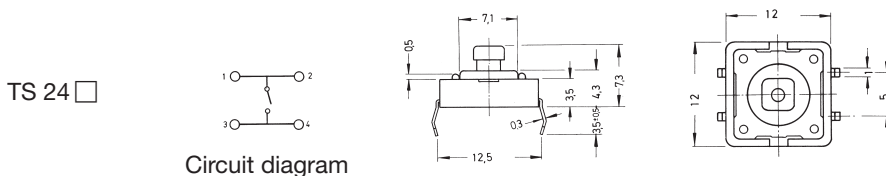
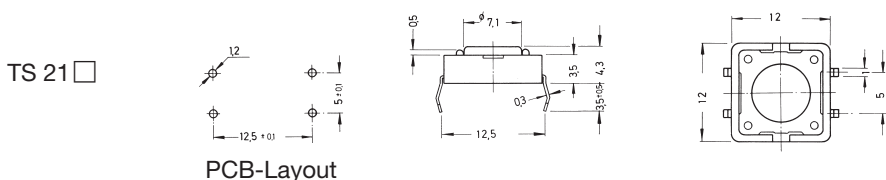

Ordering code:

Switches **TS**

Dimension	Colour of stem for operating force:
<input type="checkbox"/> 4,3 mm	<input type="checkbox"/> 1,6 N, brown
<input type="checkbox"/> 7,3 mm	<input type="checkbox"/> 2,6 N, red

Caps **KTSC-2**

Cap type:	Cap colour:
<input type="checkbox"/> square	<input type="checkbox"/> yellow
<input type="checkbox"/> round	<input type="checkbox"/> blue
	<input type="checkbox"/> red
	<input type="checkbox"/> ivory
	<input type="checkbox"/> black
	<input type="checkbox"/> green

Minimum quantity 5000 pcs

Tact Switches for SMT

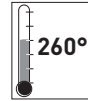

Specifications:

Contact rating:	12 V DC, 50 mA
Contact resistance:	< 100 mΩ
Insulation resistance:	> 100 MΩ at 500 V DC
Dielectric strength:	250 V, 50 Hz for the duration of 1 minute
Operating temperature:	- 40° to + 85° C
Electrical life:	1,0 N/1,6 N: minimum 200 000 cycles 2,6 N: minimum 100 000 cycles 3,2 N/5,2 N: minimum 100 000 cycles
Operating force:	see ordering code
Contacts:	phosphor bronze, silver-plated
Terminals:	brass, silver-plated
Material:	cover: stainless steel base and stem: nylon meets UL 94 V-0; caps ABS
Mounting:	on pc-board – SMD
Soldering conditions:	hand-soldering – max.: 30 W, 2 sec, 320° C
Travel:	0,25 mm + 0,2/- 0,1 mm

Models:

TSS 6

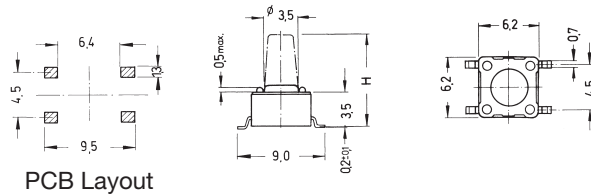

TSS 644

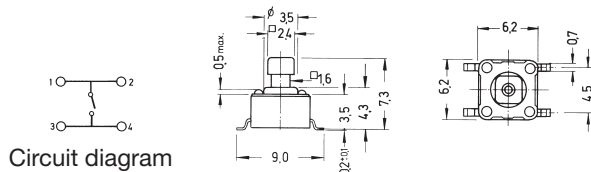

Caps for TSS 644



Ordering code:

Switches

TSS 6

Dimension H / Packaging

- ① 4,3 mm / 1000 pcs / reel
- ② 5,0 mm / 900 pcs / reel
- ③ 7,0 mm / 700 pcs / reel
- ④ 7,3 mm / 500 pcs / reel*
- ⑤ 9,5 mm / 380 pcs / reel
- ⑥ 13,0 mm / 77 pcs / tube

Colour of stem for operating force:

- Ⓚ 1,0 N, black
- Ⓝ 1,6 N, brown
- Ⓡ 2,6 N, red
- Ⓢ 3,2 N, salmon
- Ⓨ 5,2 N, yellow

* only with square stem

Caps KTSC-6

Cap type:

- ① square
- ② round

Cap colour:

- Ⓨ yellow
- Ⓟ blue
- Ⓡ red
- Ⓛ ivory
- Ⓚ black
- Ⓞ green



Tact Switches

Specifications:

Contact rating:	12 V DC, 50 mA
Contact resistance:	< 100 mΩ
Insulation resistance:	> 100 MΩ at 500 V DC
Dielectric strength:	250 V, 50 Hz for the duration of 1 minute
Operating temperature:	- 40° to + 85° C
Electrical life:	1,0 N/1,6 N: minimum 200 000 cycles 2,6 N: minimum 100 000 cycles 3,2 N/5,2 N: minimum 100 000 cycles
Operating force:	see ordering code
Contacts:	phosphor bronze, silver-plated
Terminals:	PC terminals, brass, silver-plated
Material:	cover: stainless steel base and stem: nylon meets UL 94 V-0; caps ABS
Mounting:	on pc-board
Soldering conditions:	hand-soldering – max.: 30 W, 2 sec, 320° C auto-soldering – max.: 5 sec, 260° C subject to PCB 1,6 mm thickness

Travel: 0,25 mm + 0,2/- 0,1 mm

Models:

TS 6

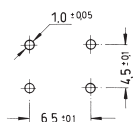

PCB Layout

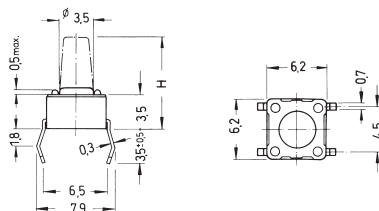

TS 644



Circuit diagram

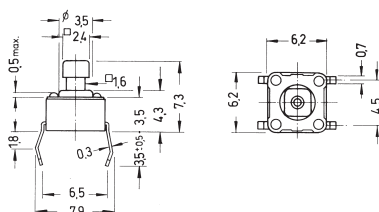

Caps for TS 644

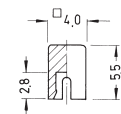

KTSC-61

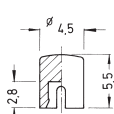

KTSC-62

Ordering code:

Switches TS 6

Dimension H

- 1 4,3 mm
- 2 5,0 mm
- 3 7,0 mm
- 44 7,3 mm*
- 5 9,5 mm
- 6 13,0 mm

Colour of stem for operating force:

- K 1,0 N, black
- N 1,6 N, brown
- R 2,6 N, red
- S 3,2 N, salmon
- Y 5,2 N, yellow

* only with square stem

Caps KTSC-6

Cap type:

- 1 square
- 2 round

Cap colour:

- Y yellow
- B blue
- R red
- I ivory
- K black
- G green

Tact Switches

Specifications:

Contact rating:	12 V DC, 50 mA
Contact resistance:	< 100 mΩ
Insulation resistance:	> 100 MΩ at 500 V DC
Dielectric strength:	250 V, 50 Hz for the duration of 1 minute
Operating temperature:	- 40° to + 85° C
Electrical life:	1,0 N/1,6 N: minimum 1000 000 cycles 2,6 N: minimum 500 000 cycles 3,2 N/5,2 N: minimum 300 000 cycles
Operating force:	see ordering code
Contacts:	phosphor bronze, silver-plated
Terminals:	PC terminals, brass, silver-plated
Material:	cover: steel, tin-plated base and stem: nylon meets UL 94 V-0; caps ABS
Mounting:	on pc-board
Soldering conditions:	hand-soldering – max.: 30 W, 2 sec, 320° C auto-soldering – max.: 5 sec, 260° C subject to PCB 1,6 mm thickness

Travel: 0,25 mm + 0,2/- 0,1 mm

Models:

TS 6□ – RA

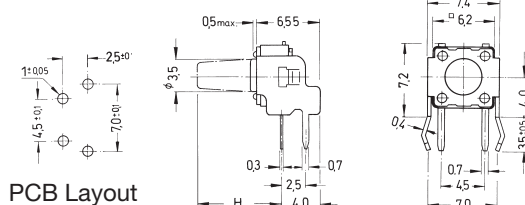

PCB Layout

TS 644□ – RA

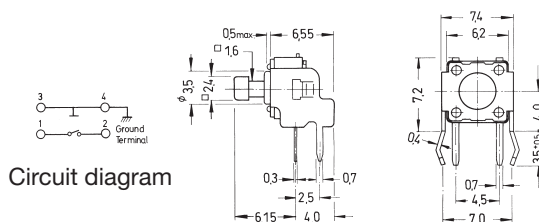

Circuit diagram

Caps for TS 644 □ – RA



KTSC-61□

KTSC-62□

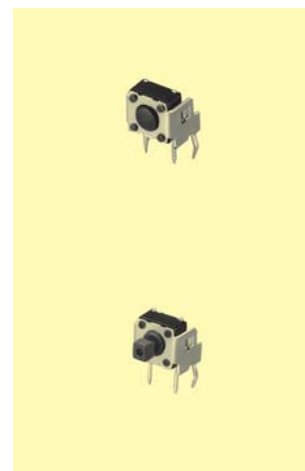

Ordering code:

Switches TS 6□ □ – RA

Dimension H

- 1 3,15 mm
- 2 3,85 mm
- 3 5,85 mm
- 4 6,15 mm*
- 5 8,35 mm
- 6 11,85 mm

Colour of stem for operating force:

- K 1,0 N, black
- N 1,6 N, brown
- R 2,6 N, red
- S 3,2 N, salmon
- Y 5,2 N, yellow

* only with square stem

Caps KTSC-6□ □

Cap type:

- 1 square
- 2 round

Cap colour:

- Y yellow
- B blue
- R red
- I ivory
- K black
- G green

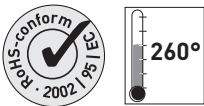

Microminiature Tact Switches for SMT

Specifications:

Contact rating:	24 V DC, 100 mA max.
Contact resistance:	< 100 mΩ
Insulation resistance:	> 100 MΩ at 500 V DC
Dielectric strength:	250 V AC, 50 Hz for the duration of 1 minute
Operating temperature:	- 55° to + 125° C
Electrical life:	minimum 100 000 cycles
Operating force:	3,0 ± 1,0 N
Contacts/terminals:	gold-plated
Material:	cover: stainless steel, base and stem: high-temp. nylon meets UL 94 V-0, washable
Mounting:	on pc-board – SMD
Soldering conditions:	max.: 5 sec, 260° C
Travel:	max. 1,27 mm

3

Models:

Switching functions:

washable

TMSE 10

off – mom

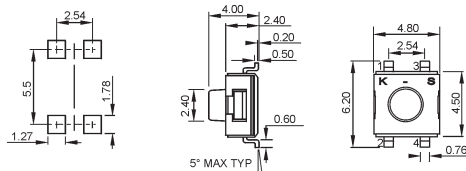

TMSE 10 J

off – mom

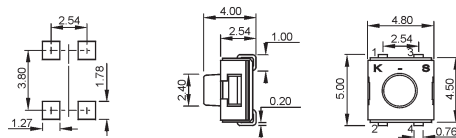

TMSE 10 J-RA

off – mom

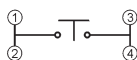
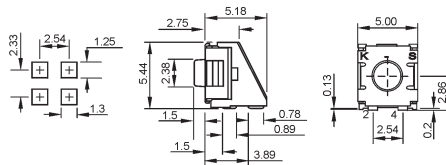

Packaging:

TMSE 10:	500 pcs/reel
TMSE 10 J:	500 pcs/reel
TMSE 10 J-RA:	200 pcs/reel

Tact Switches for SMT

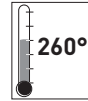

Specifications:

Contact rating:	12 V DC, 50 mA
Contact resistance:	< 100 mΩ
Insulation resistance:	> 100 MΩ at 500 V DC
Dielectric strength:	250 V, 50 Hz for the duration of 1 minute
Operating temperature:	- 25° to + 85° C
Electrical life:	TSSE 66/68 minimum 100 000 cycles TSSE 65/67/69 minimum 500 000 cycles
Operating force:	see ordering code
Contacts:	phosphor bronze, silver-plated
Terminals:	brass, silver-plated
Material:	cover: stainless steel base: high-temp. nylon meets UL 94 V-0, washable stem: TSSE 66: nylon – TSSE 65/67/68/69: silicone rubber
Mounting:	on pc-board – SMD
Packaging:	on tapes – see ordering code

3

washable

Models:

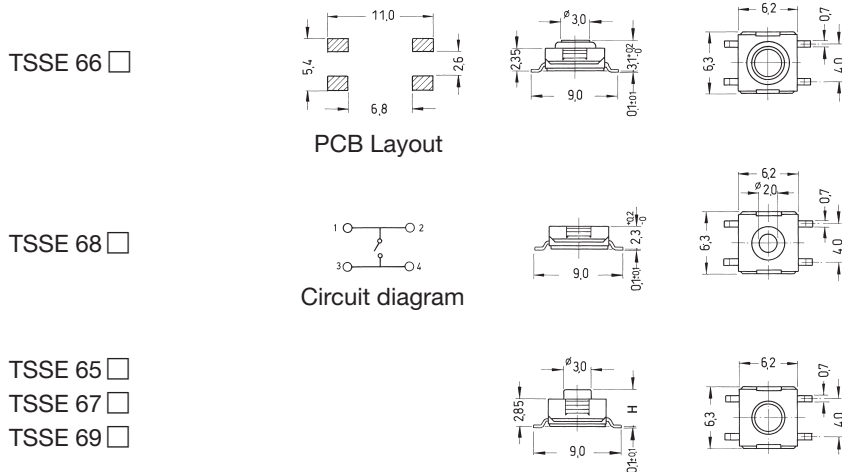

Ordering code:

TSSE

Dimension H

<input type="checkbox"/> 5	3,5 mm, travel: 0,45 ± 0,2	brown	(N) / 1900 pieces/reel
<input type="checkbox"/> 5	3,5 mm, travel: 0,45 ± 0,2	red	(R) / 1900 pieces/reel
<input type="checkbox"/> 5	3,5 mm, travel: 0,45 ± 0,2	transparent	(T) / 1900 pieces/reel
<input type="checkbox"/> 6	3,1 mm, travel: 0,25 + 0,2/- 0,1	brown	(N) / 2000 pieces/reel
<input type="checkbox"/> 7	5,2 mm, travel: 0,45 ± 0,2	brown	(N) / 900 pieces/reel
<input type="checkbox"/> 7	5,2 mm, travel: 0,45 ± 0,2	red	(R) / 900 pieces/reel
<input type="checkbox"/> 7	5,2 mm, travel: 0,6 ± 0,2	transparent	(T) / 900 pieces/reel
<input type="checkbox"/> 8	2,3 mm, travel: 0,25 + 0,2/- 0,1	silver	(S) / 2000 pieces/reel
<input type="checkbox"/> 9	3,8 mm, travel: 0,45 ± 0,2	red	(R) / 1900 pieces/reel
<input type="checkbox"/> 9	3,8 mm, travel: 0,45 ± 0,2	brown	(N) / 1900 pieces/reel
<input type="checkbox"/> 9	3,8 mm, travel: 0,6 ± 0,2	transparent	(T) / 1900 pieces/reel

Colour of stem

for operating force:

<input type="checkbox"/> S	1,6 N, silver
<input type="checkbox"/> N	1,6 N, brown
<input type="checkbox"/> R	2,6 N, red
<input type="checkbox"/> T	3,6 N, transparent

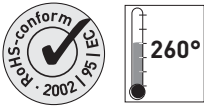

Tact Switches for SMT

Specifications:

Contact rating:	12 V DC, 50 mA
Contact resistance:	< 100 mΩ
Insulation resistance:	> 100 MΩ at 500 V DC
Dielectric strength:	250 V, 50 Hz for the duration of 1 minute
Operating temperature:	- 25° to + 85° C
Electrical life:	TSSE 66-J/68-J: minimum 100 000 cycles TSSE 65-J/67-J/69-J: minimum 500 000 cycles
Operating force:	see ordering code
Contacts:	phosphor bronze, silver-plated
Terminals:	brass, silver-plated
Material:	cover: stainless steel base: high-temp. nylon meets UL 94 V-0, washable stem: TSSE 66 J: nylon – TSSE 65/67/68/69 J: silicone rubber
Mounting:	on pc-board – SMD
Packaging:	on tapes – see ordering code

3

Models:

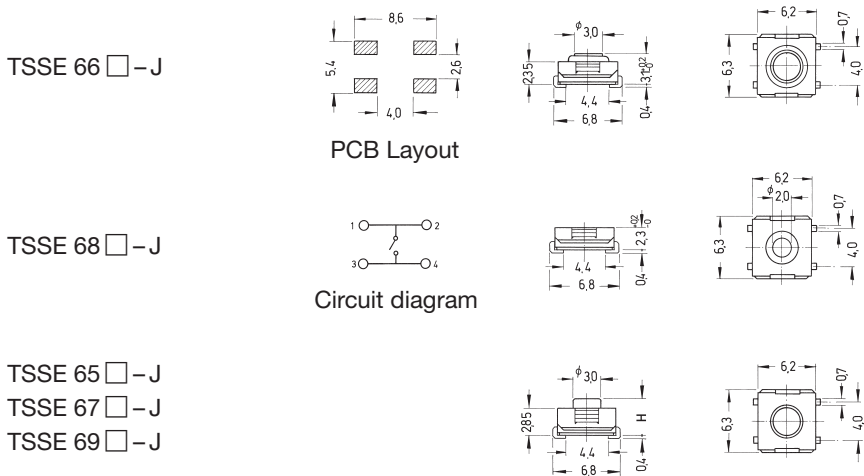

washable



Ordering code:

TSSE □ □ -J

Dimension H

65	3,5 mm, travel: 0,45 ± 0,2	brown	(N) / 1800 pieces/reel
65	3,5 mm, travel: 0,45 ± 0,2	red	(R) / 1800 pieces/reel
65	3,5 mm, travel: 0,45 ± 0,2	transparent	(T) / 1800 pieces/reel
66	3,1 mm, travel: 0,25 + 0,2/- 0,1	brown	(N) / 1900 pieces/reel
67	5,2 mm, travel: 0,45 ± 0,2	brown	(N) / 900 pieces/reel
67	5,2 mm, travel: 0,45 ± 0,2	red	(R) / 900 pieces/reel
67	5,2 mm, travel: 0,6 ± 0,2	transparent	(T) / 900 pieces/reel
68	2,3 mm, travel: 0,25 + 0,2/- 0,1	silver	(S) / 2000 pieces/reel
69	3,8 mm, travel: 0,45 ± 0,2	red	(R) / 1800 pieces/reel
69	3,8 mm, travel: 0,45 ± 0,2	brown	(N) / 1800 pieces/reel
69	3,8 mm, travel: 0,6 ± 0,2	transparent	(T) / 1800 pieces/reel

Colour of stem

for operating force:

S	1,6 N, silver
N	1,6 N, brown
R	2,6 N, red
T	3,6 N, transparent

Tact Switches



Specifications:

Contact rating:	12 V DC, 50 mA
Contact resistance:	< 100 mΩ
Insulation resistance:	> 100 MΩ at 500 V DC
Dielectric strength:	250 V, 50 Hz for the duration of 1 minute
Operating temperature:	- 25° to + 70° C
Electrical life:	TSE 66/68 minimum 100 000 cycles TSE 69 minimum 500 000 cycles
Operating force:	see ordering code
Contacts:	phosphor bronze, silver-plated
Terminals:	PC terminals brass, silver-plated
Material:	cover: stainless steel base: high-temp. nylon meets UL 94 V-0, washable stem: TSE 66: nylon – TSE 68/69: silicone rubber
Mounting:	on pc-board
Soldering conditions:	hand-soldering – max.: 30 W, 2 sec, 320° C auto-soldering – max.: 5 sec, 260° C subject to PCB 1,6 mm thickness

Models:

TSE 66 □

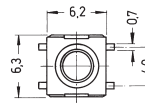
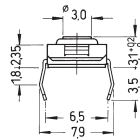
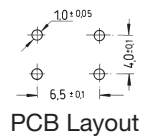

TSE 68 □

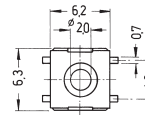
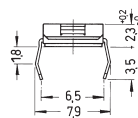
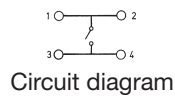

TSE 69 □

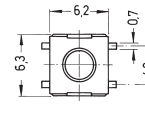
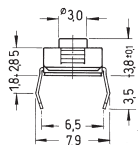

washable



Ordering code:

TSE □ □ □

Dimension

66	3,1 mm, travel: 0,25 + 0,2/- 0,1	brown (N)
68	2,3 mm, travel: 0,25 + 0,2/- 0,1	silver (S)
69	3,8 mm, travel: 0,45 ± 0,2	red (R)
69	3,8 mm, travel: 0,45 ± 0,2	brown (N)

Colour of stem for operating force:

S	1,6 N, silver
N	1,6 N, brown
R	2,6 N, red

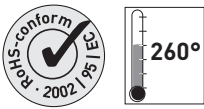

Tact Switches for SMT

Specifications:

Contact rating:	12 V DC, 50 mA
Contact resistance:	100 mΩ max.
Insulation resistance:	100 MΩ min.
Dielectric strength:	250 V AC (50 Hz or 60 Hz) for 1 minute
Operating temperature:	- 25° to + 70° C
Operating force:	see ordering code
Mechanical life:	minimum 500 000 cycles
Cover:	nickel, silver-plated
Case:	high-temp. PA 9T UL 94 V-0, black
Stem:	silicone
Contacts:	phosphor bronze, silver-plated
Terminals:	brass, silver-plated

3

Models:

TSSE 6 -RA

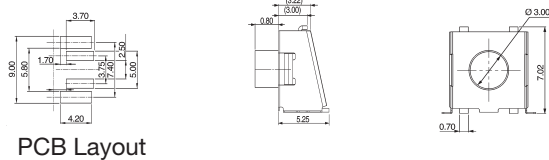

PCB Layout

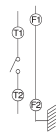

Circuit diagram

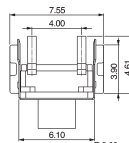

TSSE 6 -RA-1

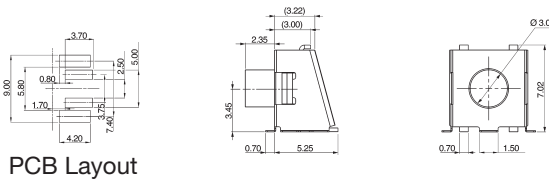

PCB Layout

washable



Ordering code:

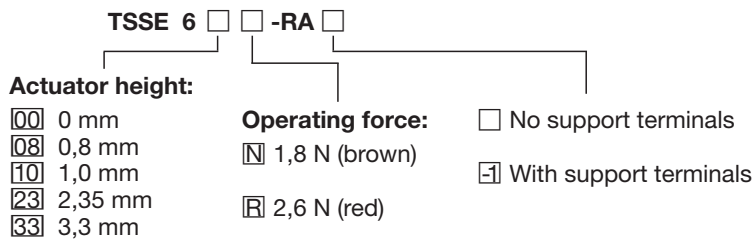

Tact Switches for SMT



Specifications:

Contact rating:	12 V DC, 50 mA / 1 V DC, 0,5 mA
Contact resistance:	< 100 mΩ
Insulation resistance:	> 2 GΩ at 100 V DC
Dielectric strength:	250 V, 50 Hz for the duration of 1 minute
Operating temperature:	- 25° to + 70° C
Electrical life:	minimum 50 000 cycles
Operating Force:	2,15 N ± 0,6 N
Contacts:	metal contact, stainless steel, silver-plated
Terminals:	phosphor bronze, silver-plated
Material:	case: PPS meets UL 94 V-0, brown button: PA meets UL 94 V-0, black frame: phosphor bronze, tin-plated
Mounting:	on pc-board – SMD
Travel:	0,35 mm

Model:

TSS 4-RA

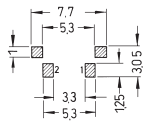

PCB Layout



Circuit diagram

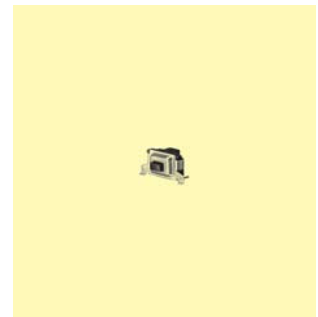
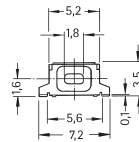
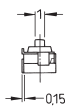
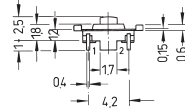

Packaging:

2000 pcs/reel

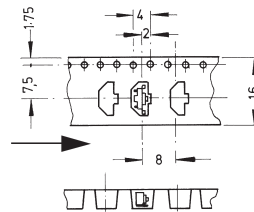

Soldering conditions:

reflow-soldering: 40 sec, 200° C
peak temperature 230° C

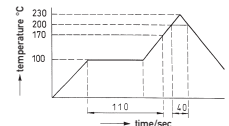

Minimum quantity 1 reel



Tact Switches for SMT

Specifications:

Contact rating:	12 V DC, 50 mA
Contact resistance:	< 100 mΩ
Insulation resistance:	> 100 MΩ at 500 V DC
Dielectric strength:	250 V, 50 Hz for the duration of 1 minute
Operating temperature:	- 25° to + 70° C
Electrical life:	minimum 50 000 cycles
Operating force:	see ordering code
Contacts:	stainless steel, silver-plated
Terminals:	brass, silver-plated
Material:	cover: stainless steel base and stem: high-temp. nylon meets UL 94 V-0 or PPA
Mounting:	TS 3: on PC-board TSS 3: on PC-board – SMD
Soldering conditions:	TS 3: hand-soldering – max.: 30 W, 2 sec, 320° C auto-soldering – max.: 5 sec, 260° C subject to PCB 1,6 mm thickness TSS 3: reflow-soldering, see page 5
Travel:	0,25 mm + 0,2/- 0,1 mm

3

Models:

TS 3 □ □

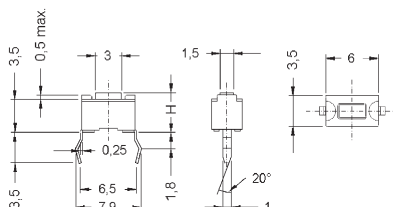
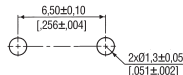

TSS 3 □ □

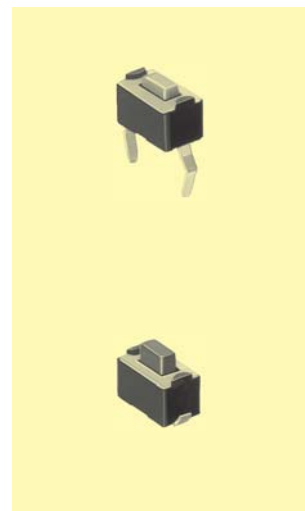
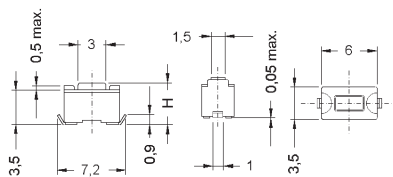
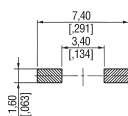

Ordering Code: TS 3 / TSS 3 □ □

Dimension H
 1 4,3 mm
 2 5,0 mm

Colour of stem for operating force:
 N brown, 1,6 N
 S salmon, 3,2 N

Packaging: TS 3 in tubes, 135 pieces / tube
 TSS 31 on tape, 1800 pieces / reel
 TSS 32 on tape, 1600 pieces / reel

Tact Switches for SMT

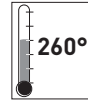

Specification:

Contact rating:	12 V DC, 50 mA
Contact resistance:	< 100 mΩ
Insulation resistance:	> 100 MΩ
Dielectric strength:	250 V, 50–60 Hz for the duration of 1 minute
Operating temperature:	– 40° to + 85° C
Mechanical life:	minimum 100 000 cycles
Contacts:	silver-plated
Operating force:	N: 1,8 N ± 0,5 N S: 3,0 N ± 1,5 N/–0,5 N
Material:	case and actuator = Nylon 46 cover = SUS terminals = C5191R-EH
Mounting:	on pc-board – SMD
Travel:	0,25 mm ± 0,15 mm

Models:

TSS 309 □

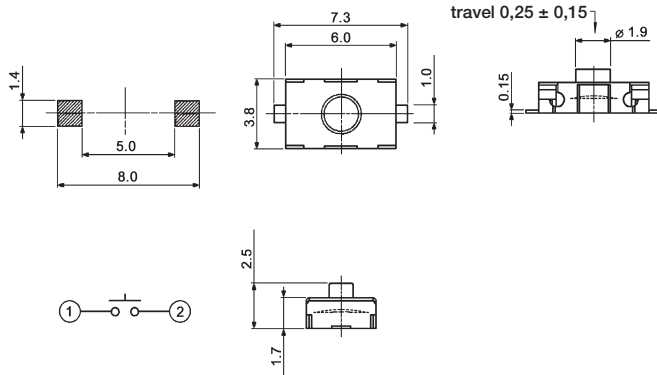

TSS 309 □-J

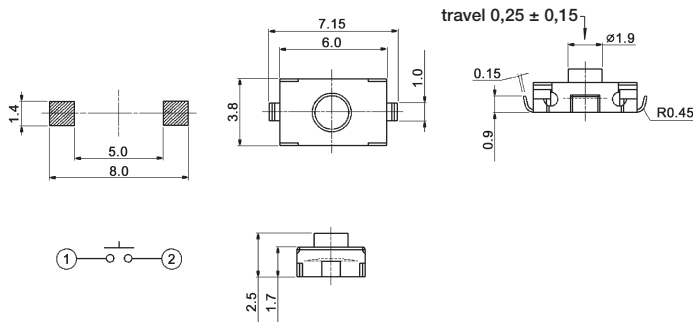

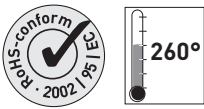

Tact Switches for SMT

Specification:

Contact rating:	12 V DC, 50 mA
Contact resistance:	< 500 mΩ
Insulation resistance:	> 100 MΩ
Dielectric strength:	250 V, 50–60 Hz for the duration of 1 minute
Operating temperature:	– 10° to + 60° C
Operating force:	2,5 N ± 0,7 N
Mechanical life:	minimum 50 000 cycles
Contacts:	silver-plated
Mounting:	on pc-board – SMD

3

Models:

TSS 507

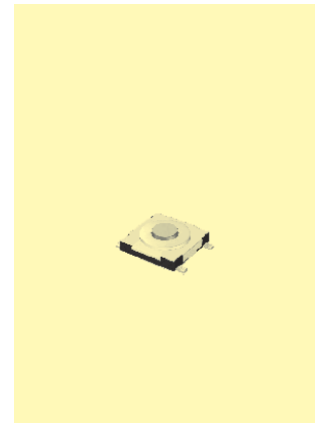
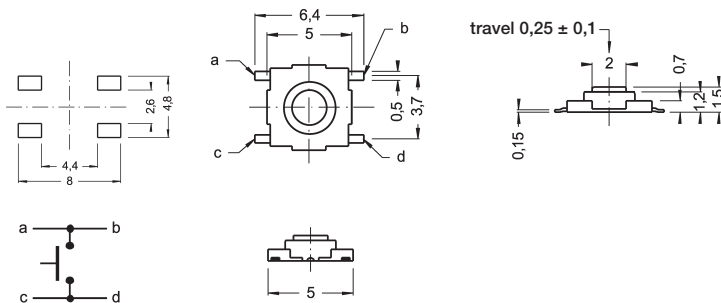

Tact Switches

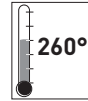

Specification:

Contact rating:	12 V DC, 50 mA
Contact resistance:	< 500 mΩ
Insulation resistance:	> 100 MΩ
Dielectric strength:	250 V, 50–60 Hz for the duration of 1 minute
Operating temperature:	– 20° to + 70° C
Mechanical life:	minimum 50 000 cycles
Contacts:	silver-plated
Mounting:	on pc-board, TSS 313 RA = on pc-board – SMD
Packing unit:	TS 637 RA: 750 pieces/bag TSS 313 RA: 2000 pieces/bag

3

Models:

