

## 8K x 8/9 Dual-Port Static RAM with Sem, Int, Busy

**Features**

- 0.8-micron BiCMOS for high performance
- High-speed access
  - 15 ns (commercial)
  - 25 ns (military)
- Automatic power-down
- Fully asynchronous operation
- Master/Slave select pin allows bus width expansion to 16/18 bits or more
- Busy arbitration scheme provided
- Semaphores included to permit software handshaking between ports
- $\overline{INT}$  flag for port-to-port communication
- Available in 68-pin LCC/PLCC, 64-pin and 80-pin TQFP
- TTL compatible
- Pin compatible and functionally equivalent to IDT7005 and IDT7015

**Functional Description**

The CY7B144 and CY7B145 are high-speed BiCMOS 8K x 8 and 8K x 9 dual-port static RAMs. Various arbitration schemes are included on the CY7B144/5 to handle situations when multiple processors access the same piece of data. Two ports are provided permitting independent, asynchronous access for reads and writes to any location in memory. The CY7B144/5 can be utilized as a standalone 64-Kbit dual-port static RAM or multiple devices can be combined in order to function as a 16/18-bit wider master/slave dual-port static RAM. An M/S pin is provided for implementing 16/18-bit or wider memory applications without the need for separate master and slave devices or additional discrete logic. Application areas include interprocessor/multiprocessor designs, communications status buffering, and dual-port video/graphics memory.

Each port has independent control pins: chip enable ( $\overline{CE}$ ), read or write enable ( $\overline{R/\overline{W}}$ ), and output enable ( $\overline{OE}$ ). Two flags,  $\overline{BUSY}$  and  $\overline{INT}$ , are provided on each port.  $\overline{BUSY}$  signals that the port is trying to access the same location currently being accessed by the other port. The interrupt flag ( $\overline{INT}$ ) permits communication between ports or systems by means of a mail box. The semaphores are used to pass a flag, or token, from one port to the other to indicate that a shared resource is in use. The semaphore logic is comprised of eight shared latches. Only one side can control the latch (semaphore) at any time. Control of a semaphore indicates that a shared resource is in use. An automatic power-down feature is controlled independently on each port by a chip enable ( $\overline{CE}$ ) pin or SEM pin.

The CY7B144 and CY7B145 are available in 68-pin LCCs, PLCCs, 64-pin (CY7B144) and 80-pin TQFP (CY7B145).

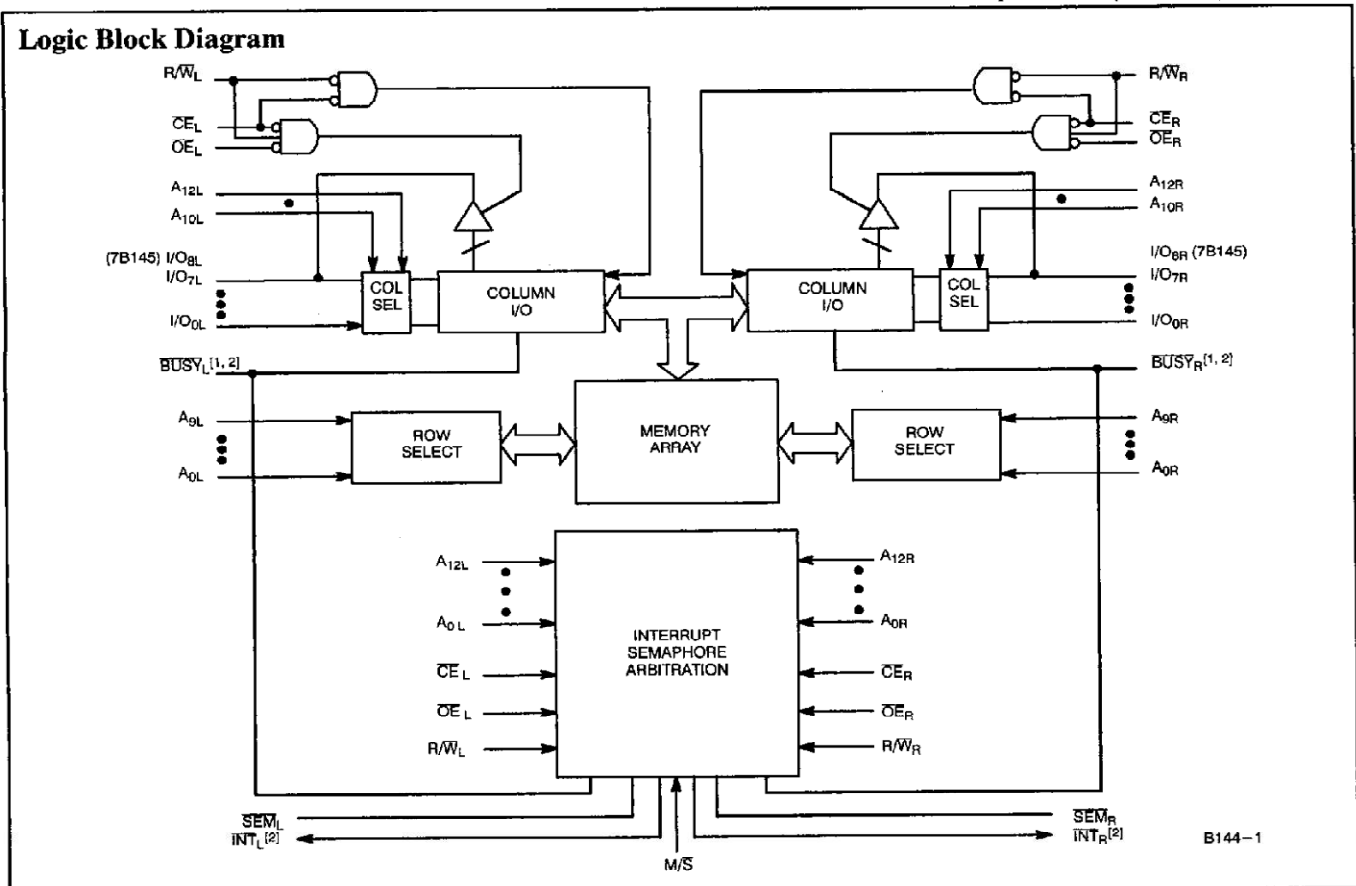
**Notes:**

1.  $\overline{BUSY}$  is an output in master mode and an input in slave mode.
2. Master: push-pull output and requires no pull-up resistor.

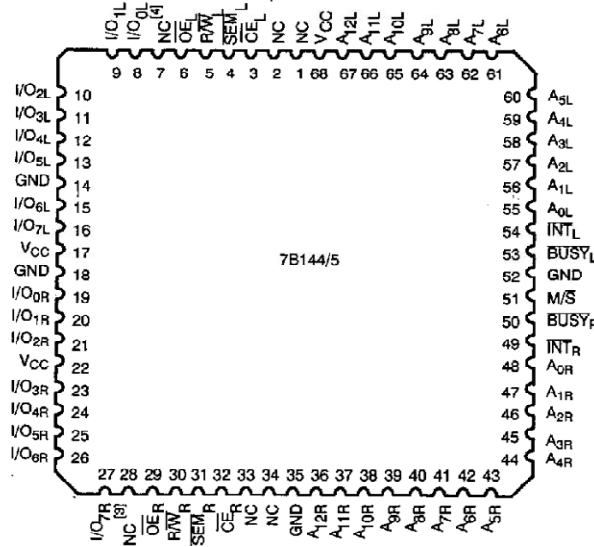
**Pin Configurations**
**68-Pin LCC/PLCC**  
**Top View**

B144-2

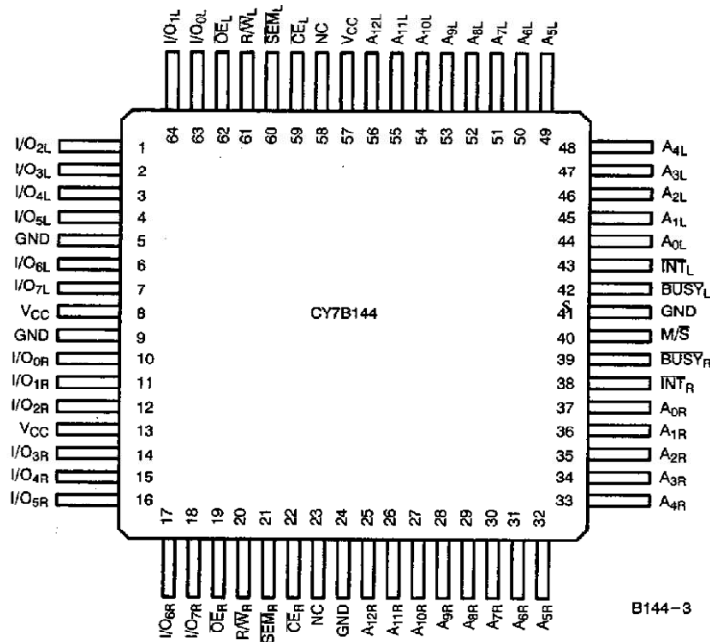
**64-Pin TQFP**  
**Top View**

B144-3

**Notes:**

3. I/O<sub>8R</sub> on the CY7B145.
4. I/O<sub>8L</sub> on the CY7B145.

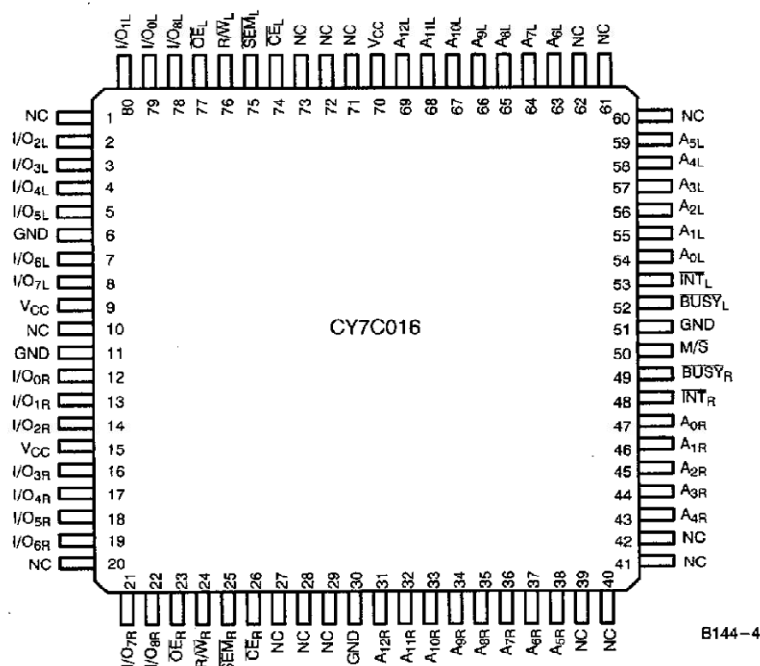
**Pin Configurations (continued)**
**80-Pin TQFP**  
**Top View**

**6**
**Pin Definitions**

Left Port	Right Port	Description
I/O0L-7L(8L)	I/O0R-7R(8R)	Data bus Input/Output
A0L-12L	A0R-12R	Address Lines
CE <sub>L</sub>	CE <sub>R</sub>	Chip Enable
OE <sub>L</sub>	OE <sub>R</sub>	Output Enable
R/W <sub>L</sub>	R/W <sub>R</sub>	Read/Write Enable
SEM <sub>L</sub>	SEM <sub>R</sub>	Semaphore Enable. When asserted LOW, allows access to eight semaphores. The three least significant bits of the address lines will determine which semaphore to write or read. The I/O <sub>0</sub> pin is used when writing to a semaphore. Semaphores are requested by writing a 0 into the respective location.
INT <sub>L</sub>	INT <sub>R</sub>	Interrupt Flag. INT <sub>L</sub> is set when right port writes location 1FFE and is cleared when left port reads location 1FFE. INT <sub>R</sub> is set when left port writes location 1FFF and is cleared when right port reads location 1FFF.
BUSY <sub>L</sub>	BUSY <sub>R</sub>	Busy Flag
M/S		Master or Slave Select
VCC		Power
GND		Ground

**Selection Guide**

		7B144-15 7B145-15	7B144-25 7B145-25	7B144-35 7B145-35	7B144-55 7B145-55
Maximum Access Time (ns)		15	25	35	55
Maximum Operating Current (mA)	Commercial	260	220	210	210
	Military		280	250	
Maximum Standby Current for I <sub>SB1</sub> (mA)	Commercial	110	95	90	90
	Military		100	95	

**Maximum Ratings**

(Above which the useful life may be impaired. For user guidelines, not tested.)

Storage Temperature ..... -65°C to +150°C  
 Ambient Temperature with  
 Power Applied ..... -55°C to +125°C  
 Supply Voltage to Ground Potential ..... -0.5V to +7.0V  
 DC Voltage Applied to Outputs  
 in High Z State ..... -0.5V to +7.0V  
 DC Input Voltage<sup>[5]</sup> ..... -0.5V to +7.0V  
 Output Current into Outputs (LOW) ..... 20 mA

Static Discharge Voltage ..... >2001V  
 (per MIL-STD-883, Method 3015)

Latch-Up Current ..... >200 mA

**Operating Range**

Range	Ambient Temperature	V <sub>CC</sub>
Commercial	0°C to +70°C	5V ± 10%
Industrial	-40°C to +85°C	5V ± 10%
Military <sup>[6]</sup>	-55°C to +125°C	5V ± 10%

**Notes:**

5. Pulse width < 20 ns.

6. T<sub>A</sub> is the "instant on" case temperature.

**Electrical Characteristics Over the Operating Range<sup>[7]</sup>**

Parameter	Description	Test Conditions	7B144-15 7B145-15		7B144-25 7B145-25		Unit	
			Min.	Max.	Min.	Max.		
V <sub>OH</sub>	Output HIGH Voltage	V <sub>CC</sub> = Min., I <sub>OH</sub> = -4.0 mA	2.4		2.4		V	
V <sub>OL</sub>	Output LOW Voltage	V <sub>CC</sub> = Min., I <sub>OL</sub> = 4.0 mA		0.4		0.4	V	
V <sub>IH</sub>	Input HIGH Voltage		2.2		2.2		V	
V <sub>IL</sub>	Input LOW Voltage			0.8		0.8	V	
I <sub>IX</sub>	Input Leakage Current	GND ≤ V <sub>I</sub> ≤ V <sub>CC</sub>	-10	+10	-10	+10	μA	
I <sub>OZ</sub>	Output Leakage Current	Outputs Disabled, GND ≤ V <sub>O</sub> ≤ V <sub>CC</sub>	-10	+10	-10	+10	μA	
I <sub>CC</sub>	Operating Current	V <sub>CC</sub> = Max., I <sub>OUT</sub> = 0 mA Outputs Disabled	Com'l		260		220	mA
			Mil/Ind				280	
I <sub>SB1</sub>	Standby Current (Both Ports TTL Levels)	$\overline{CE}_L$ and $\overline{CE}_R \geq V_{IH}$ , f = f <sub>MAX</sub> <sup>[8]</sup>	Com'l		110		95	mA
			Mil/Ind				100	
I <sub>SB2</sub>	Standby Current (One Port TTL Level)	$\overline{CE}_L$ or $\overline{CE}_R \geq V_{IH}$ , f = f <sub>MAX</sub> <sup>[8]</sup>	Com'l		165		145	mA
			Mil/Ind				180	
I <sub>SB3</sub>	Standby Current (Both Ports CMOS Levels)	Both Ports $\overline{CE}$ and $\overline{CE}_R \geq V_{CC} - 0.2V$ , V <sub>IN</sub> ≥ V <sub>CC</sub> - 0.2V or V <sub>IN</sub> ≤ 0.2V, f = 0 <sup>[8]</sup>	Com'l		15		15	mA
			Mil/Ind				30	
I <sub>SB4</sub>	Standby Current (One Port CMOS Level)	One Port $\overline{CE}_L$ or $\overline{CE}_R \geq V_{CC} - 0.2V$ , V <sub>IN</sub> ≥ V <sub>CC</sub> - 0.2V or V <sub>IN</sub> ≤ 0.2V, Active Port Outputs, f = f <sub>MAX</sub> <sup>[8]</sup>	Com'l		160		140	mA
			Mil/Ind				160	

Parameter	Description	Test Conditions	7B144-35 7B145-35		7B144-55 7B145-55		Unit	
			Min.	Max.	Min.	Max.		
V <sub>OH</sub>	Output HIGH Voltage	V <sub>CC</sub> = Min., I <sub>OH</sub> = -4.0 mA	2.4		2.4		V	
V <sub>OL</sub>	Output LOW Voltage	V <sub>CC</sub> = Min., I <sub>OL</sub> = 4.0 mA		0.4		0.4	V	
V <sub>IH</sub>	Input HIGH Voltage		2.2		2.2		V	
V <sub>IL</sub>	Input LOW Voltage			0.8		0.8	V	
I <sub>IX</sub>	Input Leakage Current	GND ≤ V <sub>I</sub> ≤ V <sub>CC</sub>	-10	+10	-10	+10	μA	
I <sub>OZ</sub>	Output Leakage Current	Outputs Disabled, GND ≤ V <sub>O</sub> ≤ V <sub>CC</sub>	-10	+10	-10	+10	μA	
I <sub>CC</sub>	Operating Current	V <sub>CC</sub> = Max., I <sub>OUT</sub> = 0 mA Outputs Disabled	Com'l		210		210	mA
			Mil/Ind		250		250	
I <sub>SB1</sub>	Standby Current (Both Ports TTL Levels)	$\overline{CE}_L$ and $\overline{CE}_R \geq V_{IH}$ , f = f <sub>MAX</sub> <sup>[8]</sup>	Com'l		90		90	mA
			Mil/Ind		95		95	
I <sub>SB2</sub>	Standby Current (One Port TTL Level)	$\overline{CE}_L$ or $\overline{CE}_R \geq V_{IH}$ , f = f <sub>MAX</sub> <sup>[8]</sup>	Com'l		135		135	mA
			Mil/Ind		160		160	
I <sub>SB3</sub>	Standby Current (Both Ports CMOS Levels)	Both Ports $\overline{CE}$ and $\overline{CE}_R \geq V_{CC} - 0.2V$ , V <sub>IN</sub> ≥ V <sub>CC</sub> - 0.2V or V <sub>IN</sub> ≤ 0.2V, f = 0 <sup>[8]</sup>	Com'l		15		15	mA
			Mil/Ind		30		30	
I <sub>SB4</sub>	Standby Current (One Port CMOS Level)	One Port $\overline{CE}_L$ or $\overline{CE}_R \geq V_{CC} - 0.2V$ , V <sub>IN</sub> ≥ V <sub>CC</sub> - 0.2V or V <sub>IN</sub> ≤ 0.2V, Active Port Outputs, f = f <sub>MAX</sub> <sup>[8]</sup>	Com'l		130		130	mA
			Mil/Ind		140		140	

**Notes:**

7. See the last page of this specification for Group A subgroup testing information.
8. f<sub>MAX</sub> = 1/t<sub>RC</sub> = All inputs cycling at f = 1/t<sub>RC</sub> (except output enable). f = 0 means no address or control lines change. This applies only to inputs at CMOS level standby I<sub>SB3</sub>.

**Capacitance<sup>[9]</sup>**

Parameter	Description	Test Conditions	Max.	Unit
$C_{IN}$	Input Capacitance	$T_A = 25^\circ\text{C}$ , $f = 1\text{ MHz}$ , $V_{CC} = 5.0\text{V}$	10	pF
$C_{OUT}$	Output Capacitance		15	pF

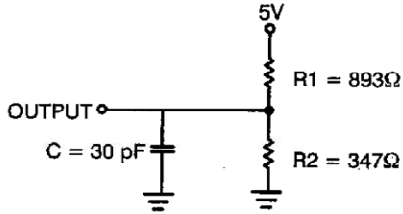
**AC Test Loads and Waveforms**

(a) Normal Load (Load 1)

B144-5

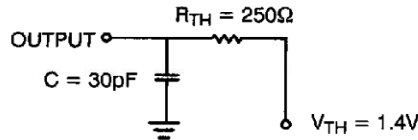

(b) Thévenin Equivalent (Load 1)

B144-6

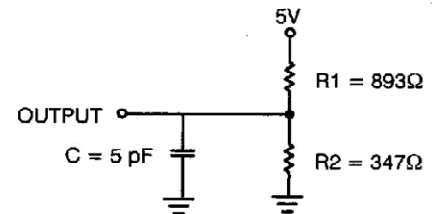

(c) Three-State Delay (Load 3)

B144-7

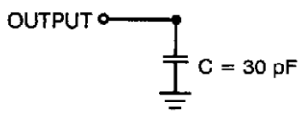

Load (Load 2)

B144-8

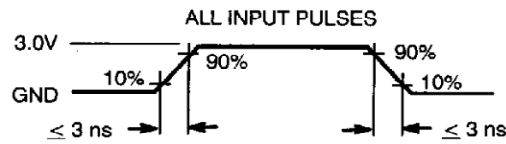

B144-9

**Switching Characteristics Over the Operating Range<sup>[7, 10]</sup>**

Parameter	Description	7B144-15 7B145-15		7B144-25 7B145-25		7B144-35 7B145-35		7B144-55 7B145-55		Unit
		Min.	Max.	Min.	Max.	Min.	Max.	Min.	Max.	
<b>READ CYCLE</b>										
$t_{RC}$	Read Cycle Time	15		25		35		55		ns
$t_{AA}$	Address to Data Valid		15		25		35		55	ns
$t_{OHA}$	Output Hold From Address Change	3		3		3		3		ns
$t_{ACE}$	$\overline{CE}$ LOW to Data Valid		15		25		35		55	ns
$t_{DOE}$	$\overline{OE}$ LOW to Data Valid		10		15		20		25	ns
$t_{LZOE}^{[11, 12]}$	$\overline{OE}$ Low to Low Z	3		3		3		3		ns
$t_{HZOE}^{[11, 12]}$	$\overline{OE}$ HIGH to High Z		10		15		20		25	ns
$t_{LZCE}^{[11, 12]}$	$\overline{CE}$ LOW to Low Z	3		3		3		3		ns
$t_{HZCE}^{[11, 12]}$	$\overline{CE}$ HIGH to High Z		10		15		20		25	ns
$t_{PU}$	$\overline{CE}$ LOW to Power-Up	0		0		0		0		ns
$t_{PD}$	$\overline{CE}$ HIGH to Power-Down		15		25		35		55	ns

**Notes:**

9. Tested initially and after any design or process changes that may affect these parameters.
10. Test conditions assume signal transition time of 3 ns or less, timing reference levels of 1.5V, input pulse levels of 0 to 3.0V, and output loading of the specified  $I_{OL}/I_{OH}$  and 30-pF load capacitance.
11. At any given temperature and voltage condition for any given device,  $t_{HZCE}$  is less than  $t_{LZCE}$  and  $t_{HZOE}$  is less than  $t_{LZOE}$ .
12. Test conditions used are Load 3.

**Switching Characteristics** Over the Operating Range<sup>[7, 10]</sup> (continued)

Parameter	Description	7B144-15 7B145-15		7B144-25 7B145-25		7B144-35 7B145-35		7B144-55 7B145-55		Unit
		Min.	Max.	Min.	Max.	Min.	Max.	Min.	Max.	
<b>WRITE CYCLE</b>										
t <sub>WC</sub>	Write Cycle Time	15		25		35		55		ns
t <sub>SCE</sub>	$\overline{CE}$ LOW to Write End	12		20		30		45		ns
t <sub>AW</sub>	Address Set-Up to Write End	12		20		30		45		ns
t <sub>HA</sub>	Address Hold From Write End	2		2		2		2		ns
t <sub>SA</sub>	Address Set-Up to Write Start	0		0		0		0		ns
t <sub>PWE</sub>	Write Pulse Width	12		20		25		40		ns
t <sub>SD</sub>	Data Set-Up to Write End	10		15		15		25		ns
t <sub>HD</sub>	Data Hold From Write End	0		0		0		0		ns
t <sub>HZWE</sub> <sup>[12]</sup>	R/W LOW to High Z		10		15		20		25	ns
t <sub>LZWE</sub> <sup>[12]</sup>	R/W HIGH to Low Z	3		3		3		3		ns
t <sub>WDD</sub> <sup>[13]</sup>	Write Pulse to Data Delay		30		50		60		70	ns
t <sub>DDD</sub> <sup>[13]</sup>	Write Data Valid to Read Data Valid		25		30		35		40	ns
<b>BUSY TIMING</b> <sup>[14]</sup>										
t <sub>BLA</sub>	BUSY LOW from Address Match		15		20		20		30	ns
t <sub>BHA</sub>	BUSY HIGH from Address Mismatch		15		20		20		30	ns
t <sub>BLC</sub>	BUSY LOW from $\overline{CE}$ LOW		15		20		20		30	ns
t <sub>BHC</sub>	BUSY HIGH from $\overline{CE}$ HIGH		15		20		20		30	ns
t <sub>PS</sub>	Port Set-Up for Priority	5		5		5		5		ns
t <sub>WB</sub>	R/W LOW after BUSY LOW	0		0		0		0		ns
t <sub>WH</sub>	R/W HIGH after BUSY HIGH	13		20		30		30		ns
t <sub>BDD</sub>	BUSY HIGH to Data Valid		15		25		35		55	ns
<b>INTERRUPT TIMING</b> <sup>[14]</sup>										
t <sub>INS</sub>	$\overline{INT}$ Set Time		15		25		25		35	ns
t <sub>INR</sub>	$\overline{INT}$ Reset Time		15		25		25		35	ns
<b>SEMAPHORE TIMING</b>										
t <sub>SOP</sub>	SEM Flag Update Pulse ( $\overline{OE}$ or SEM)	10		10		15		20		ns
t <sub>SWRD</sub>	SEM Flag Write to Read Time	5		5		5		5		ns
t <sub>SPS</sub>	SEM Flag Contention Window	5		5		5		5		ns

**Notes:**

13. For information on part-to-part delay through RAM cells from writing port to reading port, refer to Read Timing with Port-to-Port Delay waveform.

14. Test conditions used are Load 2.

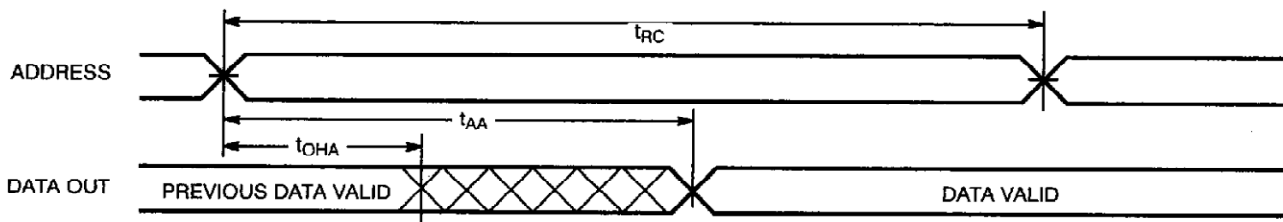
**Switching Waveforms**
**Read Cycle No. 1 (Either Port Address Access)<sup>[15, 16]</sup>**

B144-10

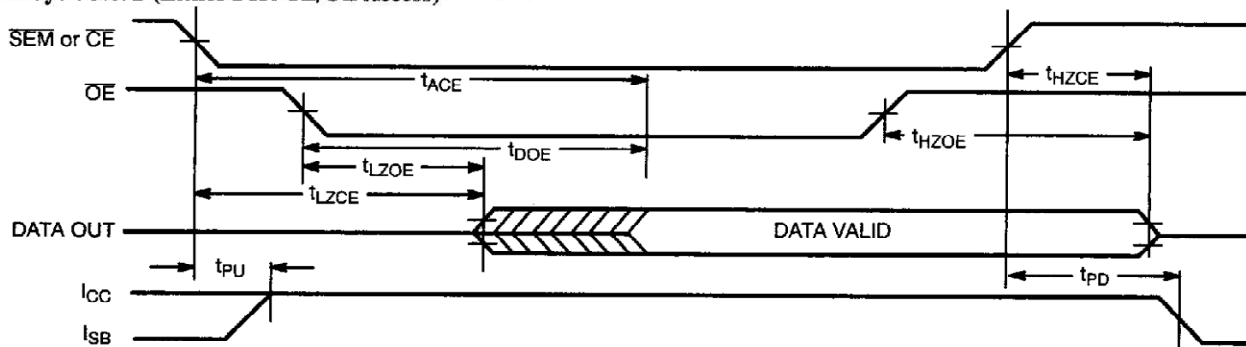
**Read Cycle No. 2 (Either Port  $\overline{CE}/\overline{OE}$  Access)<sup>[15, 17, 18]</sup>**

B144-11

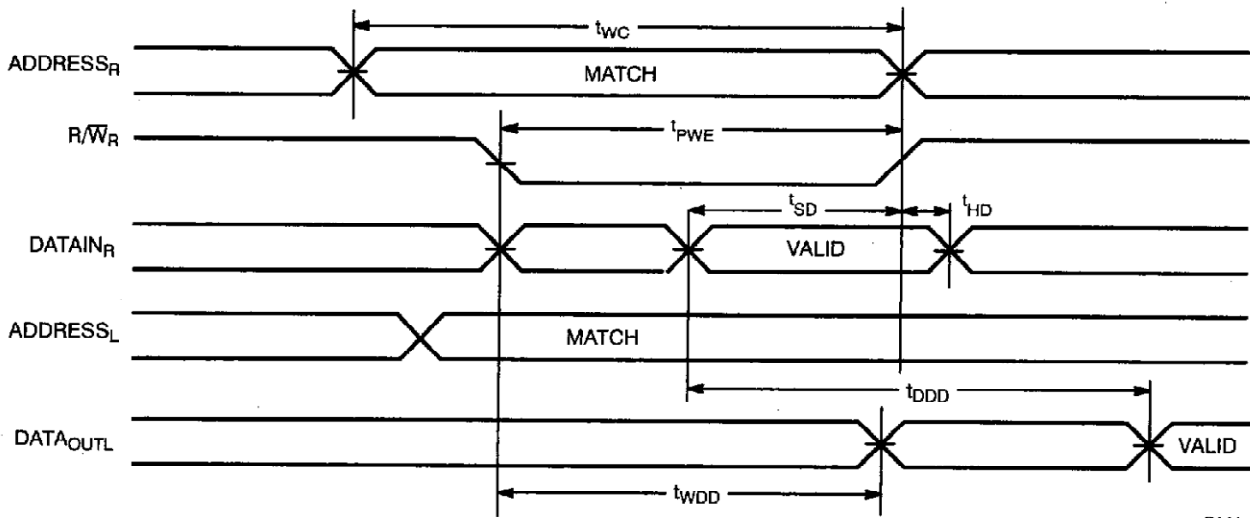
**Read Timing with Port-to-Port Delay ( $M/\overline{S} = L$ )<sup>[19, 20]</sup>**

B144-12

**Notes:**

15.  $R/\overline{W}$  is HIGH for read cycle.
16. Device is continuously selected  $\overline{CE} = \text{LOW}$  and  $\overline{OE} = \text{LOW}$ . This waveform cannot be used for semaphore reads.
17. Address valid prior to or coincident with  $\overline{CE}$  transition LOW.
18.  $\overline{CE}_L = L, \overline{SEM} = H$  when accessing RAM.  $\overline{CE} = H, \overline{SEM} = L$  when accessing semaphores.
19.  $\overline{BUSY} = \text{HIGH}$  for the writing port.
20.  $\overline{CE}_L = \overline{CE}_R = \text{LOW}$ .

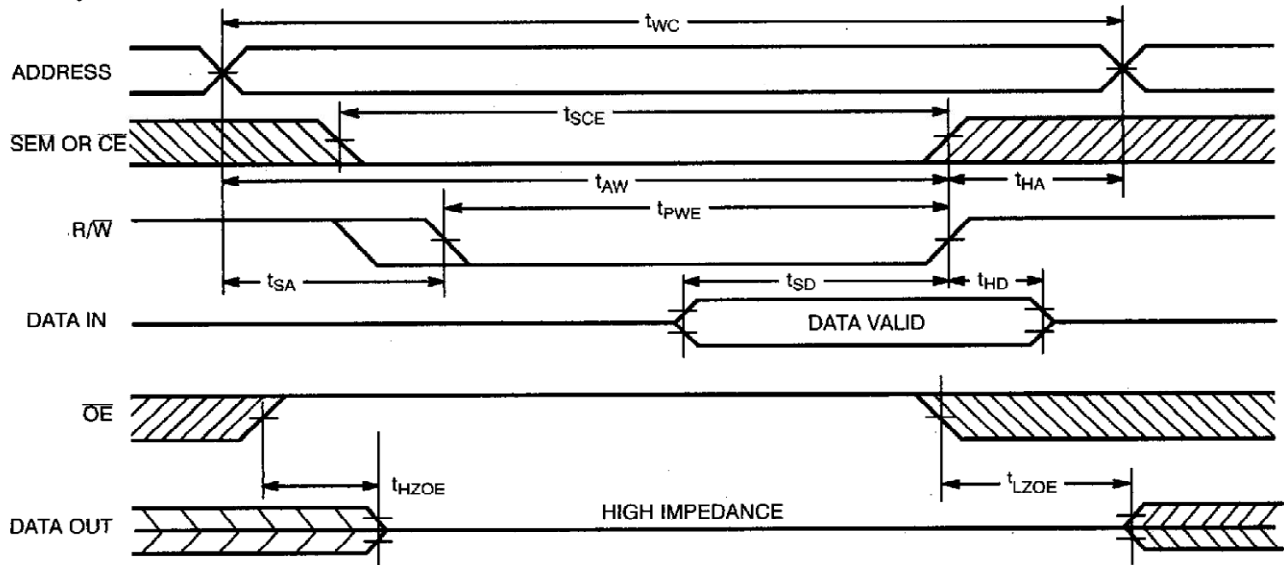

**Switching Waveforms (continued)**
**Write Cycle No. 1:  $\overline{OE}$  Three-State Data I/Os (Either Port)<sup>[21, 22, 23]</sup>**

B144-13

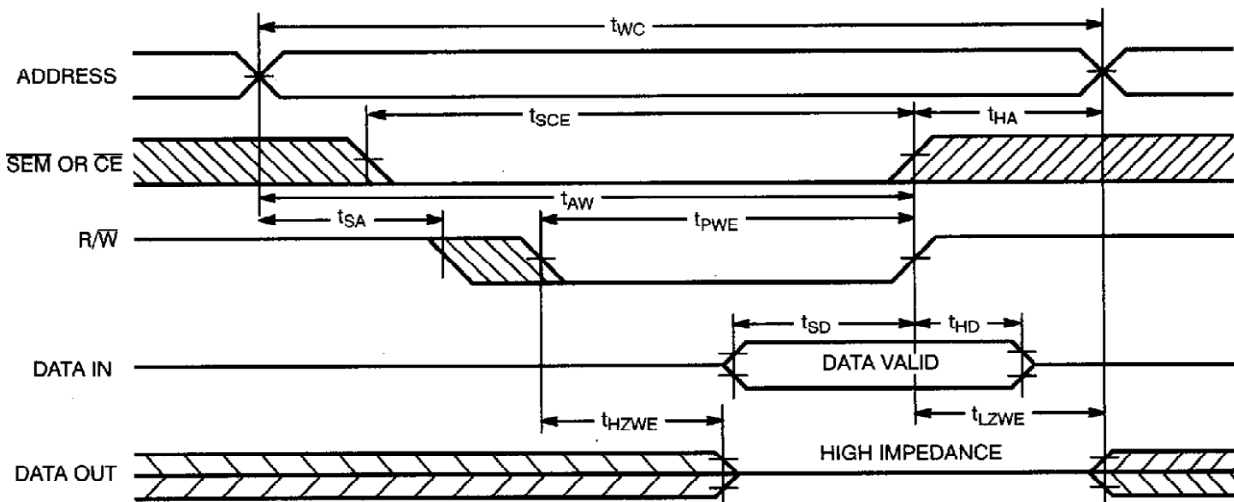
**Write Cycle No. 2:  $R/\overline{W}$  Three-State Data I/Os (Either Port)<sup>[21, 23, 24]</sup>**

B144-14

**Notes:**

21. The internal write time of the memory is defined by the overlap of  $\overline{CE}$  or  $\overline{SEM}$  LOW and  $R/\overline{W}$  LOW. Both signals must be LOW to initiate a write, and either signal can terminate a write by going HIGH. The data input set-up and hold timing should be referenced to the rising edge of the signal that terminates the write.
22. If  $\overline{OE}$  is LOW during a  $R/\overline{W}$  controlled write cycle, the write pulse width must be the larger of  $t_{PWE}$  or  $(t_{HZWE} + t_{SD})$  to allow the I/O

drivers to turn off and data to be placed on the bus for the required  $t_{SD}$ . If  $\overline{OE}$  is HIGH during a  $R/\overline{W}$  controlled write cycle (as in this example), this requirement does not apply and the write pulse can be as short as the specified  $t_{PWE}$ .

23.  $R/\overline{W}$  must be HIGH during all address transitions.
24. Data I/O pins enter high impedance when  $\overline{OE}$  is held LOW during write.

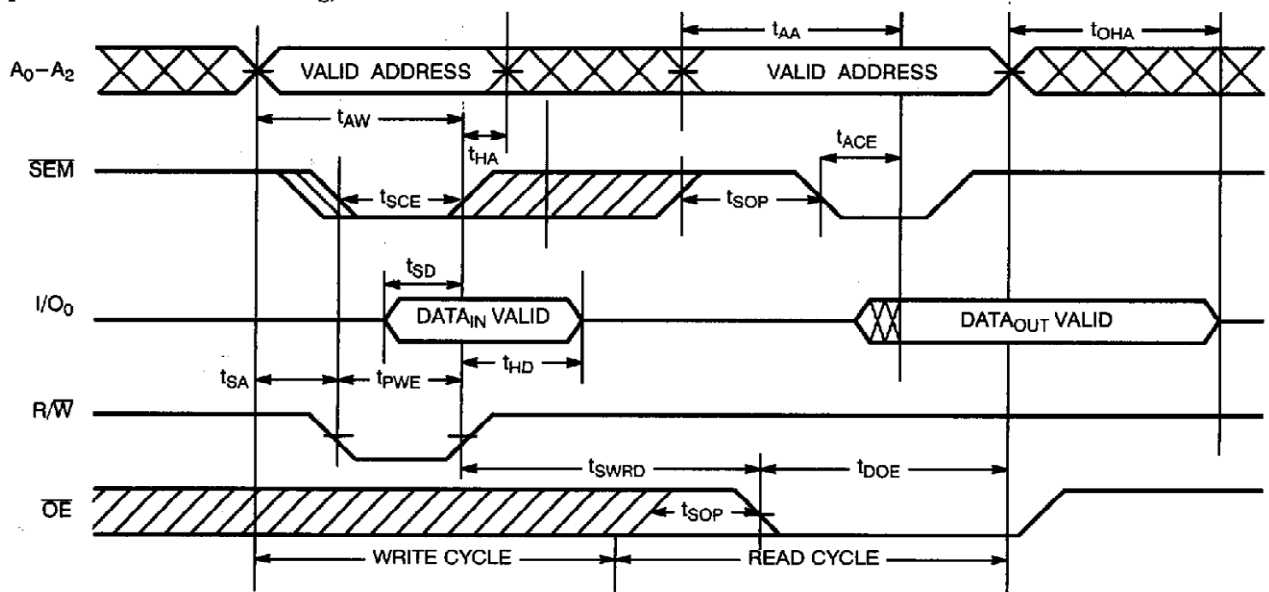
**Switching Waveforms (continued)**
**Semaphore Read After Write Timing, Either Side<sup>[25]</sup>**

B144-15

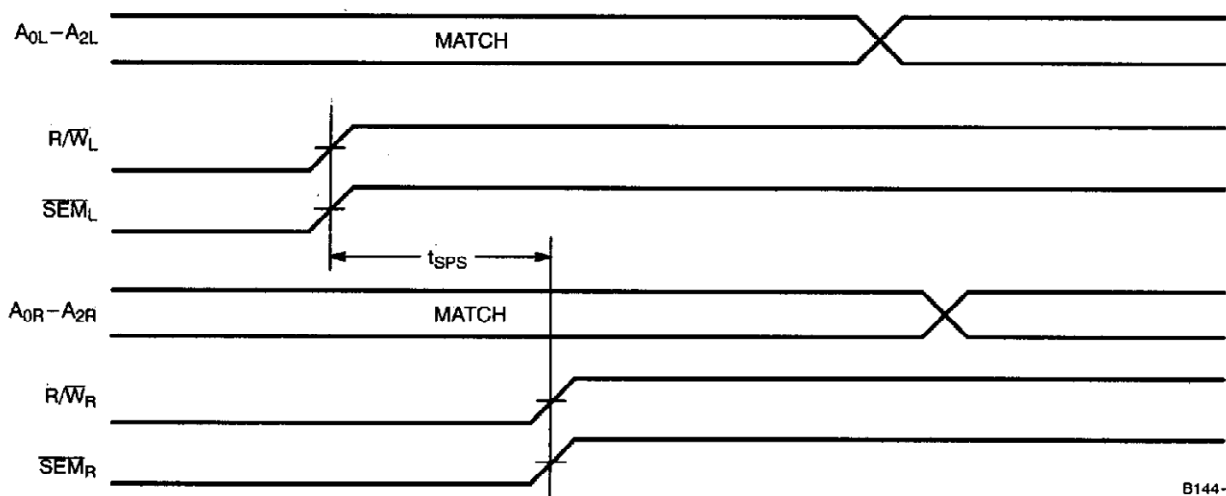
**Semaphore Contention<sup>[26, 27, 28]</sup>**

B144-16

**Notes:**

25.  $\overline{CE} = \text{HIGH}$  for the duration of the above timing (both write and read cycle).  
 26.  $I/O_{0R} = I/O_{0L} = \text{LOW}$  (request semaphore);  $\overline{CE}_R = \overline{CE}_L = \text{HIGH}$   
 27. Semaphores are reset (available to both ports) at cycle start.

28. If  $t_{SPS}$  is violated, the semaphore will definitely be obtained by one side or the other, but there is no guarantee which side will control the semaphore.

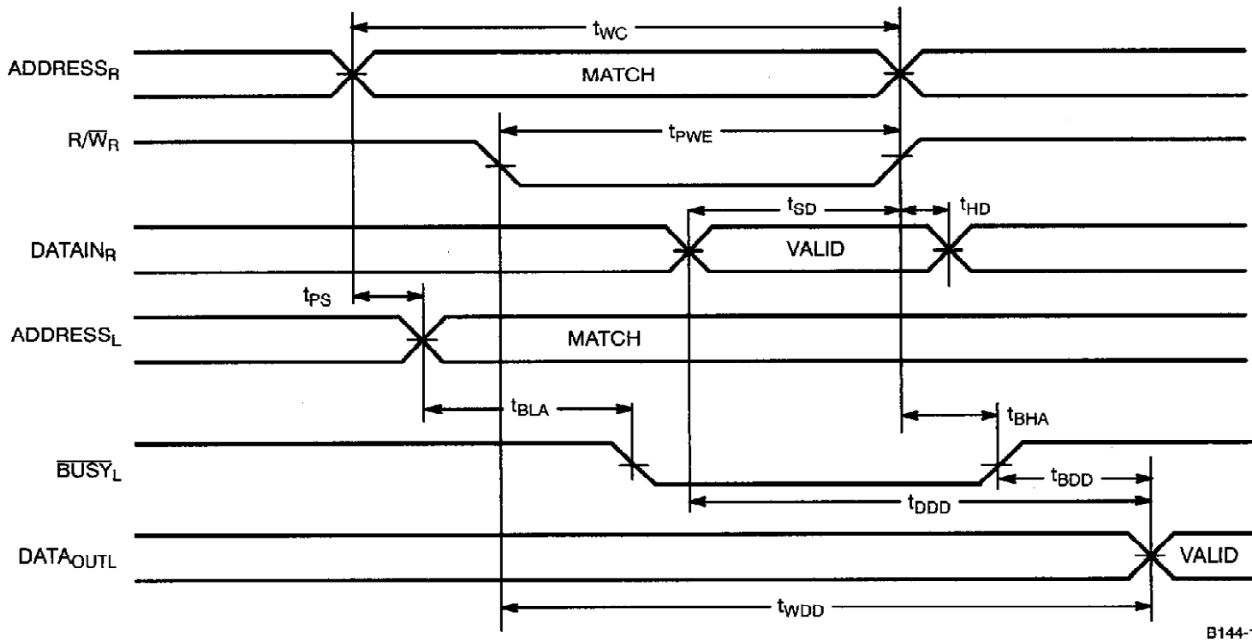
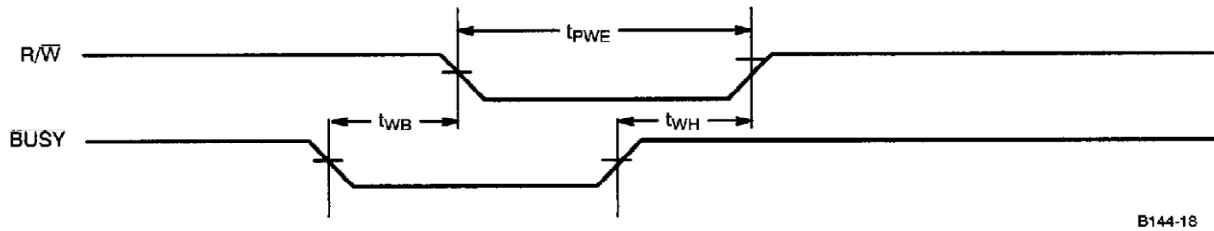
**Switching Waveforms (continued)**
**Read with  $\overline{\text{BUSY}}$  ( $\text{M}/\overline{\text{S}}=\text{HIGH}$ )<sup>[20]</sup>**

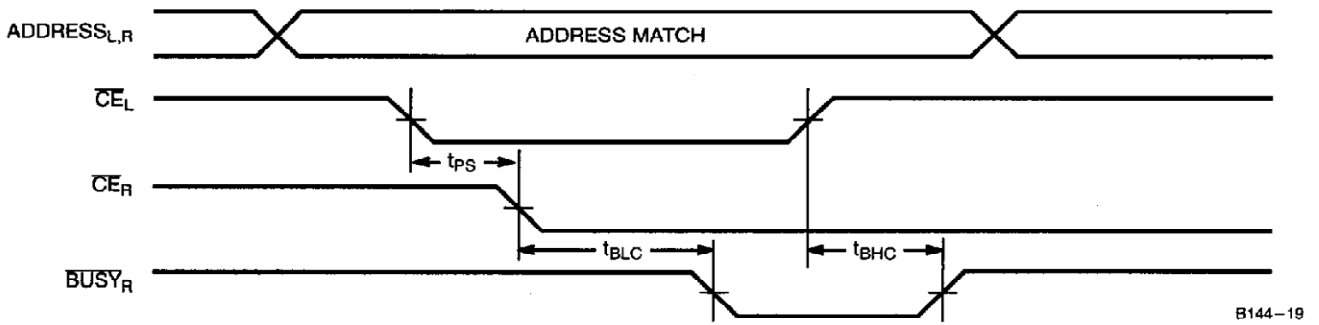
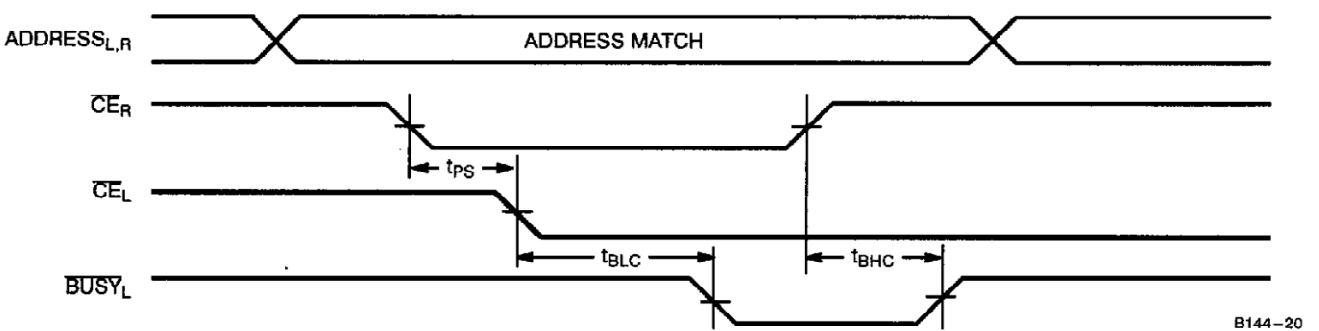
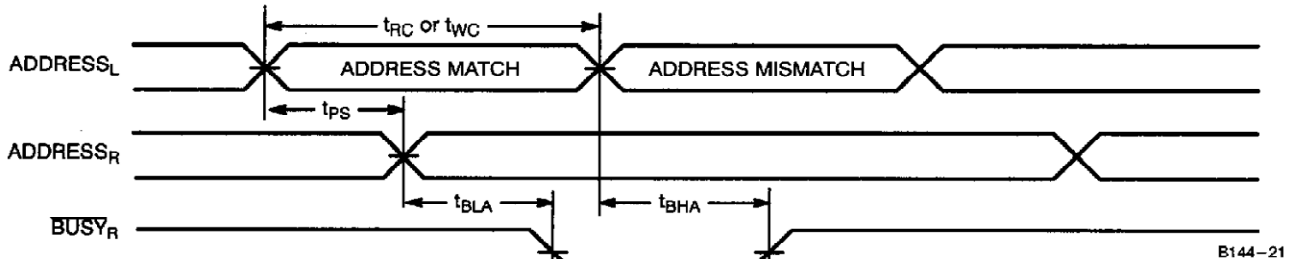
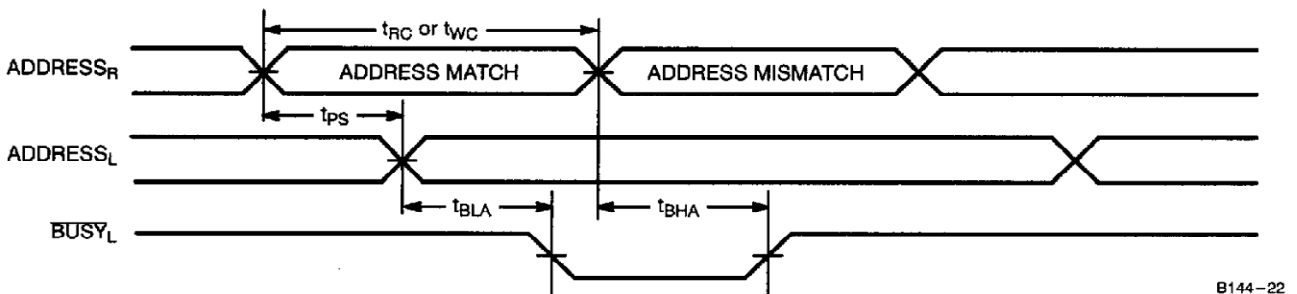
**Write Timing with Busy Input ( $\text{M}/\overline{\text{S}}=\text{LOW}$ )**

**Switching Waveforms (continued)**
**Busy Timing Diagram No. 1 ( $\overline{CE}$  Arbitration)<sup>[29]</sup>**
 **$\overline{CE}_L$  Valid First:**

 **$\overline{CE}_R$  Valid First:**

**Busy Timing Diagram No. 2 (Address Arbitration)<sup>[29]</sup>**
**Left Address Valid First:**

**Right Address Valid First:**

**Note:**

29. If  $t_{PS}$  is violated, the busy signal will be asserted on one side or the other, but there is no guarantee on which side **BUSY** will be asserted.  
 30.  $t_{HA}$  depends on which enable pin ( $\overline{CE}_L$  or  $R/\overline{W}_L$ ) is deasserted first.

31.  $t_{INS}$  or  $t_{INR}$  depends on which enable pin ( $\overline{CE}_L$  or  $R/\overline{W}_L$ ) is asserted last.

Switching Waveforms (continued)

Interrupt Timing Diagrams

Left Side Sets  $\overline{INT}_R$ :

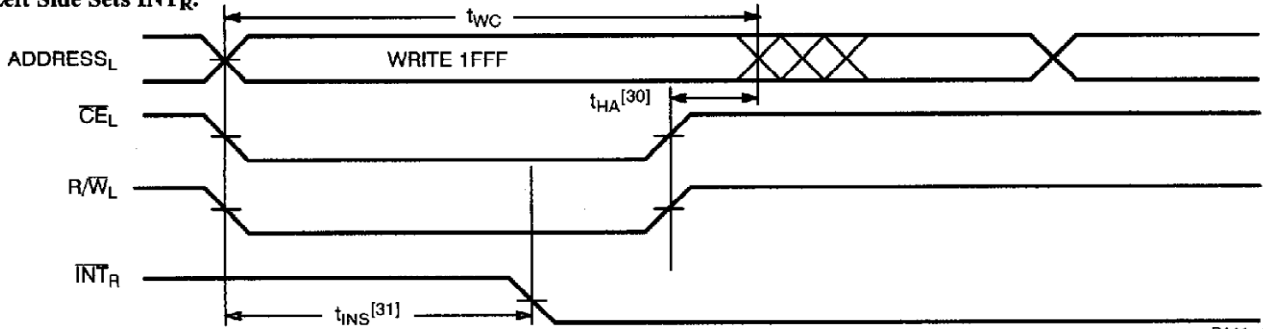

B144-23

Right Side Clears  $\overline{INT}_R$ :

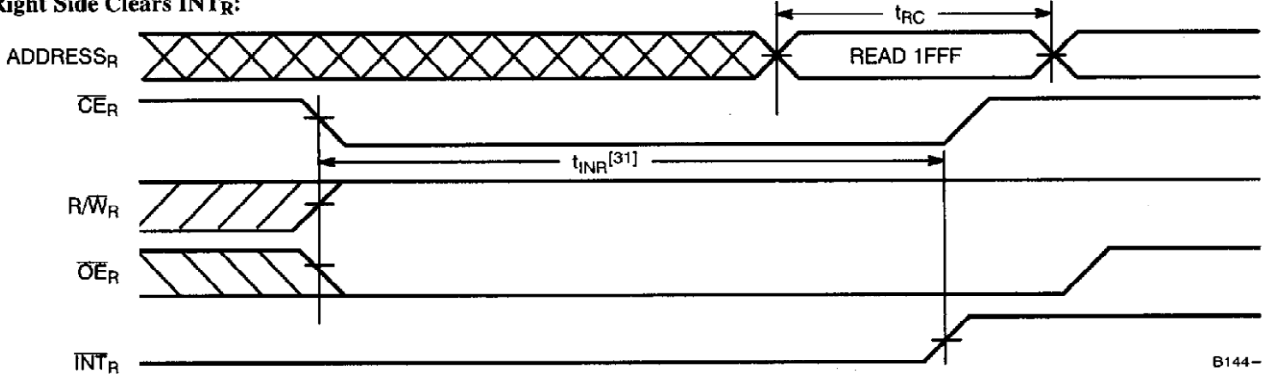

B144-24

Right Side Sets  $\overline{INT}_L$ :

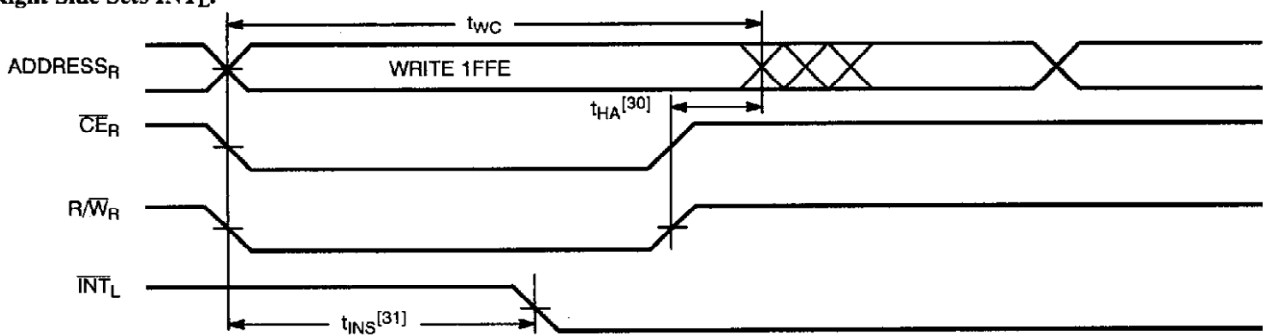

B144-25

Left Side Clears  $\overline{INT}_L$ :

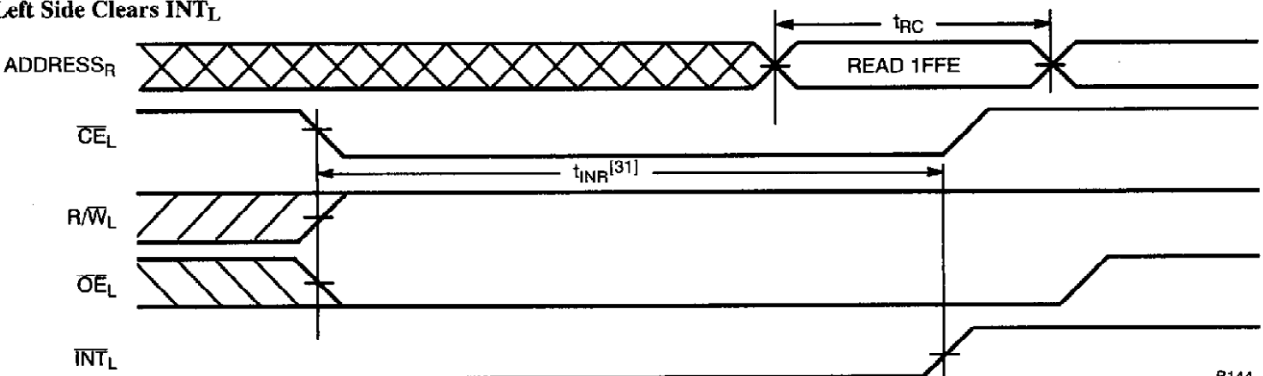

B144-26

## Architecture

The CY7B144/5 consists of an array of 8K words of 8/9 bits each of dual-port RAM cells, I/O and address lines, and control signals ( $\overline{CE}$ ,  $\overline{OE}$ ,  $R/\overline{W}$ ). These control pins permit independent access for reads or writes to any location in memory. To handle simultaneous writes/reads to the same location, a  $\overline{BUSY}$  pin is provided on each port. Two interrupt ( $\overline{INT}$ ) pins can be utilized for port-to-port communication. Two semaphore ( $\overline{SEM}$ ) control pins are used for allocating shared resources. With the  $M/\overline{S}$  pin, the CY7B144/5 can function as a Master ( $\overline{BUSY}$  pins are outputs) or as a slave ( $\overline{BUSY}$  pins are inputs). The CY7B144/5 has an automatic power-down feature controlled by  $\overline{CE}$ . Each port is provided with its own output enable control ( $\overline{OE}$ ), which allows data to be read from the device.

## Functional Description

### Write Operation

Data must be set up for a duration of  $t_{SD}$  before the rising edge of  $R/\overline{W}$  in order to guarantee a valid write. A write operation is controlled by either the  $\overline{OE}$  pin (see Write Cycle No. 1 waveform) or the  $R/\overline{W}$  pin (see Write Cycle No. 2 waveform). Data can be written to the device  $t_{HZOE}$  after the  $\overline{OE}$  is deasserted or  $t_{HZWE}$  after the falling edge of  $R/\overline{W}$ . Required inputs for non-contention operations are summarized in Table 1.

If a location is being written to by one port and the opposite port attempts to read that location, a port-to-port flowthrough delay must be met before the data is read on the output; otherwise the data read is not deterministic. Data will be valid on the port  $t_{DD}$  after the data is presented on the other port.

### Read Operation

When reading the device, the user must assert both the  $\overline{OE}$  and  $\overline{CE}$  pins. Data will be available  $t_{ACE}$  after  $\overline{CE}$  or  $t_{DOE}$  after  $\overline{OE}$  are asserted. If the user of the CY7B144/5 wishes to access a semaphore flag, then the  $\overline{SEM}$  pin must be asserted instead of the  $\overline{CE}$  pin.

### Interrupts

The interrupt flag ( $\overline{INT}$ ) permits communications between ports. When the left port writes to location 1FFF, the right port's interrupt flag ( $\overline{INT}_R$ ) is set. This flag is cleared when the right port reads that same location. Setting the left port's interrupt flag ( $\overline{INT}_L$ ) is accomplished when the right port writes to location 1FFE. This flag is cleared when the left port reads location 1FFE. The message at 1FFF or 1FFE is user-defined. See Table 2 for input requirements for  $\overline{INT}_R$  and  $\overline{INT}_L$  are push-pull outputs and do not require pull-up resistors to operate.

### Busy

The CY7B144/5 provides on-chip arbitration to alleviate simultaneous memory location access (contention). If both ports'  $\overline{CE}$ s are asserted and an address match occurs within  $t_{PS}$  of each other the Busy logic will determine which port has access. If  $t_{PS}$  is violated, one port will definitely gain permission to the location, but it is not guaranteed which one.  $\overline{BUSY}$  will be asserted  $t_{BLA}$  after an address match or  $t_{BLC}$  after  $\overline{CE}$  is taken LOW.  $\overline{BUSY}_L$  and  $\overline{BUSY}_R$  in master mode are push-pull outputs and do not require pull-up resistors to operate.

### Master/Slave

An  $M/\overline{S}$  pin is provided in order to expand the word width by configuring the device as either a master or a slave. The  $\overline{BUSY}$  output of the master is connected to the  $\overline{BUSY}$  input of the slave. This will allow the device to interface to a master device with no external components. Writing of slave devices must be delayed until after the  $\overline{BUSY}$  input has settled. Otherwise, the slave chip may begin a write cycle during a contention situation. When presented a HIGH input, the  $M/\overline{S}$  pin allows the device to be used as a master and therefore the  $\overline{BUSY}$  line is an output.  $\overline{BUSY}$  can then be used to send the arbitration outcome to a slave.

### Semaphore Operation

The CY7B144/5 provides eight semaphore latches which are separate from the dual-port memory locations. Semaphores are used to reserve resources that are shared between the two ports. The state of the semaphore indicates that a resource is in use. For example, if the left port wants to request a given resource, it sets a latch by writing a 0 to a semaphore location. The left port then verifies its success in setting the latch by reading it. After writing to the semaphore,  $\overline{SEM}$  or  $\overline{OE}$  must be deasserted for  $t_{SOP}$  before attempting to read the semaphore. The semaphore value will be available  $t_{SWRD} + t_{DOE}$  after the rising edge of the semaphore write. If the left port was successful (reads a 0), it assumes control over the shared resource, otherwise (reads a 1) it assumes the right port has control and continues to poll the semaphore. When the right side has relinquished control of the semaphore (by writing a 1), the left side will succeed in gaining control of the semaphore. If the left side no longer requires the semaphore, a 1 is written to cancel its request.

Semaphores are accessed by asserting  $\overline{SEM}$  LOW. The  $\overline{SEM}$  pin functions as a chip enable for the semaphore latches ( $\overline{CE}$  must remain HIGH during  $\overline{SEM}$  LOW).  $A_0-2$  represents the semaphore address.  $\overline{OE}$  and  $R/\overline{W}$  are used in the same manner as a normal memory access. When writing or reading a semaphore, the other address pins have no effect.

When writing to the semaphore, only  $I/O_0$  is used. If a 0 is written to the left port of an unused semaphore, a 1 will appear at the same semaphore address on the right port. That semaphore can now only be modified by the side showing 0 (the left port in this case). If the left port now relinquishes control by writing a 1 to the semaphore, the semaphore will be set to 1 for both sides. However, if the right port had requested the semaphore (written a 0) while the left port had control, the right port would immediately own the semaphore as soon as the left port released it. Table 3 shows sample semaphore operations.

When reading a semaphore, all eight data lines output the semaphore value. The read value is latched in an output register to prevent the semaphore from changing state during a write from the other port. If both ports attempt to access the semaphore within  $t_{PS}$  of each other, the semaphore will definitely be obtained by one side or the other, but there is no guarantee which side will control the semaphore.

Initialization of the semaphore is not automatic and must be reset during initialization program at power-up. All Semaphores on both sides should have a one written into them at initialization from both sides to assure that they will be free when needed.

**Table 1. Non-Contending Read/Write**

Inputs				Outputs	Operation
CE	R/W	OE	SEM	I/O <sub>0-7</sub>	
H	X	X	H	High Z	Power-Down
H	H	L	L	Data Out	Read Data in Semaphore
X	X	H	X	High Z	I/O Lines Disabled
H		X	L	Data In	Write to Semaphore
L	H	L	H	Data Out	Read
L	L	X	H	Data In	Write
L	X	X	L		Illegal Condition

**Table 2. Interrupt Operation Example (assumes  $\overline{\text{BUSY}}_L = \overline{\text{BUSY}}_R = \text{HIGH}$ )**

Function	Left Port					Right Port				
	R/W	CE	OE	A <sub>0-12</sub>	INT	R/W	CE	OE	A <sub>0-12</sub>	INT
Set Left INT	X	X	X	X	L	L	L	X	1FFE	X
Reset Left INT	X	L	L	1FFE	H	X	L	L	X	X
Set Right INT	L	L	X	1FFF	X	X	X	X	X	L
Reset Right INT	X	X	X	X	X	X	L	L	1FFF	H

**Table 3. Semaphore Operation Example**

Function	I/O <sub>0</sub> Left	I/O <sub>0</sub> Right	Status
No action	1	1	Semaphore free
Left port writes semaphore	0	1	Left port obtains semaphore
Right port writes 0 to semaphore	0	1	Right side is denied access
Left port writes 1 to semaphore	1	0	Right port is granted access to semaphore
Left port writes 0 to semaphore	1	0	No change. Left port is denied access
Right port writes 1 to semaphore	0	1	Left port obtains semaphore
Left port writes 1 to semaphore	1	1	No port accessing semaphore address
Right port writes 0 to semaphore	1	0	Right port obtains semaphore
Right port writes 1 to semaphore	1	1	No port accessing semaphore
Left port writes 0 to semaphore	0	1	Left port obtains semaphore
Left port writes 1 to semaphore	1	1	No port accessing semaphore

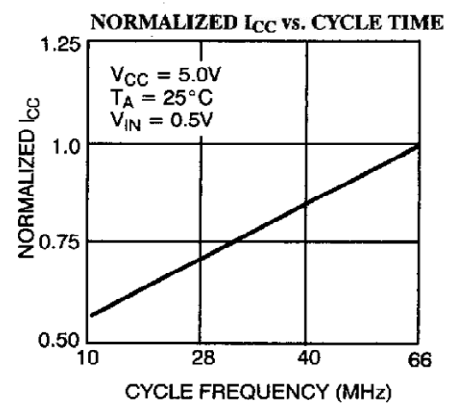
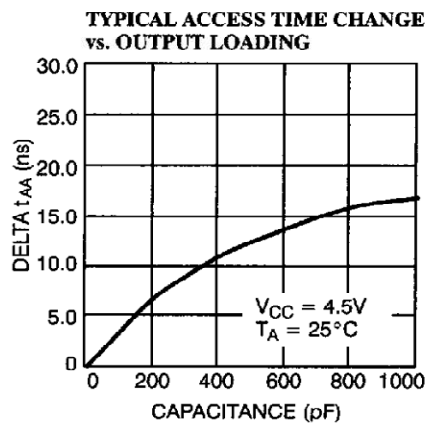
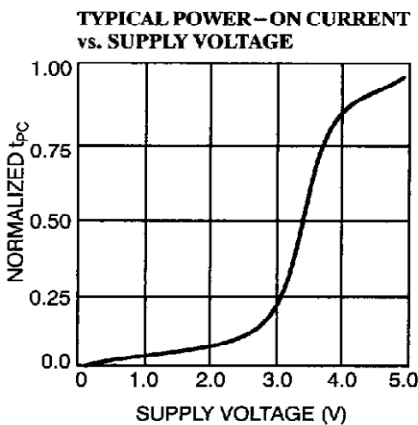
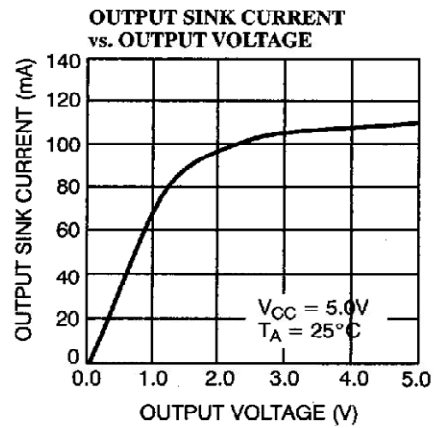
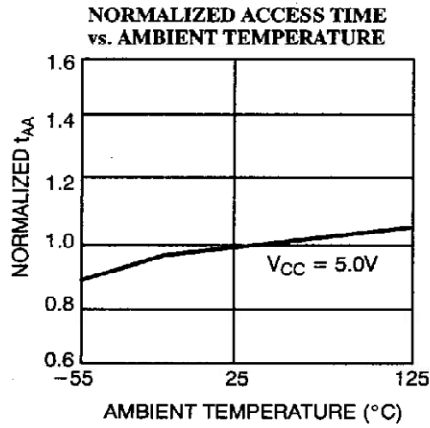
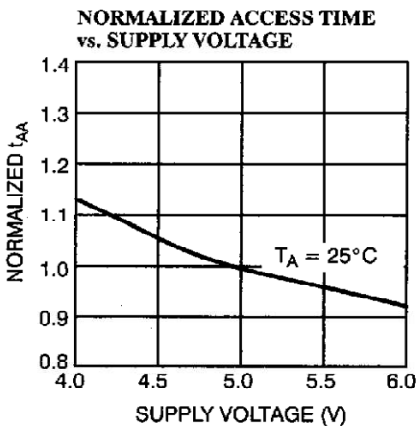
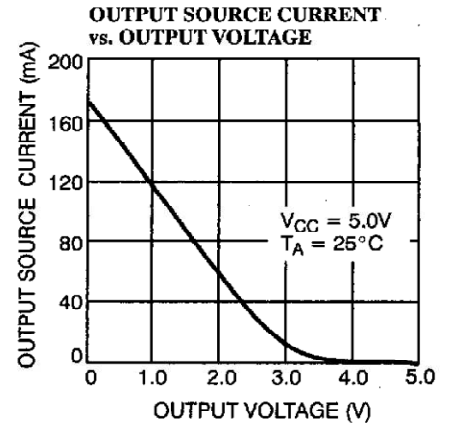
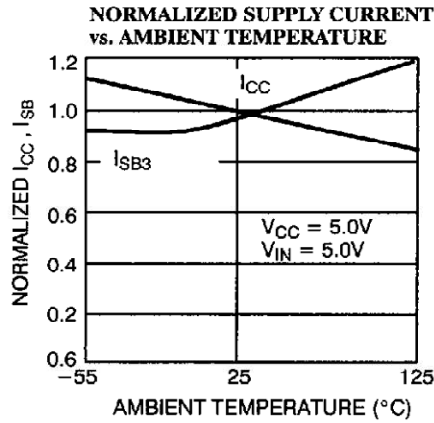
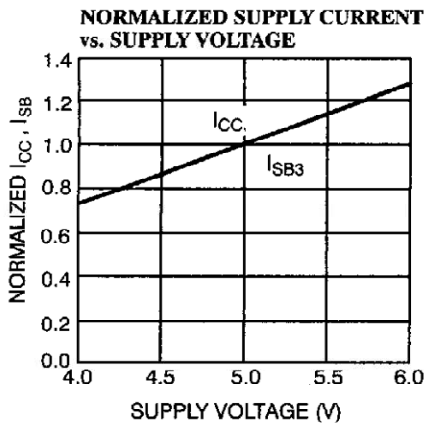
**Typical DC and AC Characteristics**



**Ordering Information**

Speed (ns)	Ordering Code	Package Name	Package Type	Operating Range
15	CY7B144-15AC	A65	64-Lead Thin Quad Flat Pack	Commercial
	CY7B144-15JC	J81	68-Lead Plastic Leaded Chip Carrier	
25	CY7B144-25AC	A65	64-Lead Thin Quad Flat Pack	Commercial
	CY7B144-25JC	J81	68-Lead Plastic Leaded Chip Carrier	
	CY7B144-25AI	A65	64-Lead Thin Quad Flat Pack	Industrial
	CY7B144-25JI	J81	68-Lead Plastic Leaded Chip Carrier	
	CY7B144-25LMB	L81	68-Square Leadless Chip Carrier	
35	CY7B144-35AC	A65	64-Lead Thin Quad Flat Pack	Commercial
	CY7B144-35JC	J81	68-Lead Plastic Leaded Chip Carrier	
	CY7B144-35AI	A65	64-Lead Thin Quad Flat Pack	Industrial
	CY7B144-35JI	J81	68-Lead Plastic Leaded Chip Carrier	
	CY7B144-35LMB	L81	68-Square Leadless Chip Carrier	
55	CY7B144-55AC	A65	64-Lead Thin Quad Flat Pack	Commercial
	CY7B144-55JC	J81	68-Lead Plastic Leaded Chip Carrier	
	CY7B144-55AI	A65	64-Lead Thin Quad Flat Pack	Industrial
	CY7B144-55JI	J81	68-Lead Plastic Leaded Chip Carrier	

Speed (ns)	Ordering Code	Package Name	Package Type	Operating Range
15	CY7B145-15AC	A80	80-Lead Thin Quad Flat Pack	Commercial
	CY7B145-15JC	J81	68-Lead Plastic Leaded Chip Carrier	
25	CY7B145-25AC	A80	80-Lead Thin Quad Flat Pack	Commercial
	CY7B145-25JC	J81	68-Lead Plastic Leaded Chip Carrier	
	CY7B145-25AI	A80	80-Lead Thin Quad Flat Pack	Industrial
	CY7B145-25JI	J81	68-Lead Plastic Leaded Chip Carrier	
	CY7B145-25LMB	L81	68-Square Leadless Chip Carrier	
35	CY7B145-35AC	A80	80-Lead Thin Quad Flat Pack	Commercial
	CY7B145-35JC	J81	68-Lead Plastic Leaded Chip Carrier	
	CY7B145-35AI	A80	80-Lead Thin Quad Flat Pack	Industrial
	CY7B145-35JI	J81	68-Lead Plastic Leaded Chip Carrier	
	CY7B145-35LMB	L81	68-Square Leadless Chip Carrier	
55	CY7B145-55AC	A80	80-Lead Thin Quad Flat Pack	Commercial
	CY7B145-55JC	J81	68-Lead Plastic Leaded Chip Carrier	
	CY7B145-55AI	A80	80-Lead Thin Quad Flat Pack	Industrial
	CY7B145-55JI	J81	68-Lead Plastic Leaded Chip Carrier	

**MILITARY SPECIFICATIONS  
Group A Subgroup Testing**
**DC Characteristics**

Parameters	Subgroups
V <sub>OH</sub>	1, 2, 3
V <sub>OL</sub>	1, 2, 3
V <sub>IH</sub>	1, 2, 3
V <sub>IL Max.</sub>	1, 2, 3
I <sub>Ix</sub>	1, 2, 3
I <sub>OZ</sub>	1, 2, 3
I <sub>CC</sub>	1, 2, 3
I <sub>SB1</sub>	1, 2, 3
I <sub>SB2</sub>	1, 2, 3
I <sub>SB3</sub>	1, 2, 3
I <sub>SB4</sub>	1, 2, 3

**Switching Characteristics**

Parameters	Subgroups
<b>READ CYCLE</b>	
t <sub>RC</sub>	7, 8, 9, 10, 11
t <sub>AA</sub>	7, 8, 9, 10, 11
t <sub>OHA</sub>	7, 8, 9, 10, 11
t <sub>ACE</sub>	7, 8, 9, 10, 11
t <sub>DOE</sub>	7, 8, 9, 10, 11
<b>WRITE CYCLE</b>	
t <sub>WC</sub>	7, 8, 9, 10, 11
t <sub>SCE</sub>	7, 8, 9, 10, 11
t <sub>AW</sub>	7, 8, 9, 10, 11
t <sub>HA</sub>	7, 8, 9, 10, 11
t <sub>SA</sub>	7, 8, 9, 10, 11
t <sub>PWE</sub>	7, 8, 9, 10, 11
t <sub>SD</sub>	7, 8, 9, 10, 11
t <sub>HD</sub>	7, 8, 9, 10, 11
<b>BUSY/INTERRUPT TIMING</b>	
t <sub>BLA</sub>	7, 8, 9, 10, 11
t <sub>BHA</sub>	7, 8, 9, 10, 11
t <sub>BLC</sub>	7, 8, 9, 10, 11
t <sub>BHC</sub>	7, 8, 9, 10, 11
t <sub>PS</sub>	7, 8, 9, 10, 11
t <sub>INS</sub>	7, 8, 9, 10, 11
t <sub>INR</sub>	7, 8, 9, 10, 11
<b>BUSY TIMING</b>	
t <sub>WB</sub>	7, 8, 9, 10, 11
t <sub>WH</sub>	7, 8, 9, 10, 11
t <sub>BDD</sub>	7, 8, 9, 10, 11
t <sub>DDD</sub>	7, 8, 9, 10, 11
t <sub>WDD</sub>	7, 8, 9, 10, 11

Document #: 38-00163-G