HA12141NT, HA12142NT, HA12170NT, HA12161FP, HA12162FP

Dolby B- and C-Type Noise Reduction System

HITACHI

ADE-207-036B (Z)

3rd Edition
Jun. 1999

Description

HA12141/142NT, HA12170NT, HA12161/162FP are silicon monolithic bipolar IC series providing dual channel Dolby B- and C-type noise reduction* in one chip.

Functions

- Dual Dolby B/C-type NR processor
- NR OFF/B/C control switch
- MPX by-pass / Encode / Decode (MPX OFF / REC / PB) control switch
- MPX Filter Drive Circuit

Features

- Low external parts count
- R-C spectrum skewing network using passive component
- External capacitors are E-3 series (small values)
- Several time constant capacitors built into the IC
- Separate REC/PB input and output. Unprocessed signal output available in the encode and decode modes.
- Common PCB pattern is available with HA12134A series (Dolby B NR), because these ICs offer similar pin layout.
- 3 type PB-out level (300 mV, 580 mV, 775 mV)
- 2 type package (DP-30S, FP-28D)
- Wide range of operating supply voltage (7.5 V to 16 V)

* Dolby is a trademark of Dolby Laboratories Licensing Corporation.
A license from Dolby Laboratories Licensing Corporation is required for the use of this IC.

HA12141NT, HA12142NT, HA12170NT, HA12161FP, HA12162FP

Ordering Information

Type No.	Package	Dolby Level	PB-OUT Level	REC-OUT Level	Remark
HA12141NT	DP-30S	300 m Vrms	300 m Vrms	300 m Vrms	—
HA12142NT	DP-30S	300 m Vrms	580 m Vrms	300 m Vrms	—
HA12170NT	DP-30S	300 m Vrms	775 m Vrms	300 m Vrms	—
HA12161FP	FP-28D	300 m Vrms	300 m Vrms	—	PB-mode only
HA12162FP	FP-28D	300 m Vrms	580 m Vrms	—	↓

Notes: 1. The common specifications are shown below.

REC-IN Level	PB-IN Level	IA-OUT Level (REC)	IA-OUT Level (PB)
42.9 mVrms	30.0 mVrms	429 mVrms	300 mVrms

2. The values listed above show approximate values to be offered Dolby Level at TP.

Absolute Maximum Ratings (Ta = 25°C, unless otherwise specified)

Item	Symbol	Rating	Unit	Note
Supply voltage	V _{cc} max	16	V	
Power dissipation	P _d	400	mW	Ta ≤ 85°C
Operating temperature	T _{opr}	-40 to +85	°C	
Storage temperature	T _{stg}	-55 to +125	°C	

HA12141NT, HA12142NT, HA12170NT, HA12161FP, HA12162FP

Electrical Characteristics (HA12141NT, HA12142NT, HA12170NT) (Ta = 25°C,

V_{CC} = Vopr-typ, unless otherwise specified)

(Dolby Level = 300 mVrms at TP (REC-mode: TP2, TP4 PB-mode: TP1, TP3))

Item	Symbol	Min	Typ	Max	Unit	Test conditions					
						R/P	NR	f (Hz)			
Operating voltage	HA12141NT	Vopr	7.5	12.0	16.0	V	—	—	—		
	HA12142NT		9.5	12.0	16.0	V					
	HA12170NT		12.0	14.0	16.0	V					
Quiescent current	I _{CC}	—	12.0	—	mA	R	OFF	—	No signal		
Input amp gain	Gv (IA REC)	18.0	20.0	22.0	dB	R	OFF	1 k	Vin = 0dB		
	Gv (IA PB)	18.0	20.0	22.0	dB	P	OFF	1 k			
B-type NR	B-ENC-2 k	2.8	4.3	5.8	dB	R	B	2 k	Vin = -20dB		
Encode boost	B-ENC-5 k	1.7	3.2	4.7	dB	R	B	5 k	Vin = -20dB		
C-Type NR	C-ENC-1 k (1)	3.9	5.9	7.9	dB	R	C	1 k	Vin = -20dB		
	Encode boost (2)	18.1	19.6	21.6	dB	R	C	1 k	Vin = -60dB		
	C-ENC-700	9.8	11.8	13.8	dB	R	C	700	Vin = -30dB		
Signal handling	HA12141NT	Vomax	12.0	13.0	—	dB	R	OFF	1 k	THD = 1%	V _{CC} = 7.5V
	HA12142NT		12.0	13.0	—	dB					V _{CC} = 9.5V
	HA12170NT		12.0	13.0	—	dB					V _{CC} = 12V

HA12141NT, HA12142NT, HA12170NT, HA12161FP, HA12162FP

Electrical Characteristics (Ta = 25°C, V_{cc} = Vopr-typ, unless otherwise specified)

(Dolby Level = 300 mVrms at TP (REC-mode: TP2, TP4 PB-mode: TP1, TP3)) (cont)

Item	Symbol	Min	Typ	Max	Unit	Test conditions				
						R/P	NR	f (Hz)		
Signal to noise ratio	S/N (REC)	60.0	64.0	—	dB	R	C	—	Rg = 5.1kΩ CCIR/ARM	
Total harmonic distortion	THD (OFF)	—	0.03	0.15	%	R	OFF	1 k	Vin = 0dB	
	THD (C)	—	0.09	0.3	%	R	C	1 k	Vin = 0dB	
NR OFF frequency response	FR-OFF	-3.0	0.0	+3.0	dB	P	OFF	100 k	Vin = 0dB	
Crosstalk between	CT (R→P)	—	80.0	—	dB	P	OFF	1 k	Vin = 0dB	
REC-PB	CT (P→R)	—	80.0	—	dB	R	OFF	1 k		
Crosstalk between channel	CT (L→R)	—	85.0	—	dB	R	OFF	1 k	Vin = 0dB	
	CT (R→L)	—	85.0	—	dB					
Control voltage for MPX OFF/REC/PB	Vcont (MPX)	V _{cc} -1	—	V _{cc}	V					
	Vcont (REC)	2.5	—	$\frac{V_{cc}}{2} + 0.5$	V					
	Vcont (PB)	0.0	—	0.4	V					
Control voltage for NR C/B OFF	Vcont (C)	$\frac{V_{cc}}{2} + 3$	—	V _{cc}	V					
	Vcont (B)	$\frac{V_{cc}}{2} - 0.5$	—	$\frac{V_{cc}}{2} + 0.5$	V					
	Vcont (OFF)	0.0	—	$\frac{V_{cc}}{2} - 3$	V					
PB-OUT level	HA12141NT	Vout	250	300	350	mVrms	R	OFF	1 k	Vin = 0dB
	HA12142NT		490	580	670	mVrms				
	HA12170NT		646	775	904	mVrms				
REC-OUT offset	Voffset	-70	0.0	70	mV	R	OFF →C	—	V _{cc} = 16V No signal	
Channel balance	ΔGv	-1.0	0.0	1.0	DB	R	OFF	1 k	Vin = 0dB	

HA12141NT, HA12142NT, HA12170NT, HA12161FP, HA12162FP

Electrical Characteristics (HA12161FP, HA12162FP) (Ta = 25°C, V_{cc} = 12 V, Unless otherwise specified)

(Dolby Level = 300 mVrms at TP (PB-mode: TP1, TP3))

Item	Symbol	Min	Typ	Max	Unit	Test conditions					
						P/AUX	NR	f (Hz)			
Operating voltage	HA12161FP	Vopr	7.5	12.0	16.0	V	—	—	—		
	HA12162FP		9.5	12.0	16.0	V					
Quiescent current	I _{cc}	—	12.0	—	mA	P	OFF	—	No signal		
Input amp gain	Gv	18.0	20.0	22.0	dB	AUX1	OFF	1 k	Vin = 0dB		
	Gv (IA PB)	18.0	20.0	22.0	dB	P	OFF	1 k			
B-type NR decode cut	B-DEC-2 k	-5.8	-4.3	-2.8	dB	P	B	2 k	Vout = -20dB		
C-Type NR decode cut	C-DEC-1 k	-7.9	-5.9	-3.9	dB	P	C	1 k	Vout = -20dB		
	C-DEC-1 k	-21.6	-19.6	-18.1	dB	P	C	1 k	Vout = -60dB		
Signal handling	HA12161FP	Vomax	12.0	13.0	—	dB	P	OFF	1 k	THD = 1%	V _{cc} = 7.5V
	HA12162FP		12.0	13.0	—	dB	V _{cc} = 9.5V				
Signal to noise ratio	S/N (PB)	70.0	76.0	—	dB	P	OFF	—	Rg = 10kΩ CCIR/ARM		
Total harmonic distortion	THD (OFF)	—	0.03	0.15	%	P	OFF	1 k	Vin = 0dB		
	THD (C)	—	0.09	0.3	%	P	C	1 k	Vin = 0dB		
NR OFF frequency response	FR-OFF	-4.0	-1.0	+3.0	dB	P	OFF	100 k	Vin = 0dB		
Crosstalk between AUX 1→PB	CT (AUX 1→PB)	—	80.0	—	dB	P	OFF	1 k	Vin = 0dB		
Crosstalk between channel	CT (L→R)	—	85.0	—	dB	P	OFF	1 k	Vin = 12dB		
	CT (R→L)	—	85.0	—	dB						

HA12141NT, HA12142NT, HA12170NT, HA12161FP, HA12162FP

Electrical Characteristics (HA12161FP, HA12162FP) ($T_a = 25^\circ\text{C}$, $V_{cc} = 12\text{ V}$, Unless otherwise specified)

(Dolby Level = 300 mVrms at TP (PB-mode: TP1, TP3)) (cont)

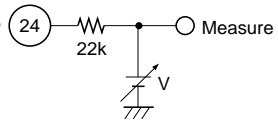
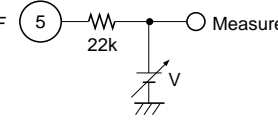
Item	Symbol	Min	Typ	Max	Unit	Test conditions			
						P/AUX NR	f (Hz)		
Control voltage for AUX 2/AUX 1/PB	Vcont (AUX 2)	$V_{cc}-1$	—	V_{cc}	V	A2/ A1/ P	24		
	Vcont (AUX 1)	2.5	—	$\frac{V_{cc}}{2} + 0.5$	V				
	Vcont (PB)	0.0	—	0.4	V				
Control voltage for NR C/B OFF	Vcont (C)	$\frac{V_{cc}}{2} + 3$	—	V_{cc}	V	C/ B/ OFF	5		
	Vcont (B)	$\frac{V_{cc}}{2} - 0.5$	—	$\frac{V_{cc}}{2} + 0.5$	V				
	Vcont (OFF)	0.0	—	$\frac{V_{cc}}{2} - 3$	V				
PB-OUT level	HA12161FP	Vout	250	300	350	mVrms	P	OFF 1 k	$V_{in} = 0\text{dB}$
	HA12162FP		490	580	670	mVrms			
PB-out offset	Voffset	-100	0.0	+100	mV	P	OFF →C	—	No signal
Channel balance	ΔG_v	-1.0	0.0	1.0	dB	P	OFF 1 k	$V_{in} = 0\text{dB}$	

HA12141NT, HA12142NT, HA12170NT, HA12161FP, HA12162FP

Block Diagram (HA12141NT, HA12142NT, HA12170NT)

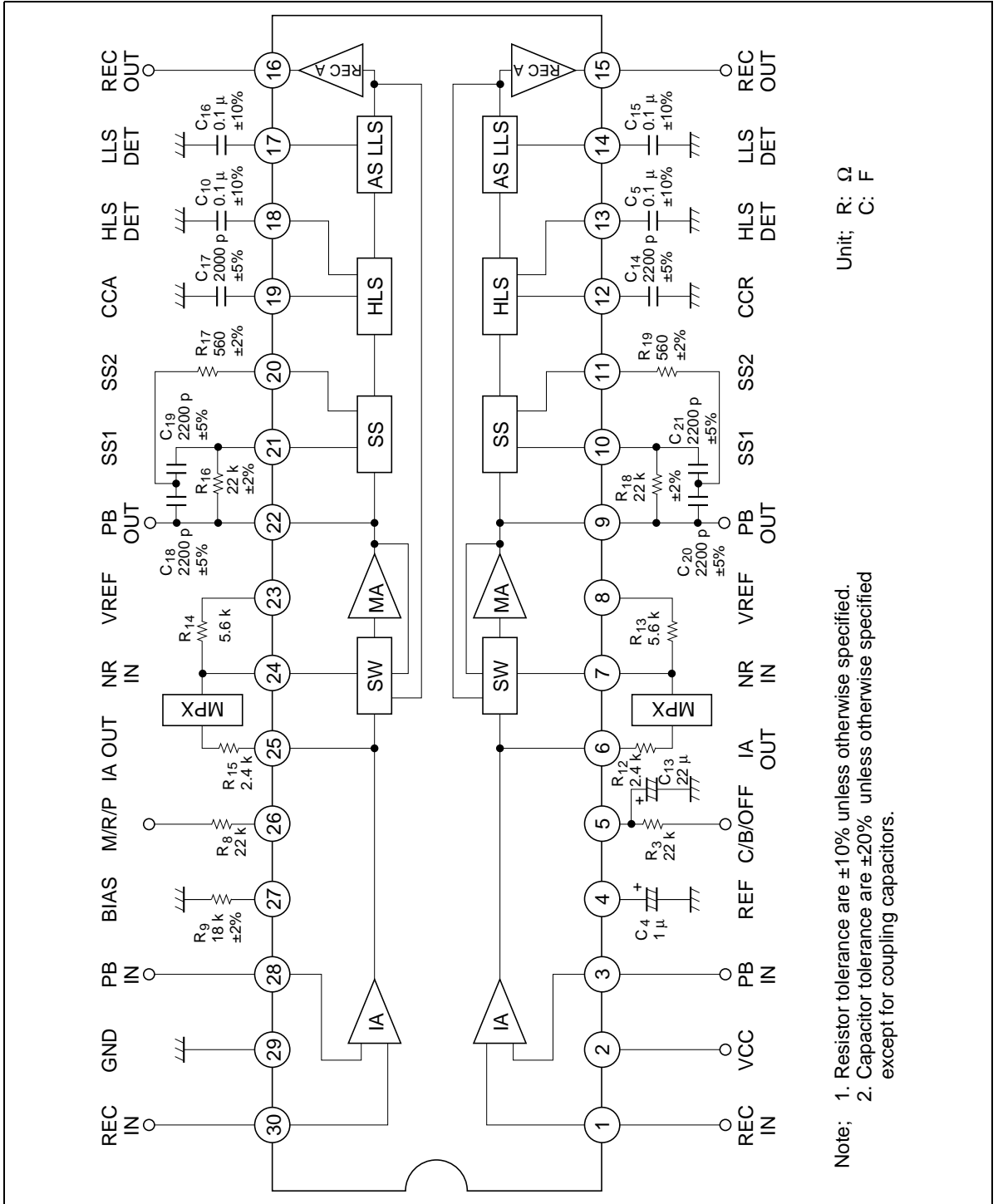

HA12141NT, HA12142NT, HA12170NT, HA12161FP, HA12162FP

Block Diagram (HA12161FP, HA12162FP)

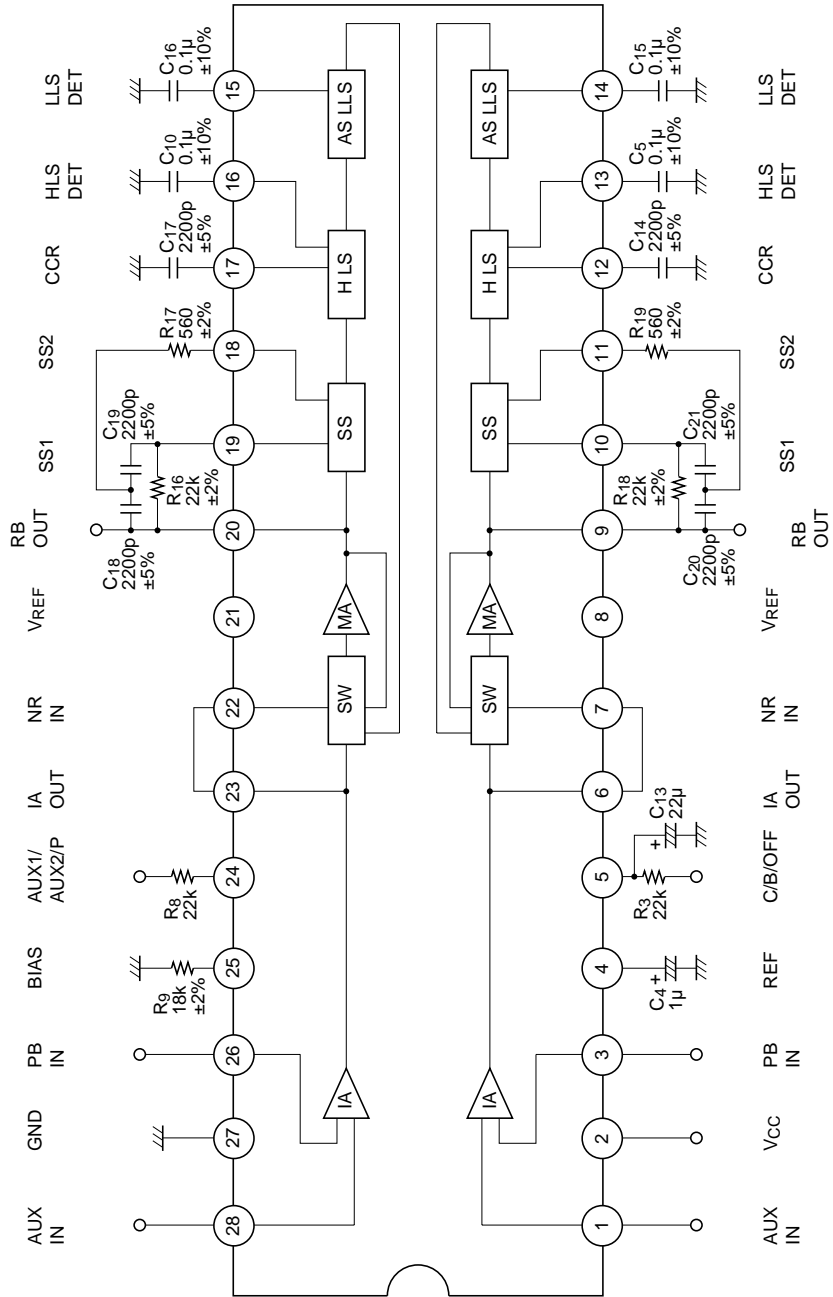

Unit R: Ω
C: F

- Notes: 1. Resistor tolerances are $\pm 10\%$ unless otherwise specified.
 2. Capacitor tolerances are $\pm 20\%$ unless otherwise specified except for coupling capacitors.

HA12141NT, HA12142NT, HA12170NT, HA12161FP, HA12162FP

Test Circuit (HA12141NT, HA12142NT, HA12170NT)

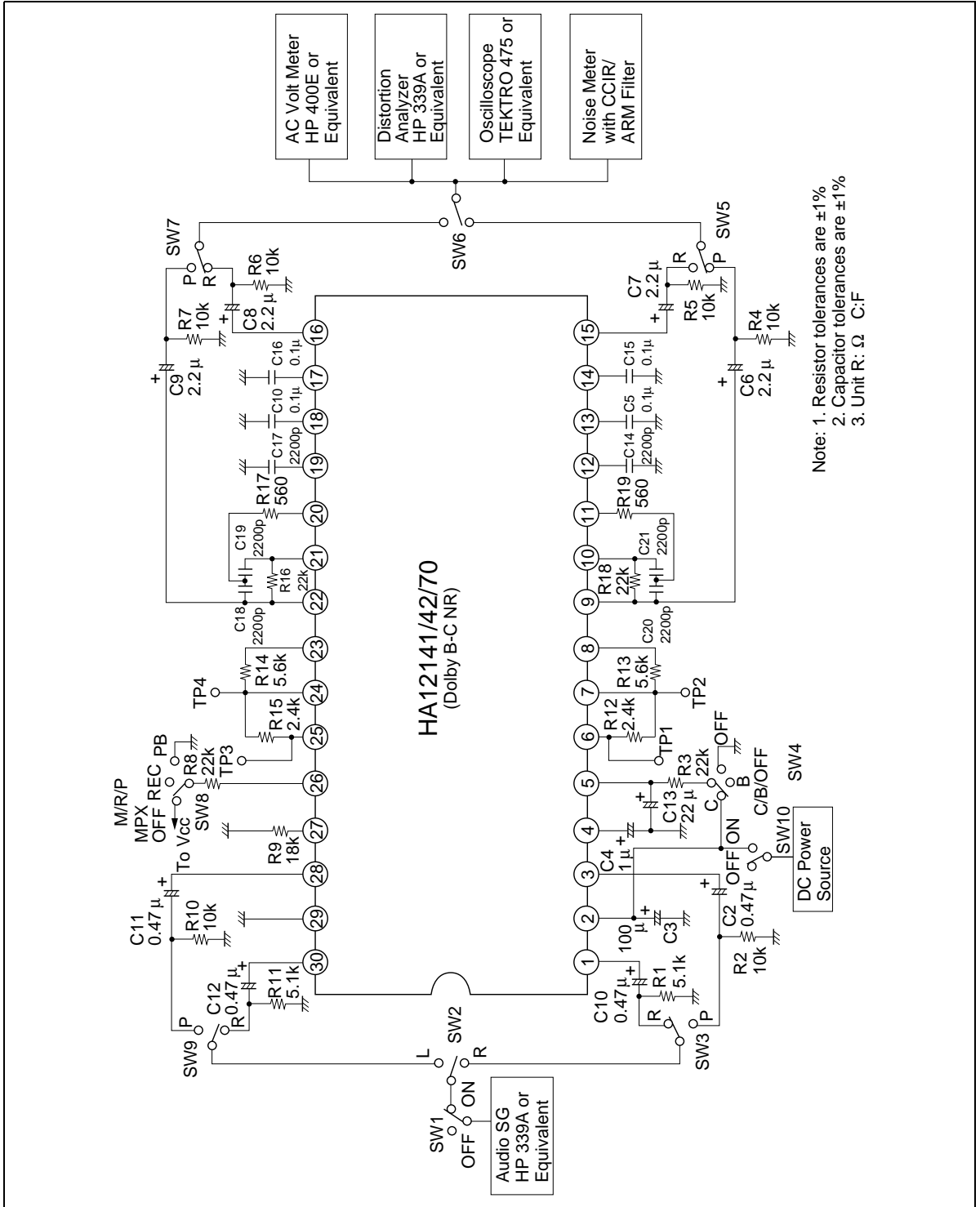

HA12141NT, HA12142NT, HA12170NT, HA12161FP, HA12162FP

Test Circuit (HA12161FP, HA12162FP)

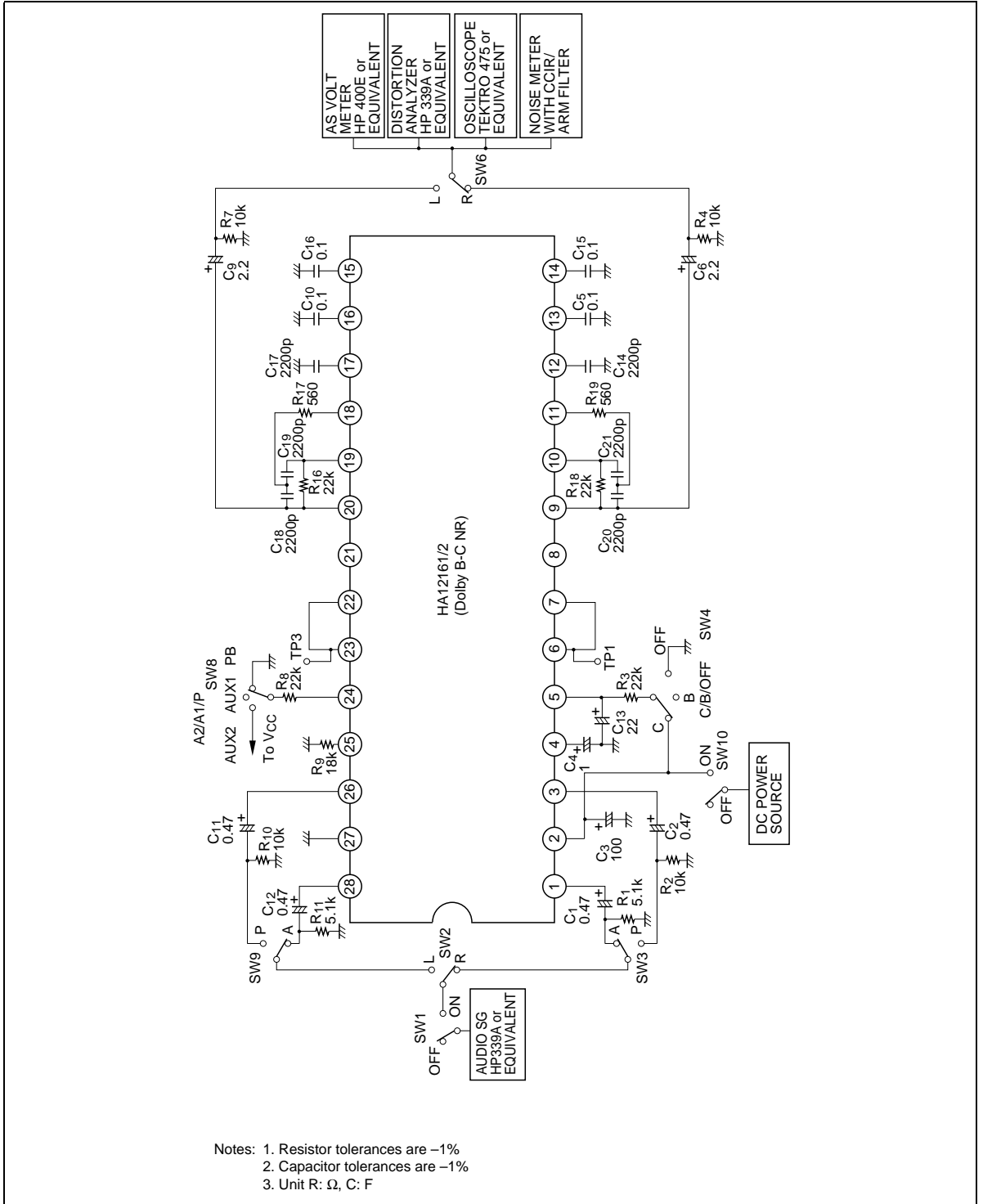

HA12141NT, HA12142NT, HA12170NT, HA12161FP, HA12162FP

Connection Diagram (HA12134A Series, HA12141 Series)

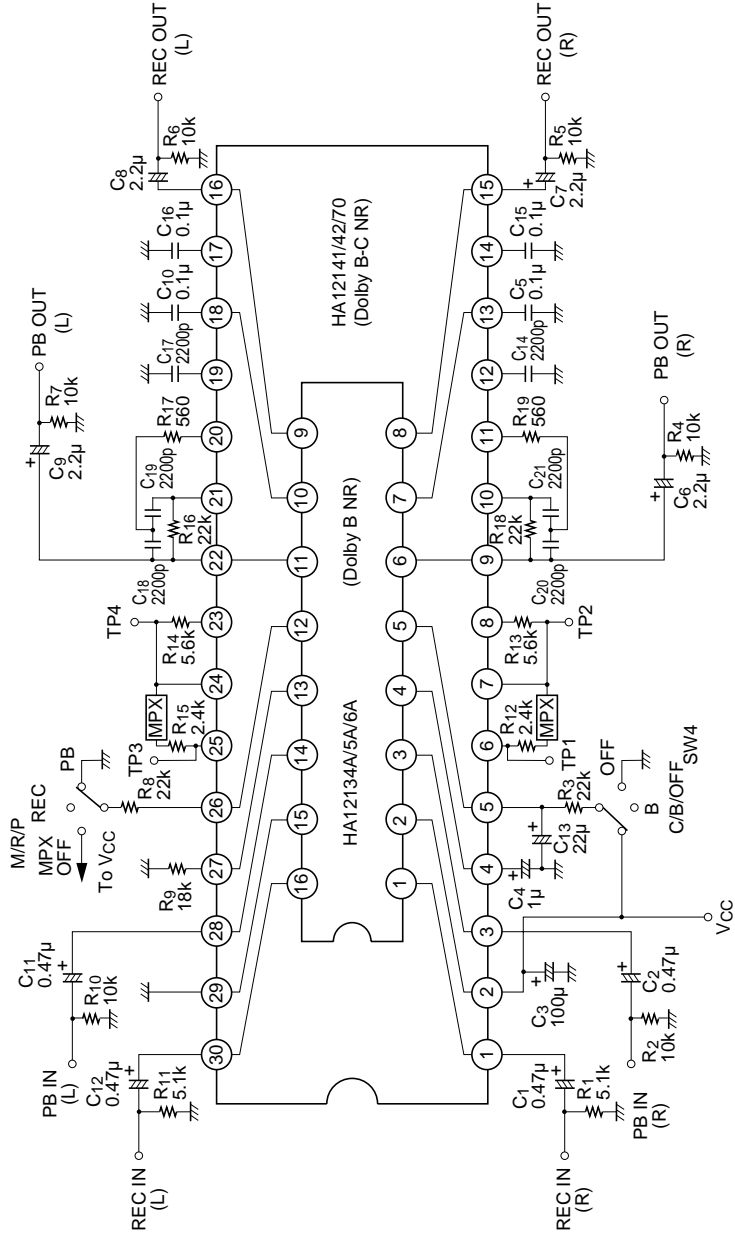

Note: C₅, C₁₀=0.22μF with HA12134A Series

HA12141NT, HA12142NT, HA12170NT, HA12161FP, HA12162FP

Pin Description ($V_{CC} = 12\text{ V}$, $T_a = 25^\circ\text{C}$, no signal, the value in the table show typical value.)

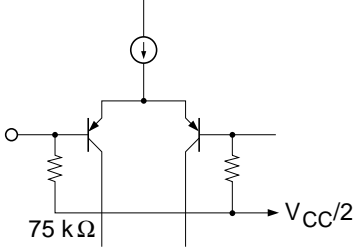
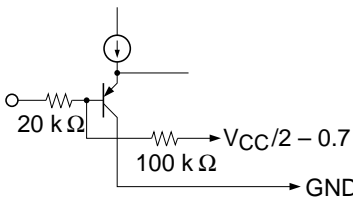
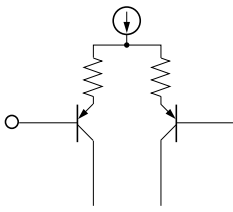
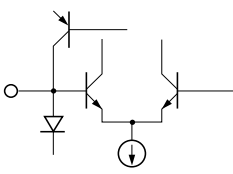
Pin No.	Terminal	DC				
DP	SOP	Name	Zin	Voltage	Equivalent circuit	Description
1	1	REC IN	75 k Ω	$V_{CC}/2$		Recording input
30	28					
3	3	PB IN				Playback input
28	26					
2	2	V_{CC}	—	V_{CC}	—	Power supply
4	4	REF	—	$V_{CC}/2$	—	Ripple filter
5	5	C/B/OFF	—	$V_{CC}/2 - 0.7\text{V}$		Mode control pin for NR "H" → C "M" → B "L" → NR OFF
7	7	NR IN	—	$V_{CC}/2$		NR processor input
24	22					
10	10	SS 1	—	$V_{CC}/2$		Spectral skewing amp input
21	19					

HA12141NT, HA12142NT, HA12170NT, HA12161FP, HA12162FP

Pin Description ($V_{CC} = 12\text{ V}$, $T_a = 25^\circ\text{C}$, no signal, the value in the table show typical value.) (cont)

Pin No.	Terminal	DC	Zin	Voltage	Equivalent circuit	Description
12	12	CCR	—	$V_{CC}/2$		Current controlled resistor output
19	17					
6	6	IA OUT	—	$V_{CC}/2$		Input amp. output
25	23					
8	8	VREF				Reference voltage output
23	21					
9	9	PB OUT				Playback (Decode) output
22	20					
11	11	SS 2				Spectral skewing amp. output
20	18					
15	—	REC				Recording (Encode) output
16	—	OUT				

HA12141NT, HA12142NT, HA12170NT, HA12161FP, HA12162FP

Pin Description ($V_{CC} = 12\text{ V}$, $T_a = 25^\circ\text{C}$, no signal, the value in the table show typical value.) (cont)

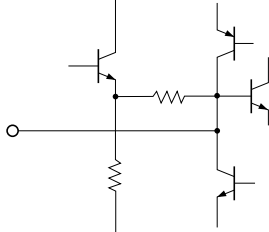
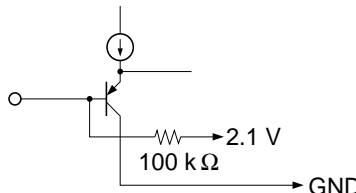
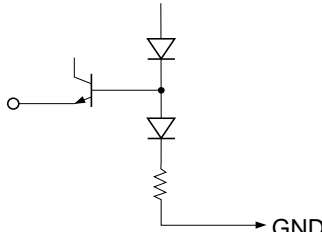
Pin No.		Terminal		DC	Equivalent circuit	Description
DP	SOP	Name	Zin	Voltage		
13	13	HLS DET	—	2.1 V		Time constant pin for rectifier
18	16					
14	14	LLS DET				
17	15					
26	24	M/R/P	—	2.1 V		Mode control pin for REC/PB "H" → REC MPX OFF "M" → REC MPX ON "L" → PB
27	25	BIAS	—	0.24 V		Reference current input
29	27	GND	—	0.0 V	—	Ground

HA12141NT, HA12142NT, HA12170NT, HA12161FP, HA12162FP

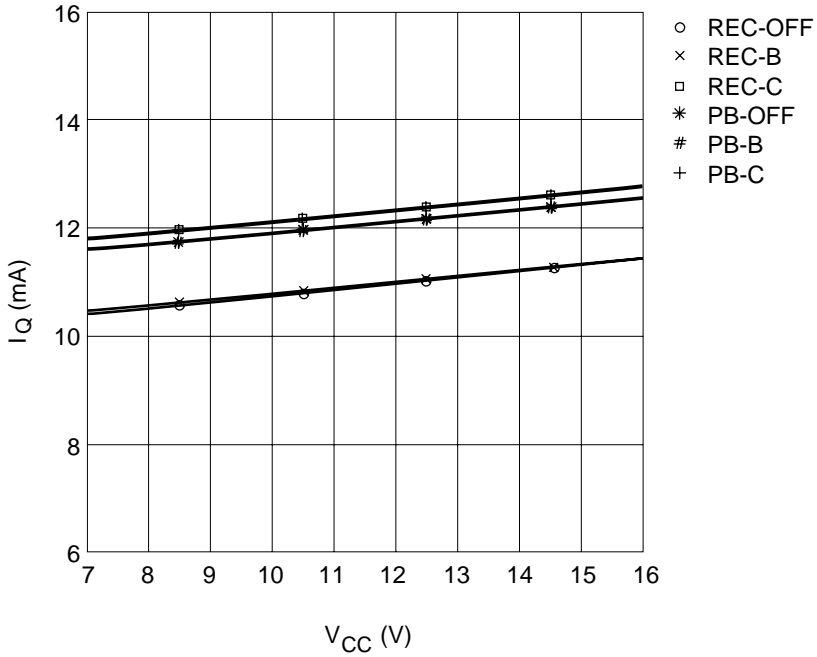

Quiescent Circuit vs. Supply Voltage

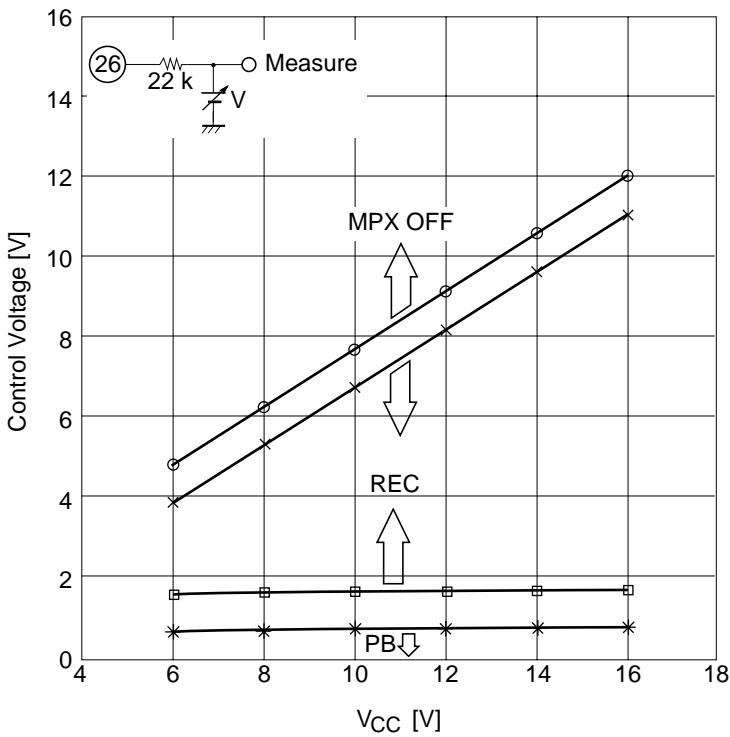

Control Voltage vs. Supply Voltage (PB/REC/MPX)

HA12141NT, HA12142NT, HA12170NT, HA12161FP, HA12162FP

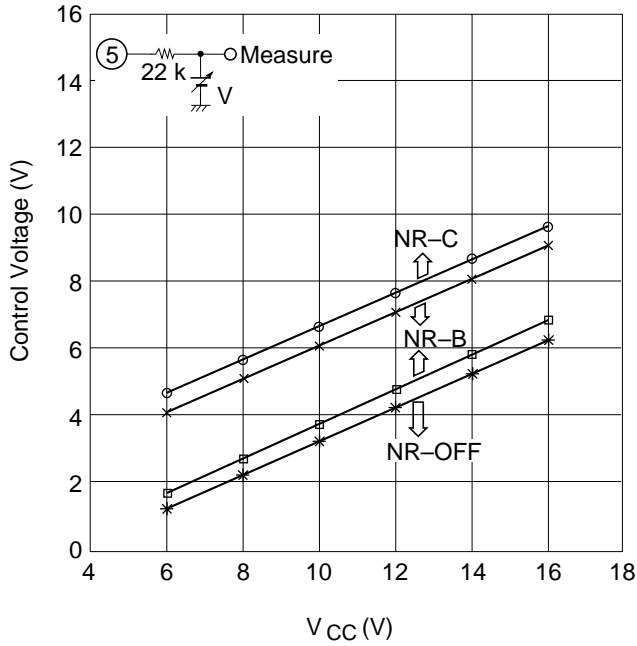

Control Voltage vs. Supply voltage (NR-OFF/B/C)

HA12141NT

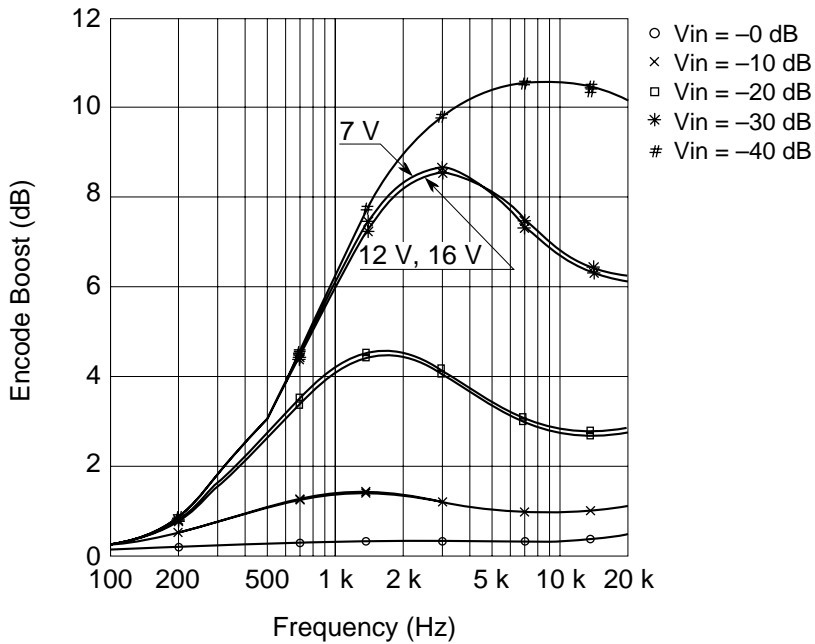

Encode Boost vs. Frequency (NR-B V_{CC} = 7V, 12 V, 16 V)

HA12141NT, HA12142NT, HA12170NT, HA12161FP, HA12162FP

HA12141NT

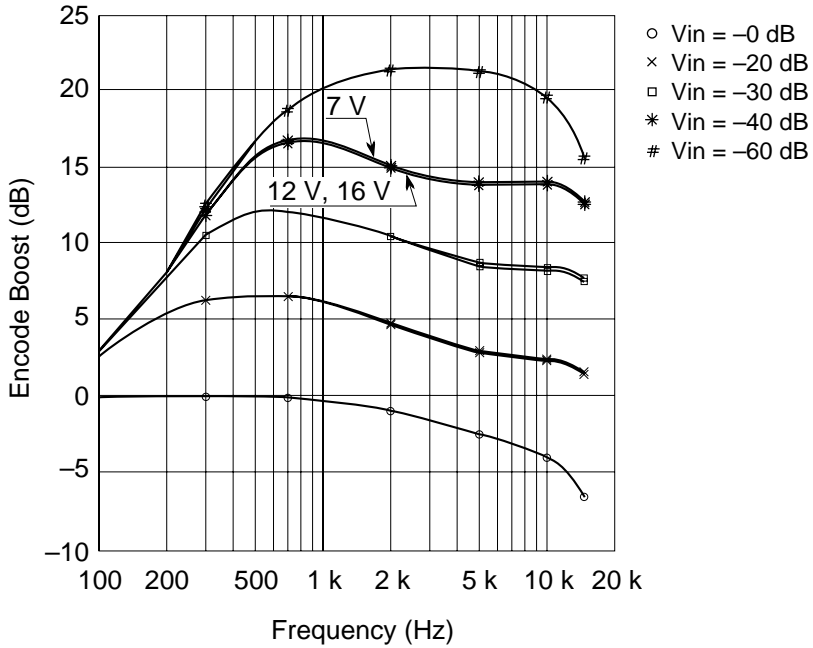

Encode Boost vs. Frequency (NR-C $V_{cc} = 7 \text{ V}, 12 \text{ V}, 16 \text{ V}$)

HA12141NT, HA12161FP

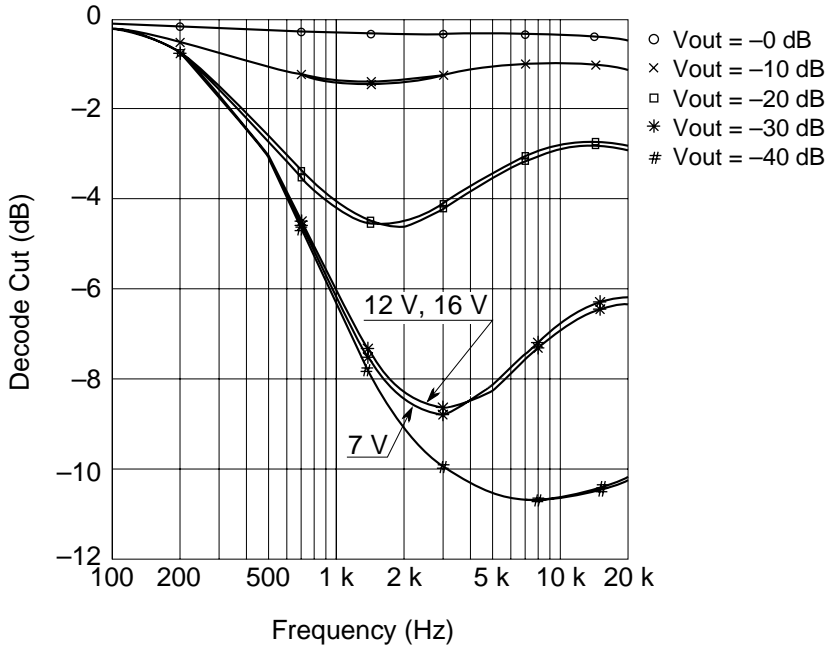

Decode Cut vs. Frequency (NR-B $V_{cc} = 7 \text{ V}, 12 \text{ V}, 16 \text{ V}$)

HA12141NT, HA12142NT, HA12170NT, HA12161FP, HA12162FP

HA12141NT, HA12161FP

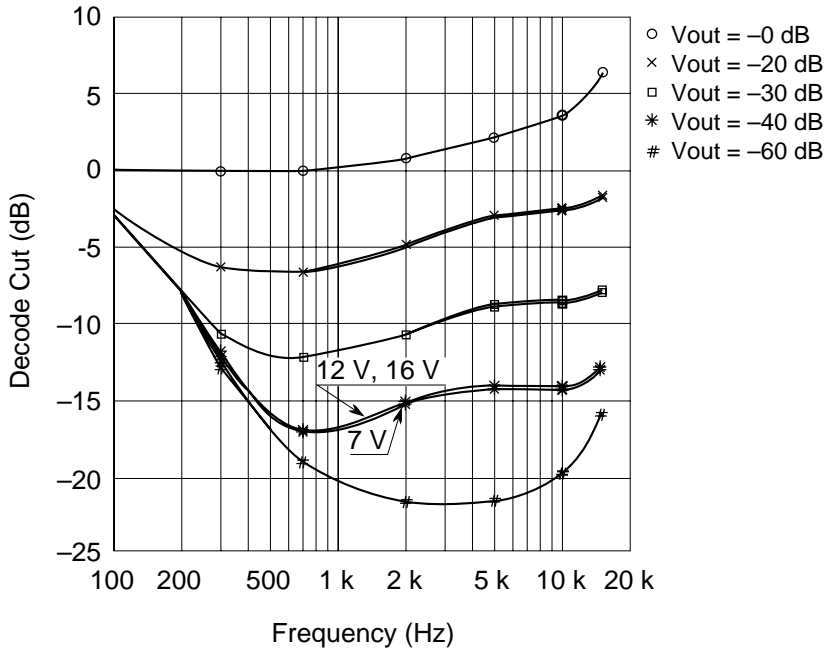

Decode Cut vs Frequency (NR-C $V_{cc} = 7\text{ V}, 12\text{ V}, 16\text{ V}$)

HA12141NT

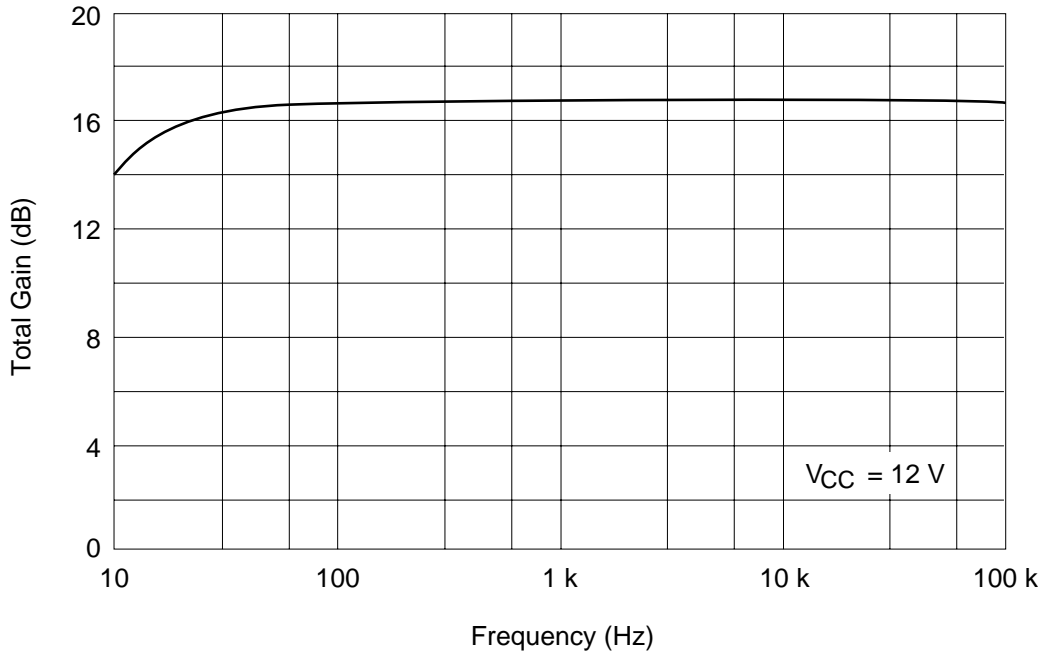

Total Gain vs. Frequency (REC MODE RECOUT NR-OFF)

HA12141NT, HA12142NT, HA12170NT, HA12161FP, HA12162FP

HA12141NT, HA12161FP

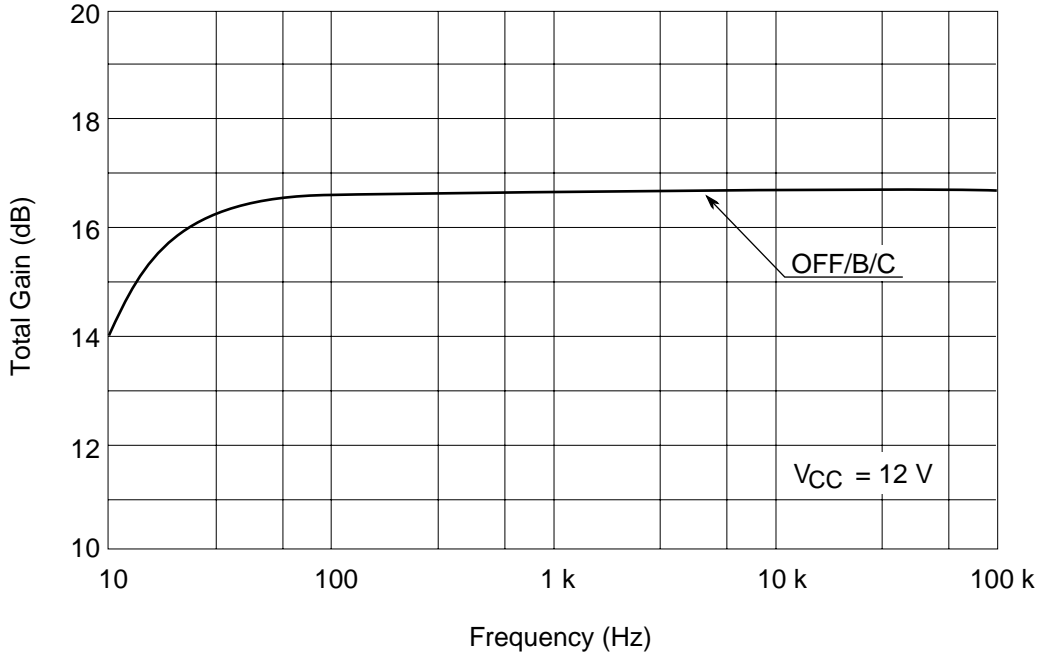

Total Gain vs. Frequency (REC MODE PBOUT)

HA12141NT

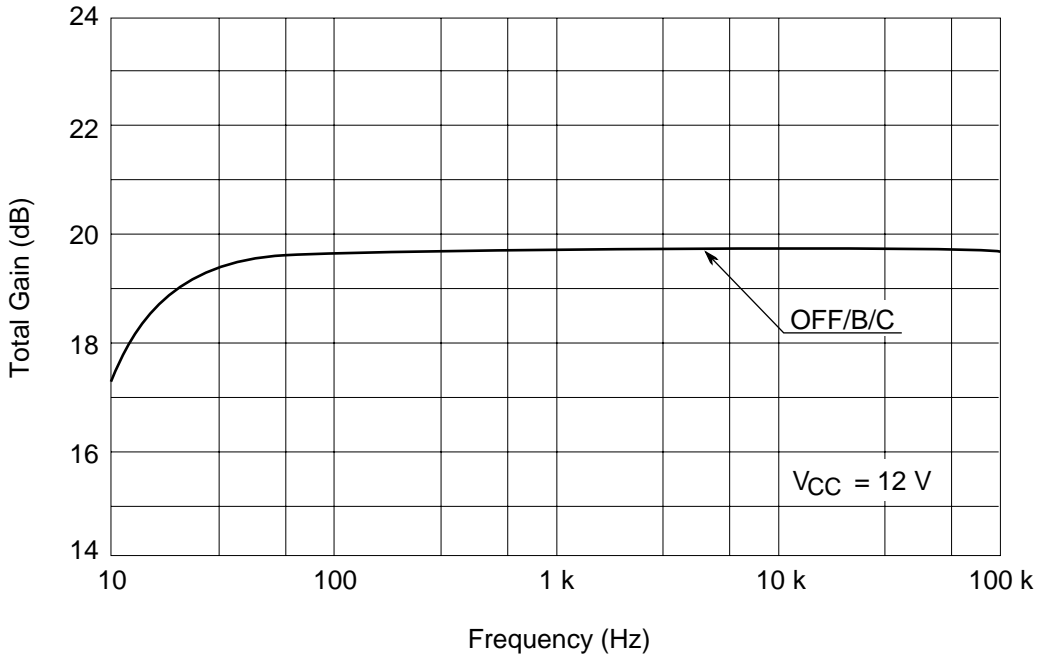

Total Gain vs. Frequency (PB MODE RECOUT)

HA12141NT, HA12142NT, HA12170NT, HA12161FP, HA12162FP

HA12141NT, HA12161FP

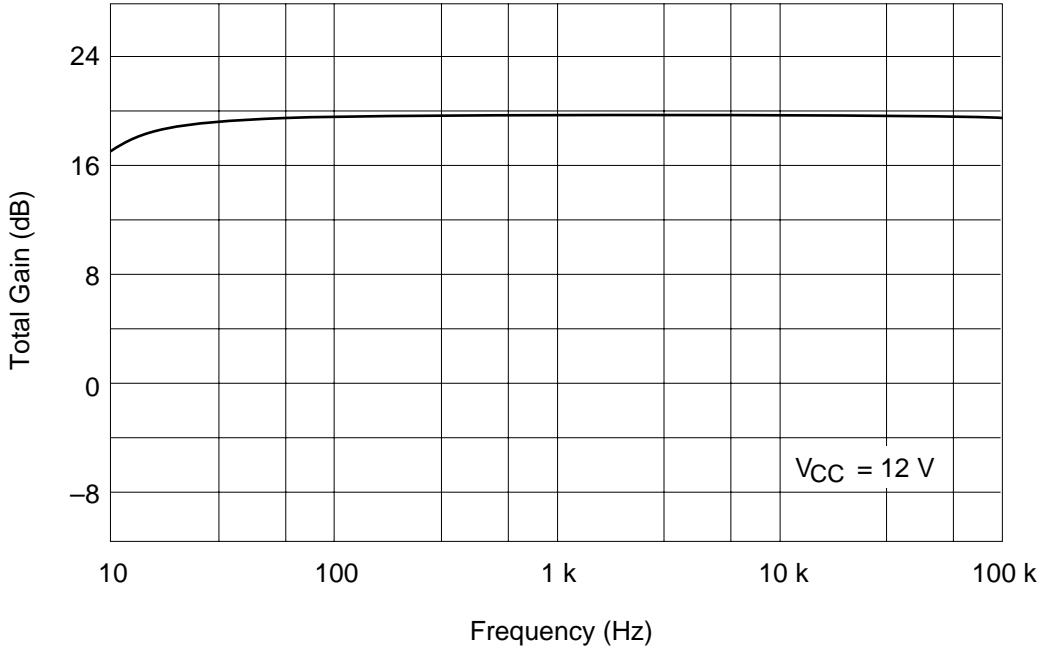

Total Gain vs. Frequency (PB MODE PBOUT NR-OFF)

HA12141NT

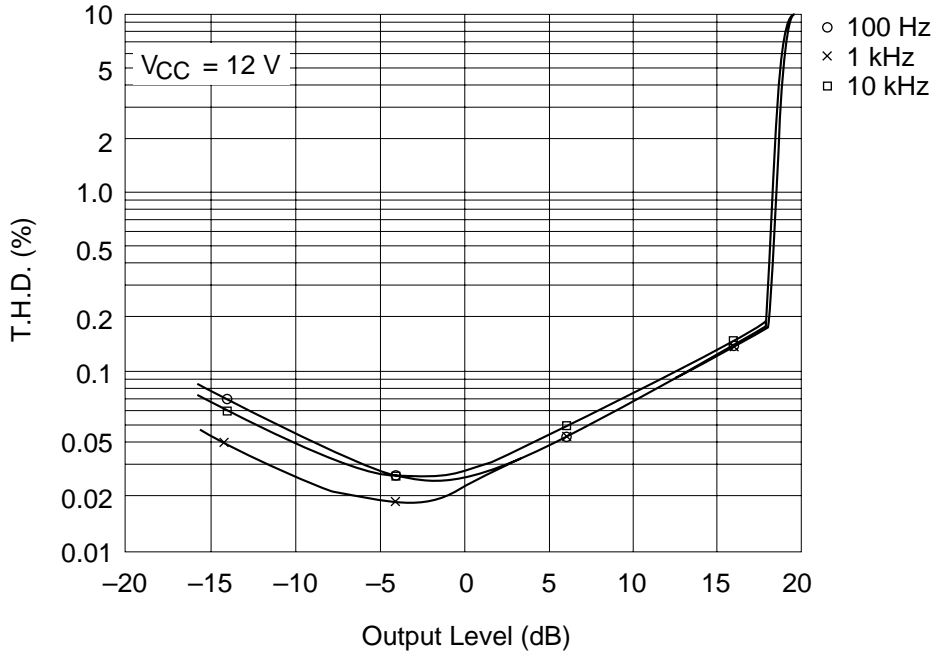

Total Harmonic Distortion vs. Output Level (REC MODE NR-OFF)

HA12141NT, HA12142NT, HA12170NT, HA12161FP, HA12162FP

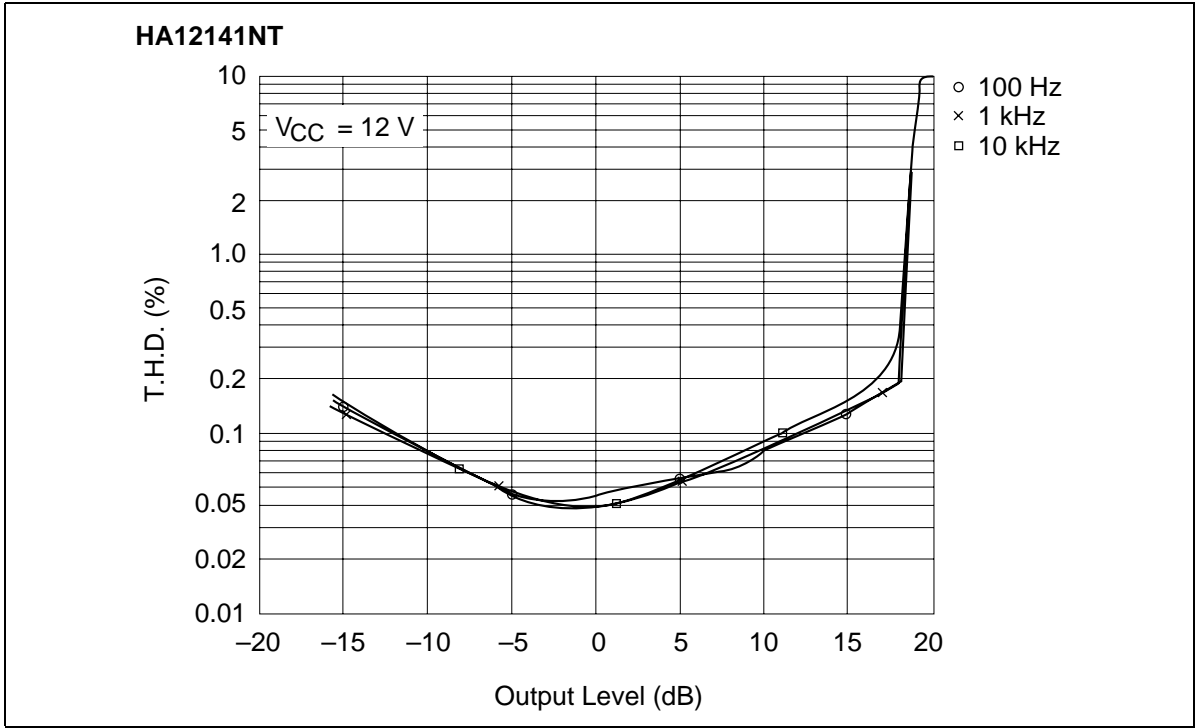

Total Harmonic Distortion vs. Output Level (REC MODE NR-B)

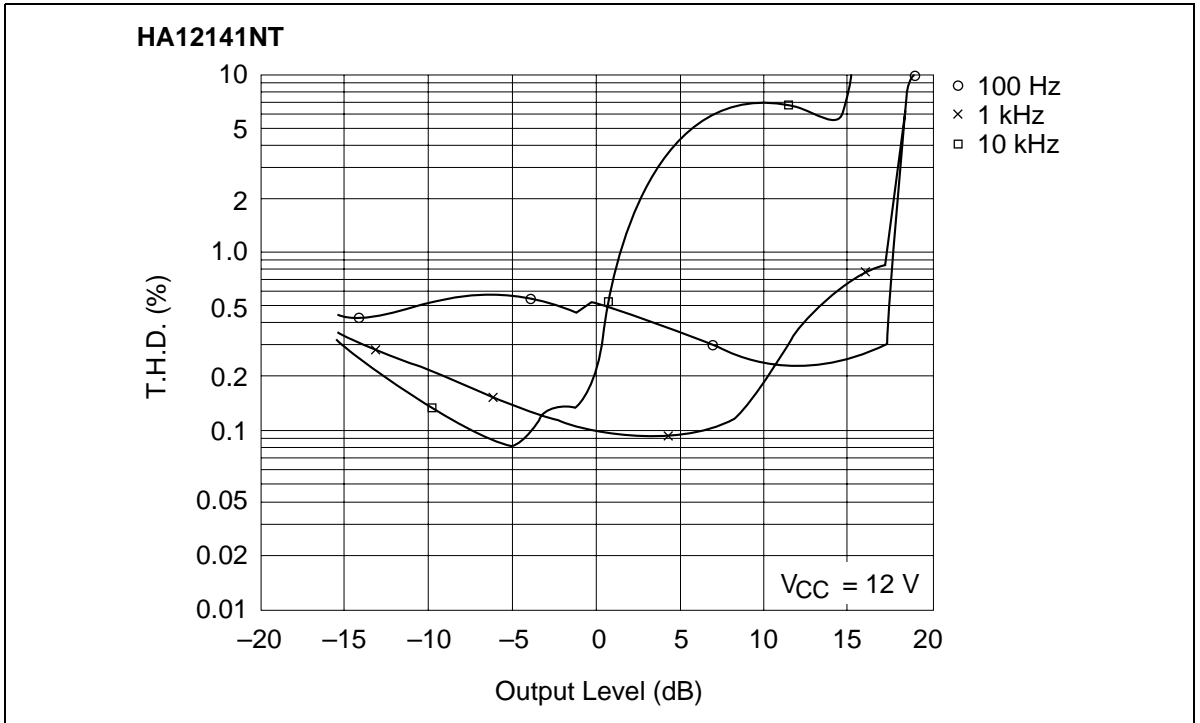

Total Harmonic Distortion vs. Output Level (REC MODE NR-C)

HA12141NT, HA12142NT, HA12170NT, HA12161FP, HA12162FP

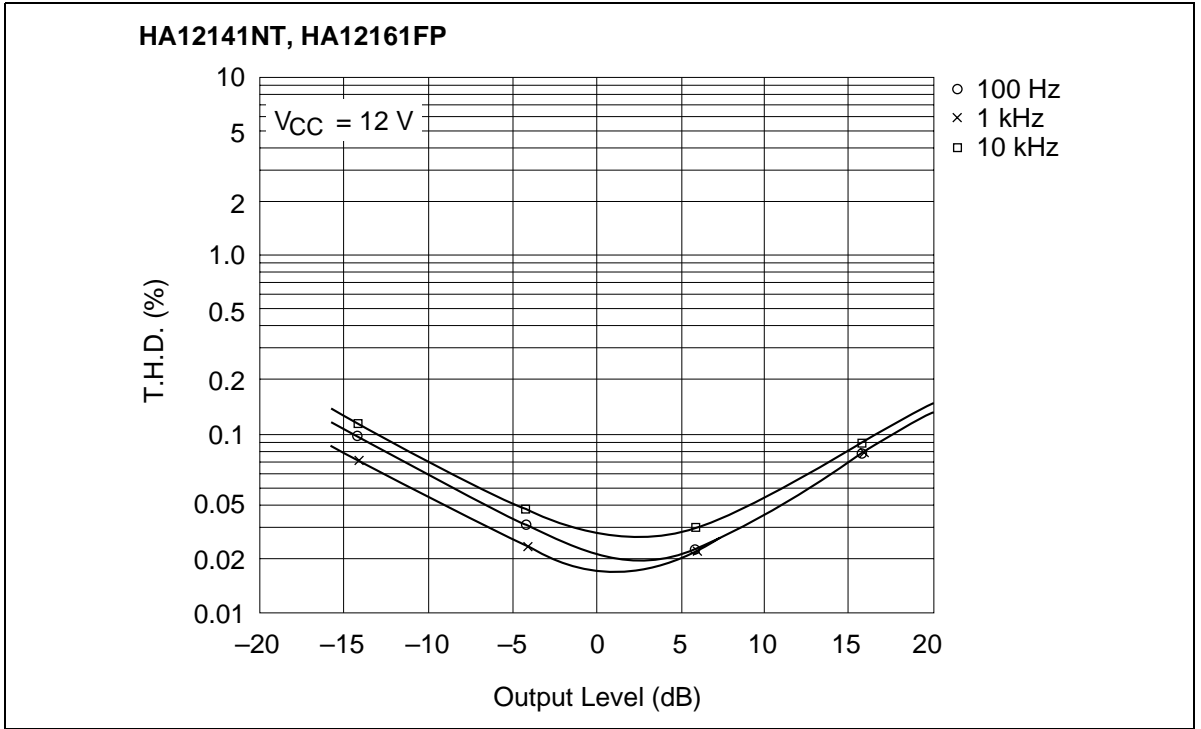

Total Harmonic Distortion vs. Output Level (PB MODE NR-OFF)

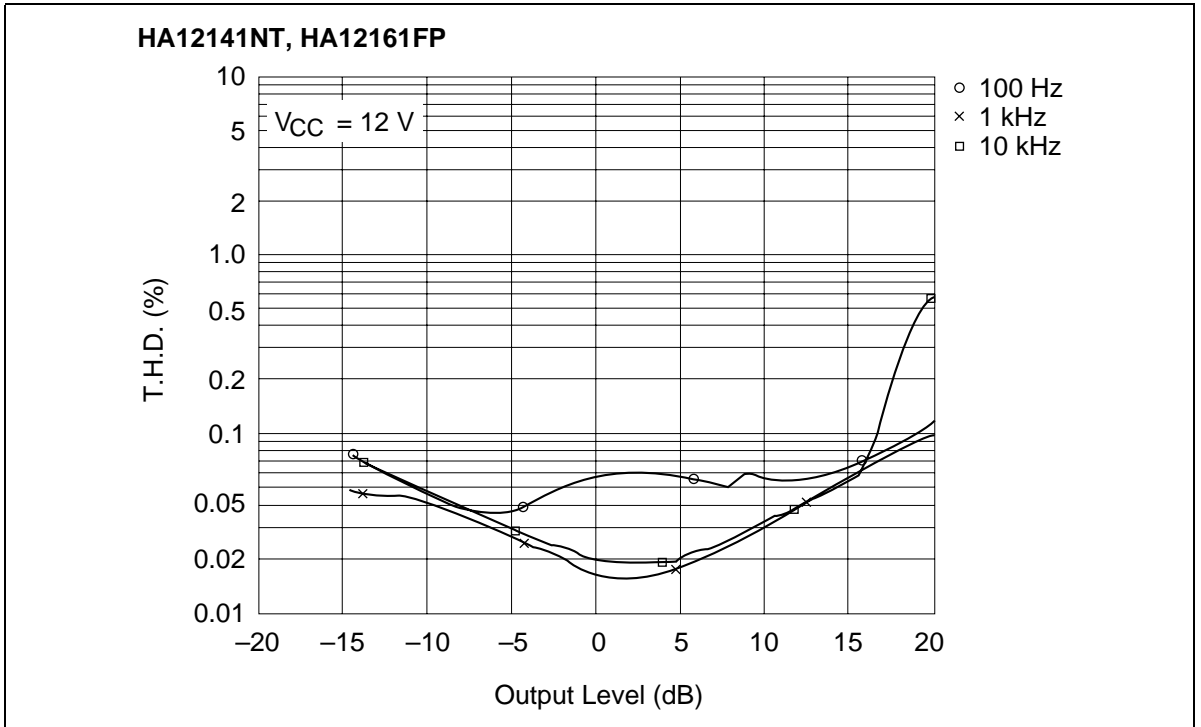

Total Harmonic Distortion vs. Output Level (PB MODE NR-B)

HA12141NT, HA12142NT, HA12170NT, HA12161FP, HA12162FP

HA12141NT, HA12161FP

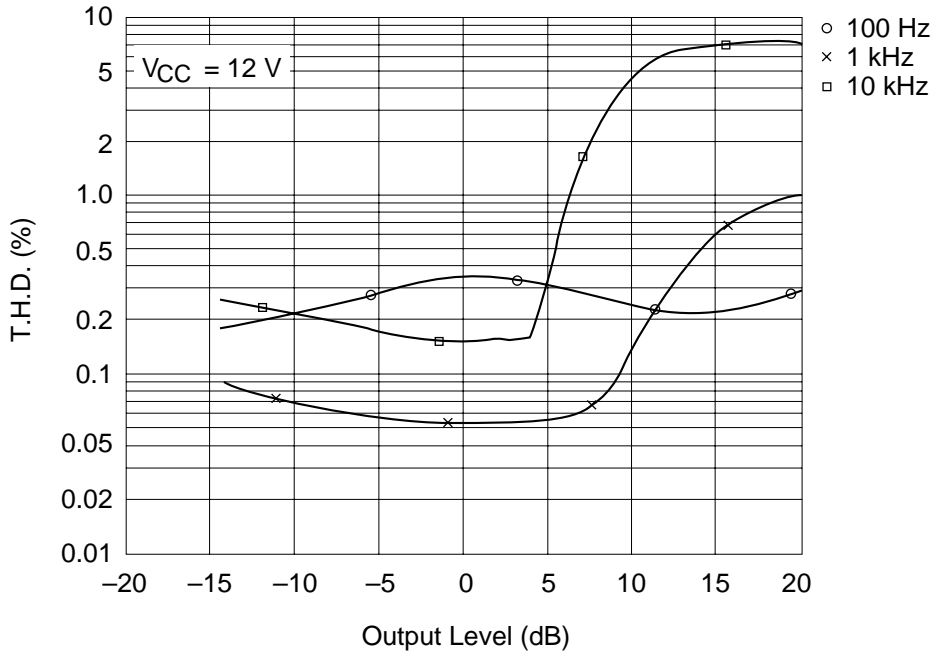

Total Harmonic Distortion vs. Output Level (PB MODE NR-C)

HA12141NT

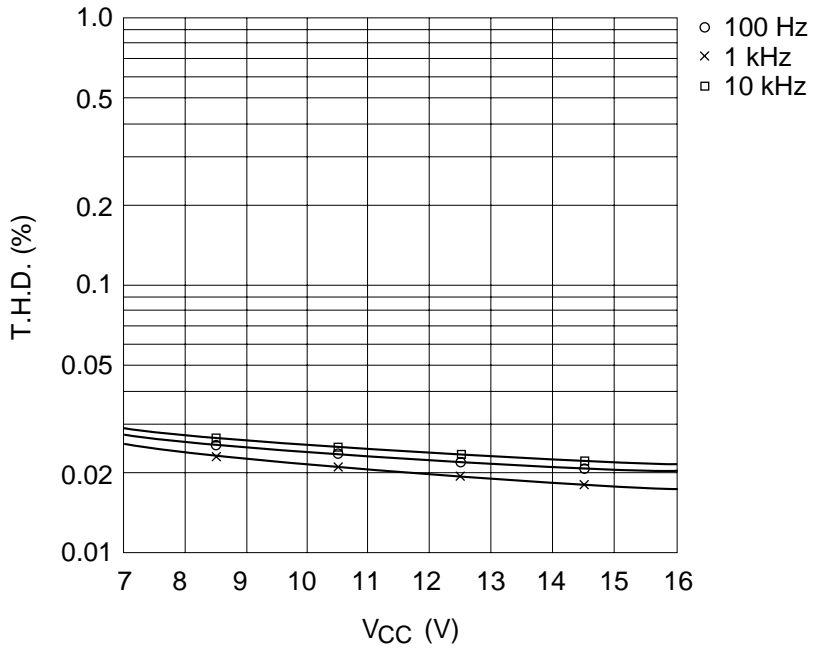

Total Harmonic Distortion vs. Supply Voltage (REC MODE NR-OFF)

HA12141NT, HA12142NT, HA12170NT, HA12161FP, HA12162FP

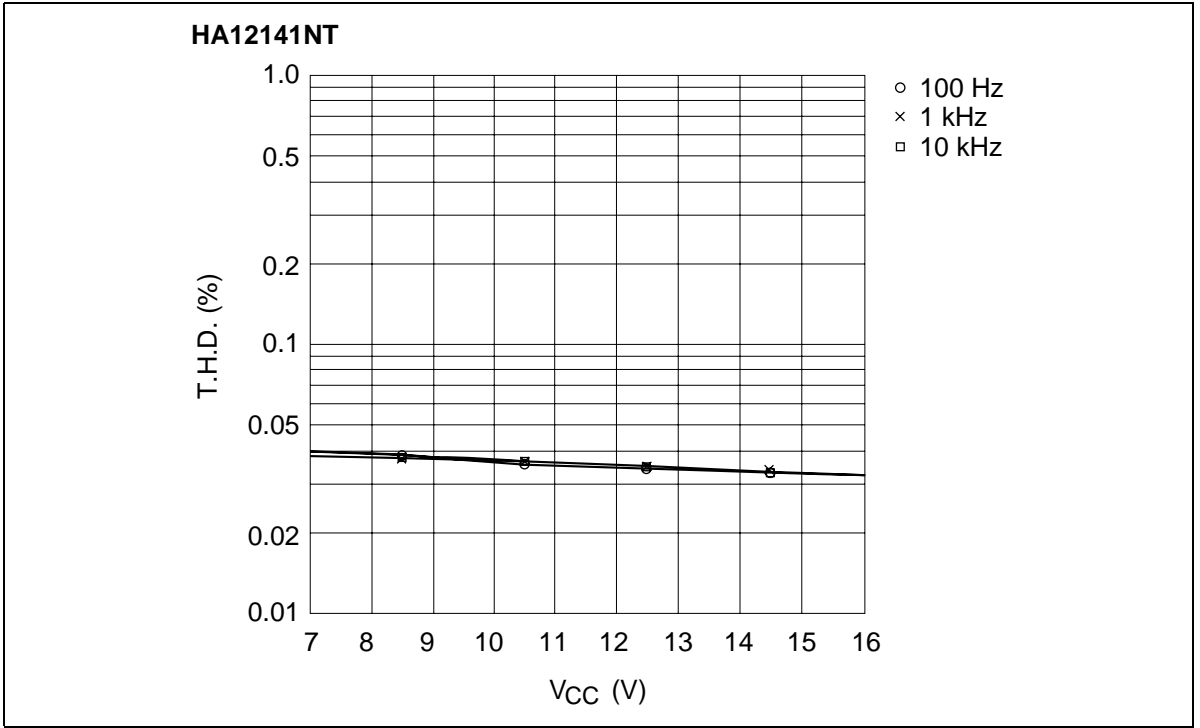

Total Harmonic Distortion vs. Supply Voltage (REC MODE NR-B)

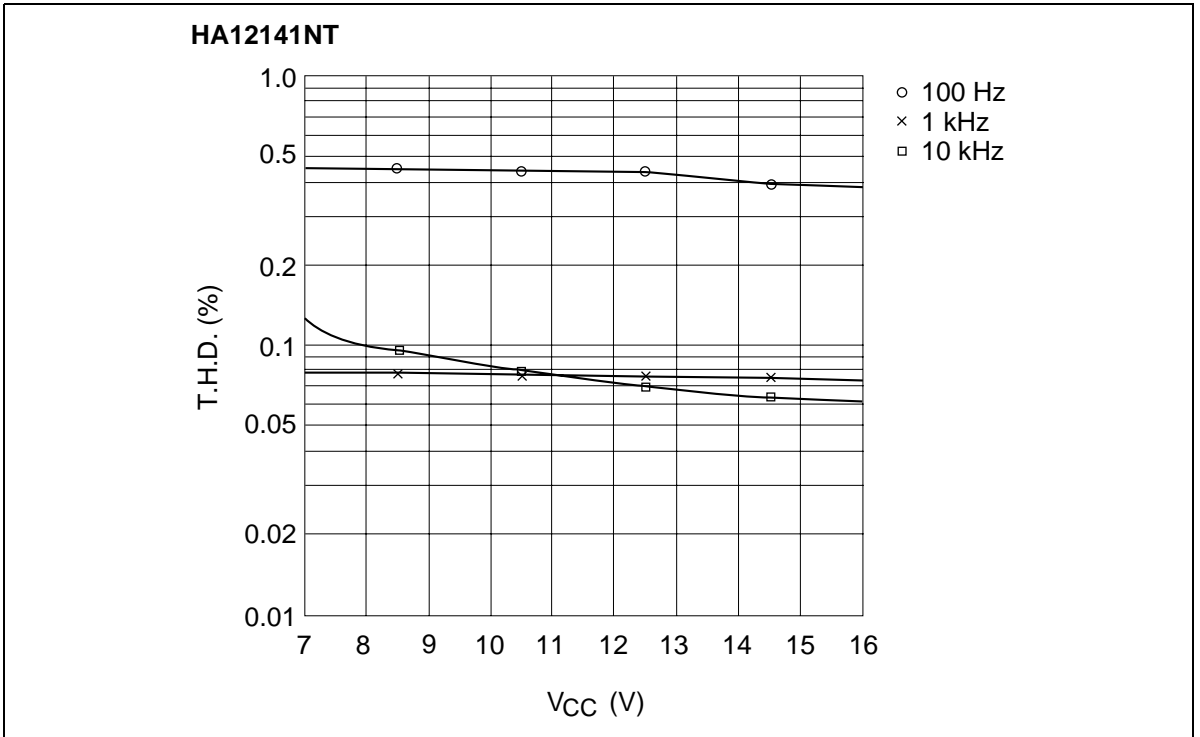

Total Harmonic Distortion vs. Supply Voltage (REC MODE NR-C)

HA12141NT, HA12142NT, HA12170NT, HA12161FP, HA12162FP

HA12141NT, HA12161FP

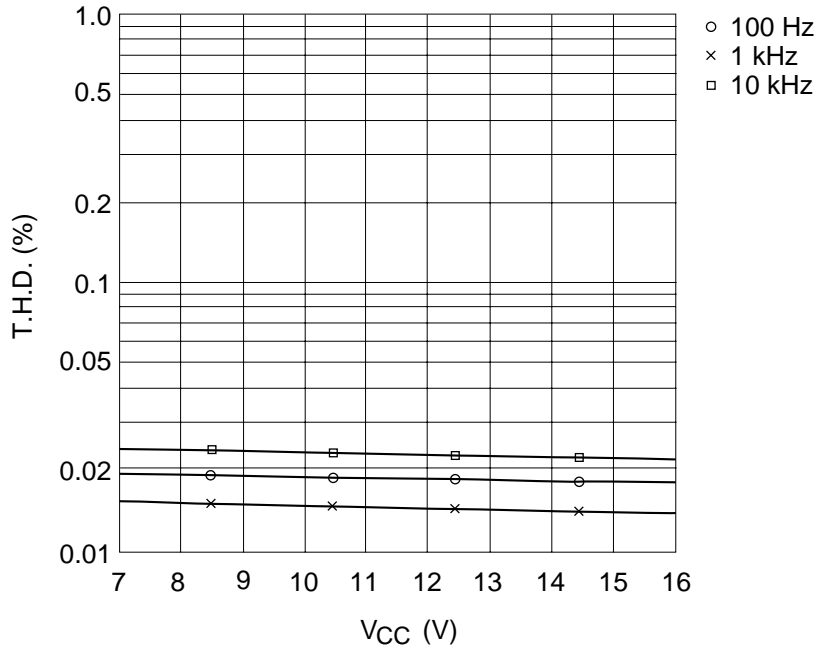

Total Harmonic Distortion vs. Supply Voltage (PB MODE NR-OFF)

HA12141NT, HA12161FP

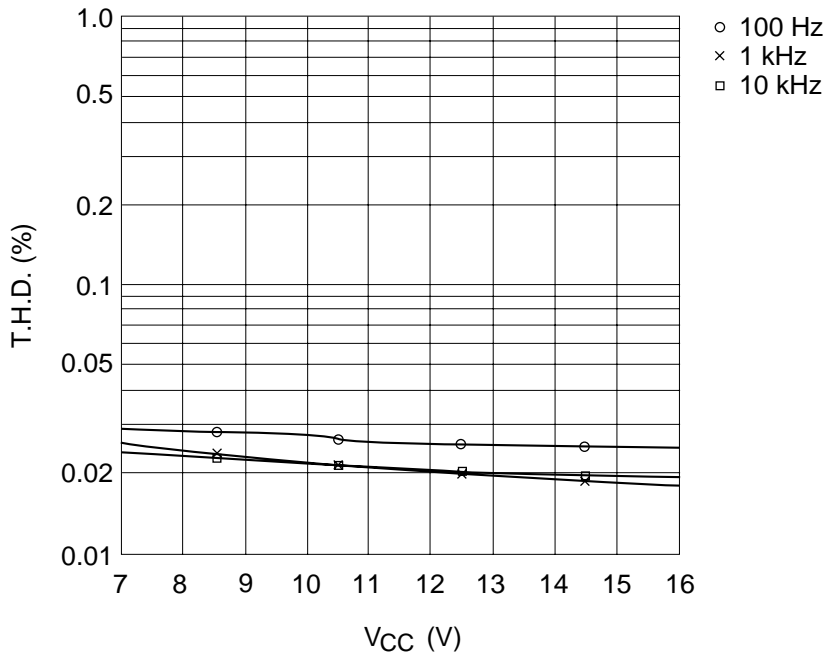

Total Harmonic Distortion vs. Supply Voltage (PB MODE NR-B)

HA12141NT, HA12142NT, HA12170NT, HA12161FP, HA12162FP

HA12141NT, HA12161FP

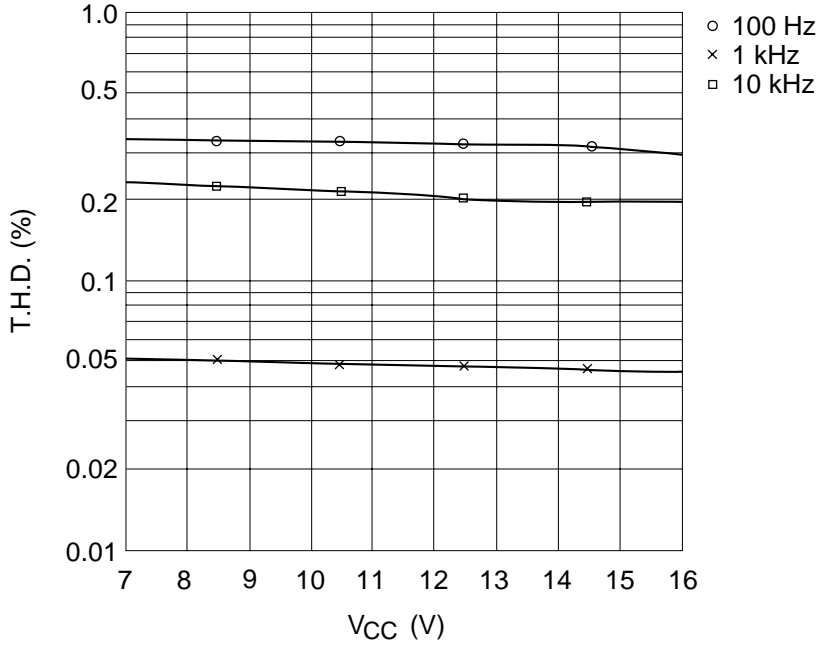

Total Harmonic Distortion vs. Supply Voltage (PB MODE NR-C)

HA12141NT

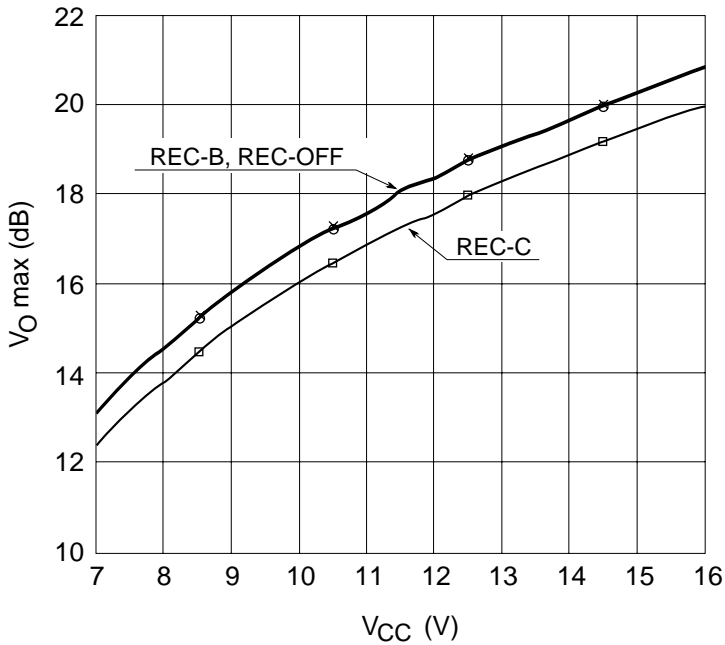

Maximum Output Level vs. Supply Voltage (REC MODE)

HA12141NT, HA12142NT, HA12170NT, HA12161FP, HA12162FP

HA12141NT, HA12161FP

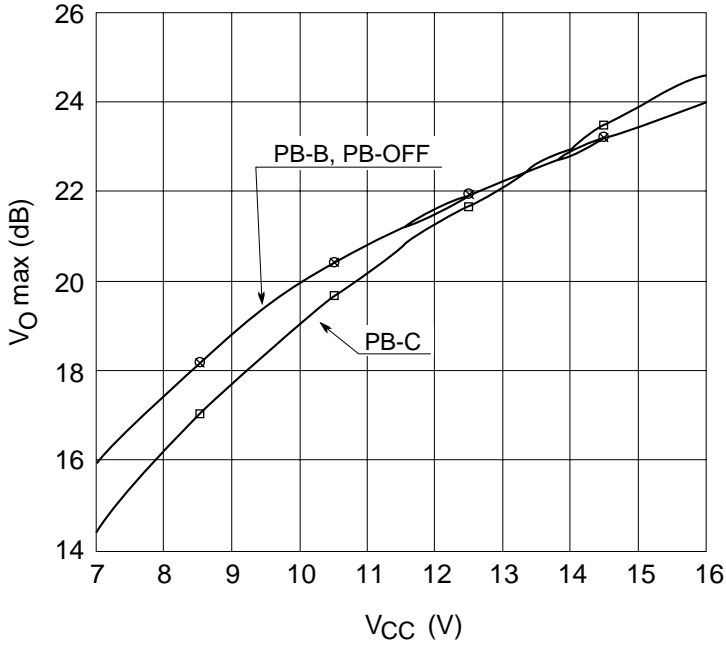

Maximum Output Level vs. Supply Voltage (PB MODE)

HA12141NT, HA12161FP

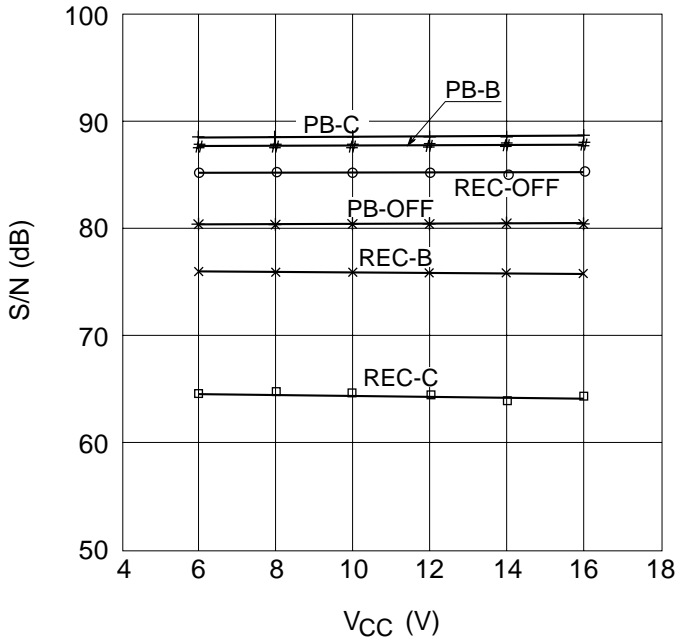

S/N vs. Supply Voltage

HA12141NT, HA12142NT, HA12170NT, HA12161FP, HA12162FP

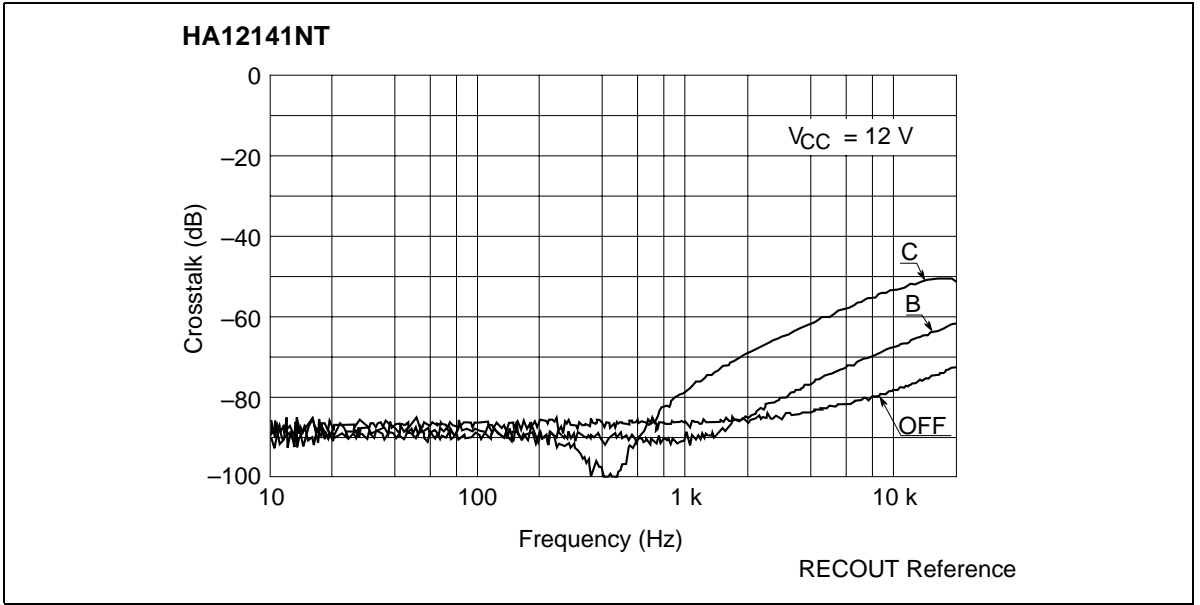

Crosstalk vs. Frequency (REC MODE R→L)

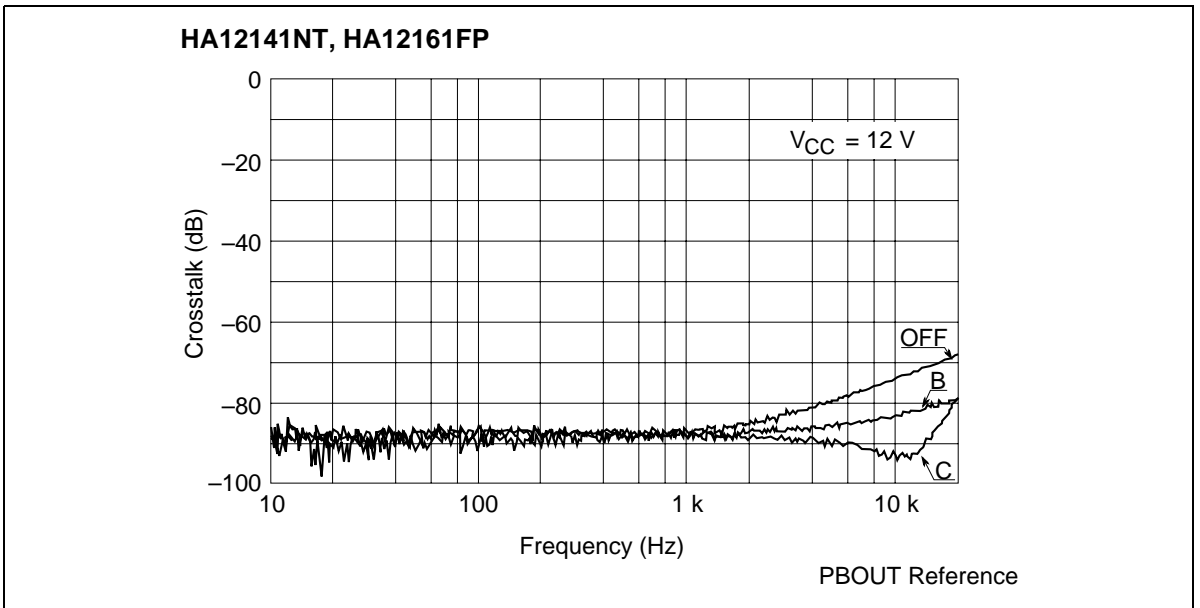

Crosstalk vs. Frequency (PB MODE R→L)

HA12141NT, HA12142NT, HA12170NT, HA12161FP, HA12162FP

HA12141NT, HA12161FP

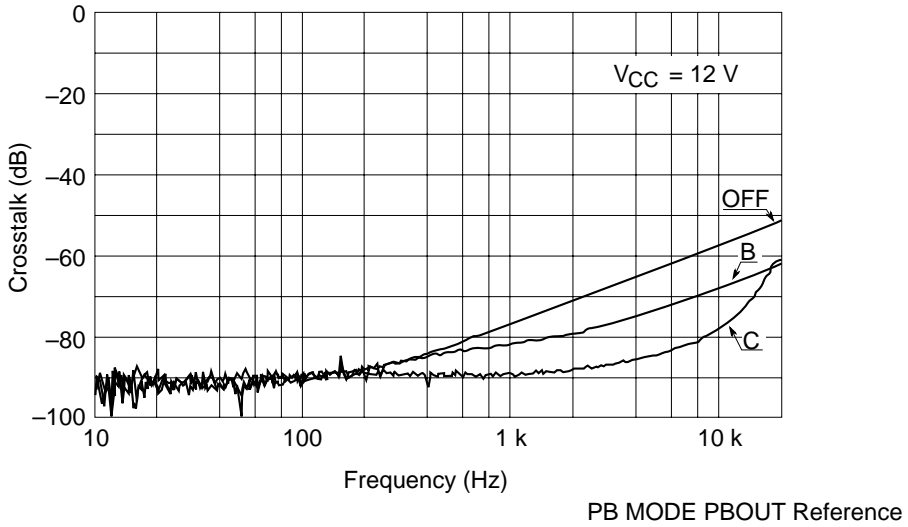

Crosstalk vs. Frequency (REC→PB)

HA12141NT

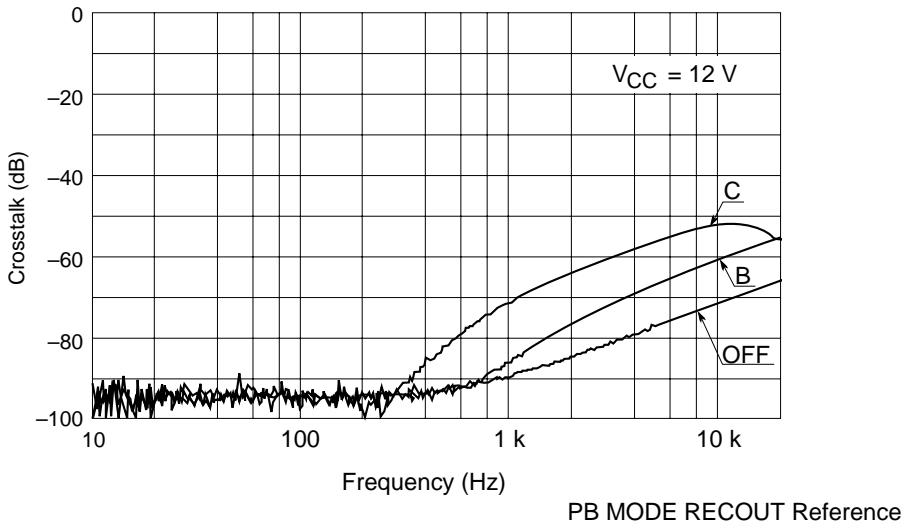

Crosstalk vs. Frequency (PB→REC)

HA12141NT, HA12142NT, HA12170NT, HA12161FP, HA12162FP

HA12141NT

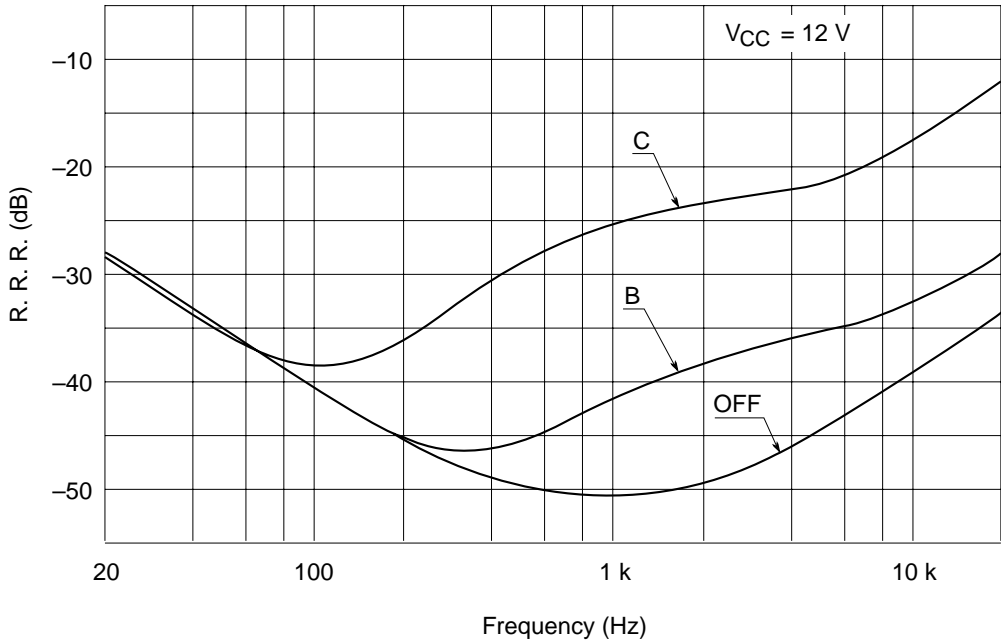

Ripple Rejection Ratio vs. Frequency (REC MODE RECOUT)

HA12141NT, HA12161FP

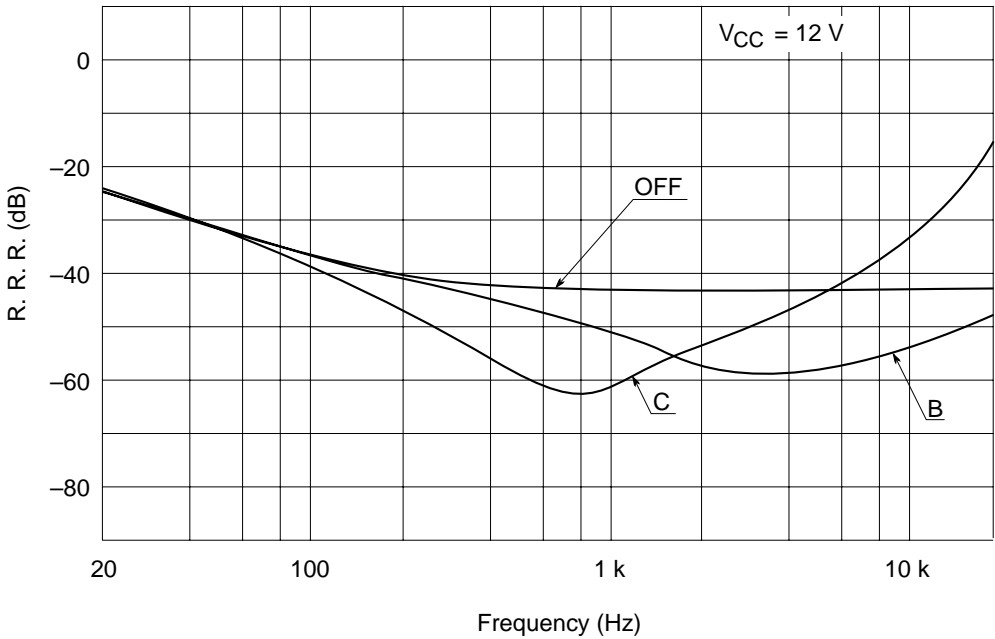

Ripple Rejection Ratio vs. Frequency (PB MODE PBOU)

HA12141NT, HA12142NT, HA12170NT, HA12161FP, HA12162FP

HA12142NT

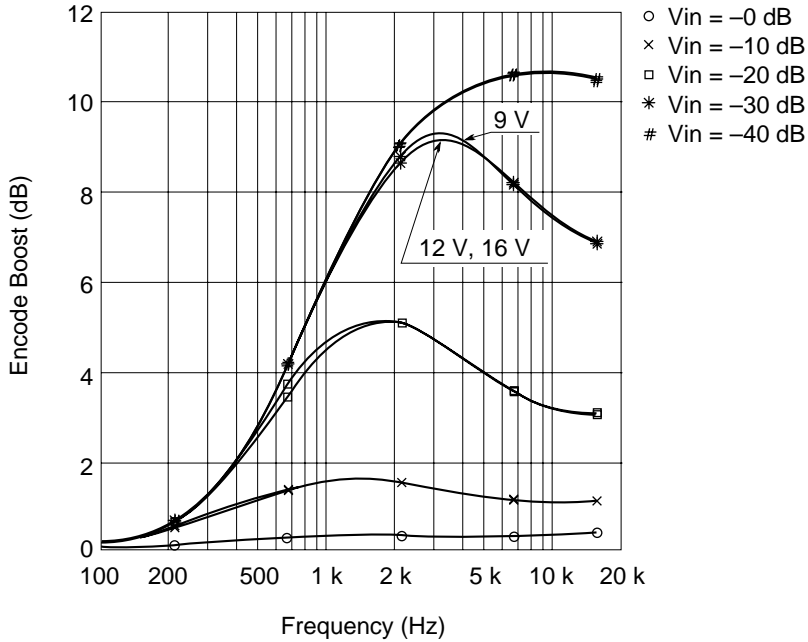

Encode Boost vs. Frequency (NR-B, $V_{cc} = 9$ V, 12 V, 16 V)

HA12142NT

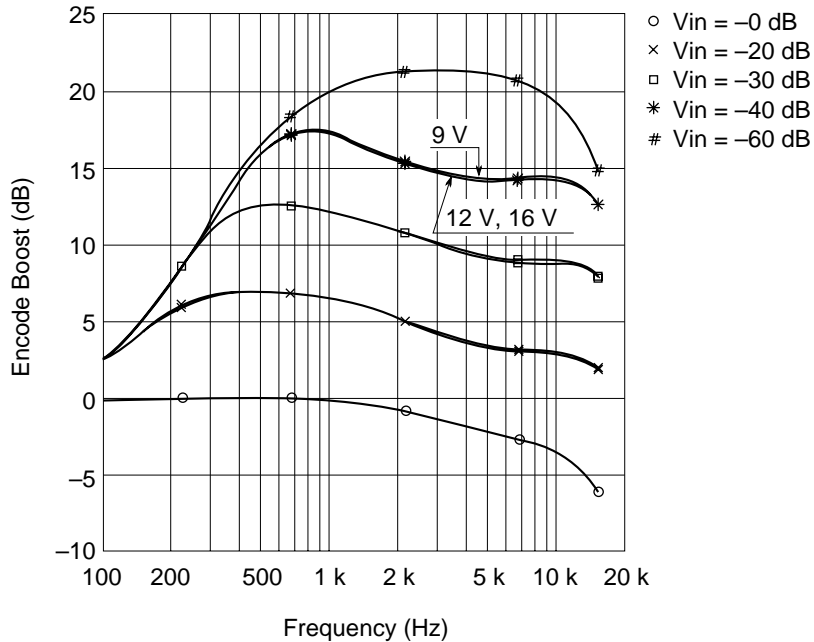

Encode Boost vs. Frequency (NR-C, $V_{cc} = 9$ V, 12 V, 16 V)

HA12141NT, HA12142NT, HA12170NT, HA12161FP, HA12162FP

HA12142NT, HA12162FP

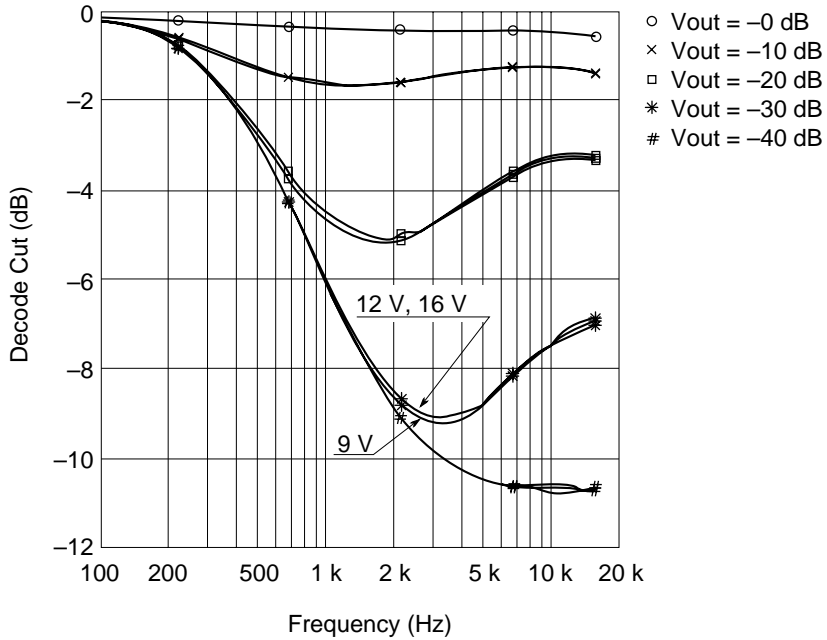

Decode Cut vs. Frequency (NR-B, $V_{cc} = 9V, 12V, 16V$)

HA12142NT, HA12162FP

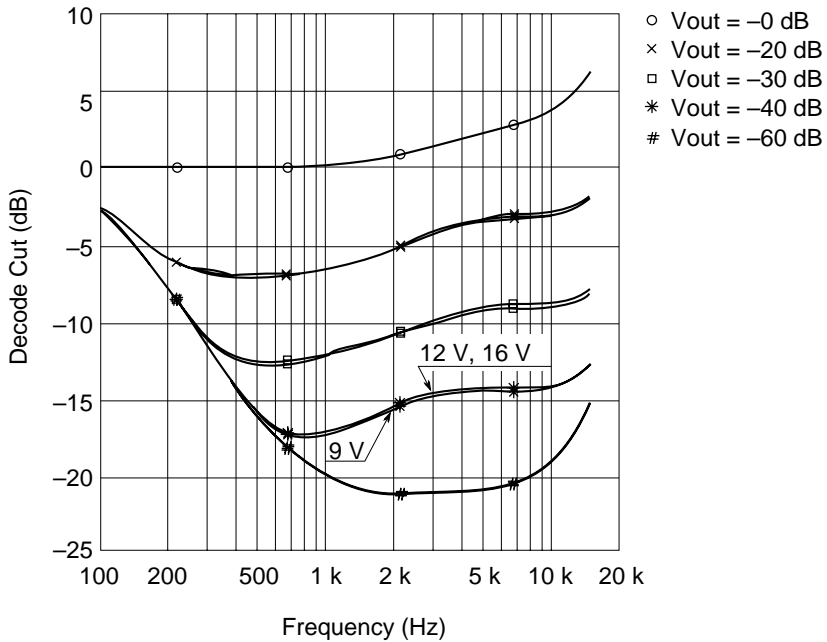

Decode Cut vs. Frequency (NR-C, $V_{cc} = 9V, 12V, 16V$)

HA12141NT, HA12142NT, HA12170NT, HA12161FP, HA12162FP

HA12142NT

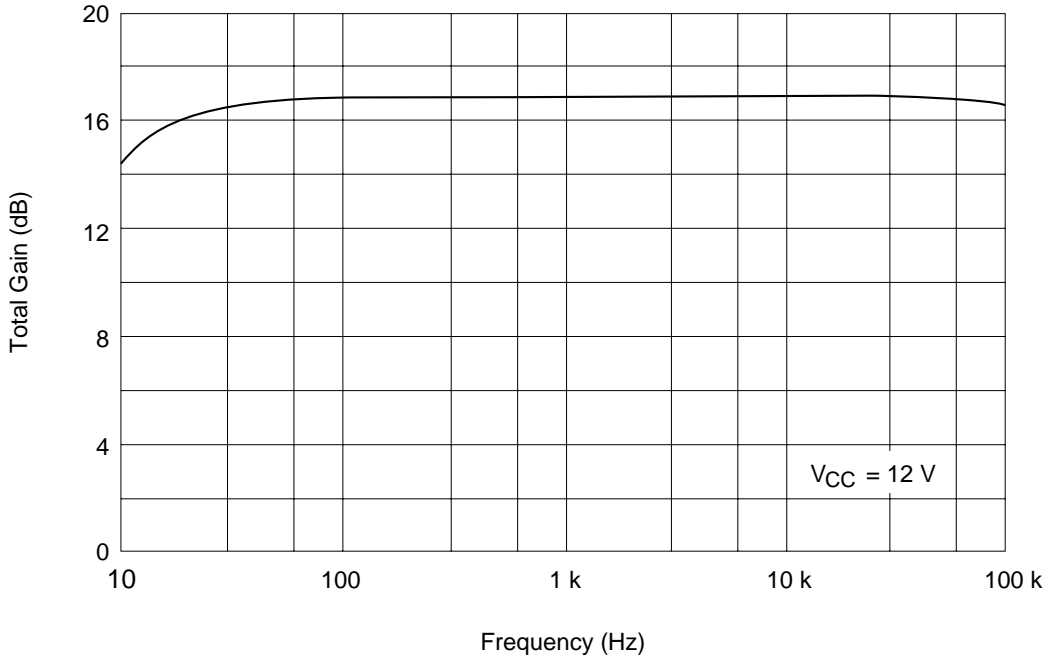

Total Gain vs. Frequency (REC MODE RECOUT NR-OFF)

HA12142NT, HA12162FP

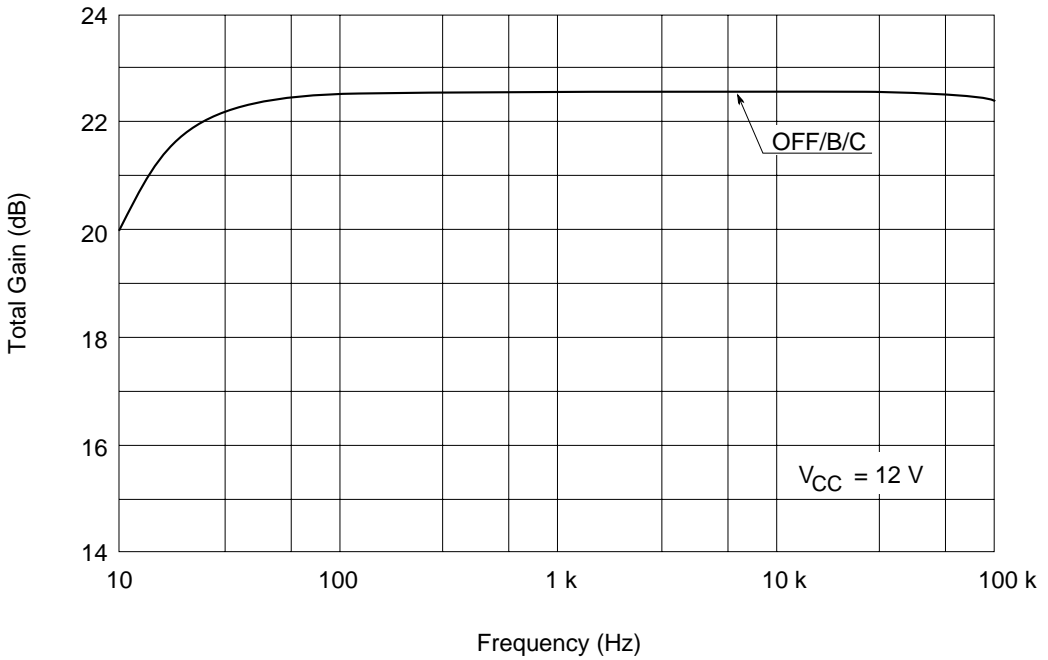

Total Gain vs. Frequency (REC MODE PBOUT)

HA12141NT, HA12142NT, HA12170NT, HA12161FP, HA12162FP

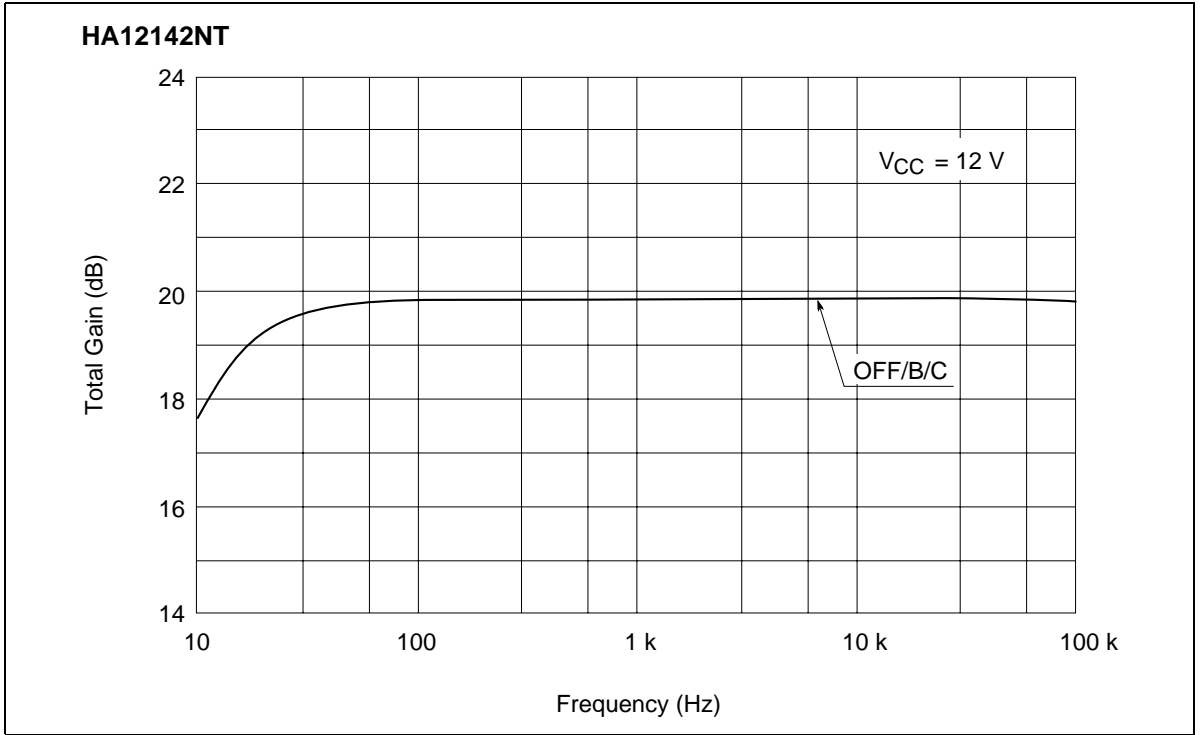

Total Gain vs. Frequency (PB MODE RECOUT)

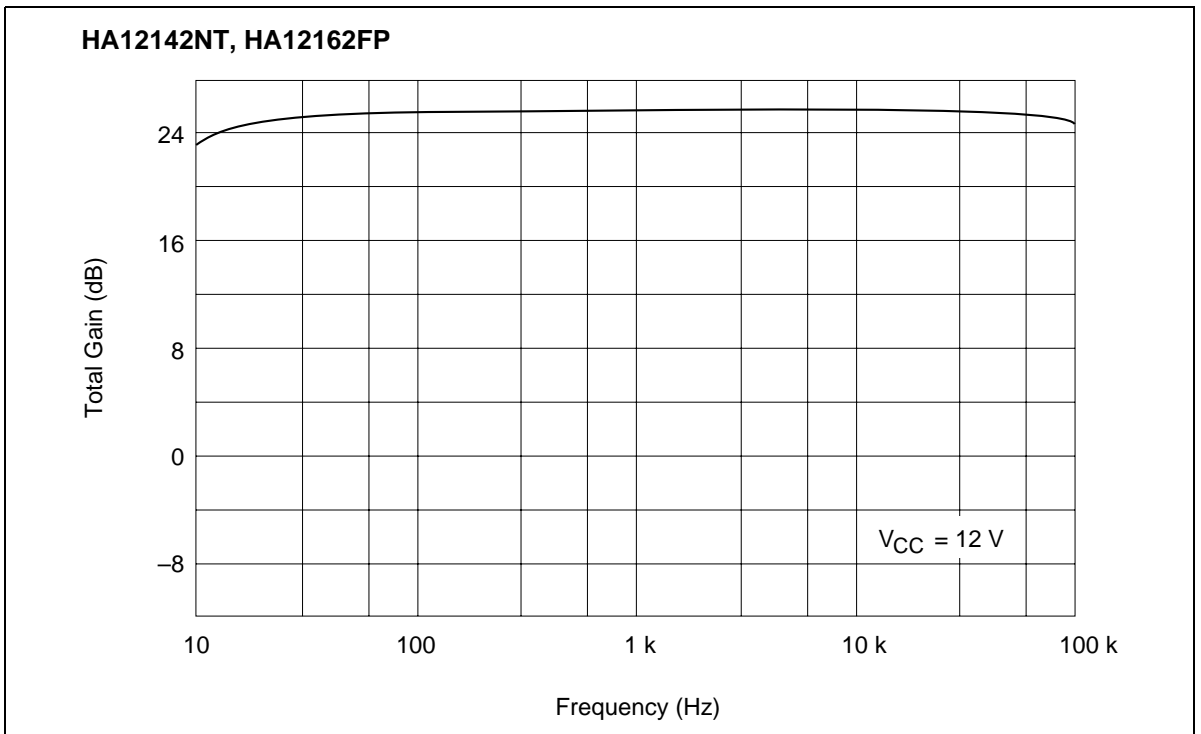

Total Gain vs. Frequency (PB MODE PBOUR NR-OFF)

HA12141NT, HA12142NT, HA12170NT, HA12161FP, HA12162FP

HA12142NT

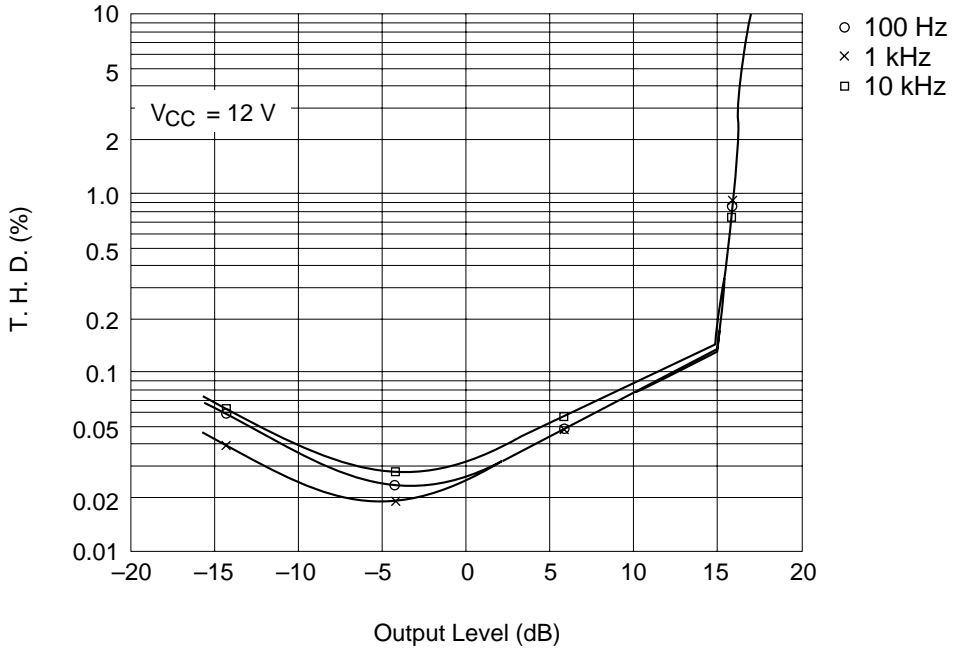

Total Harmonic Distortion vs. Output Level (REC MODE NR-OFF)

HA12142NT

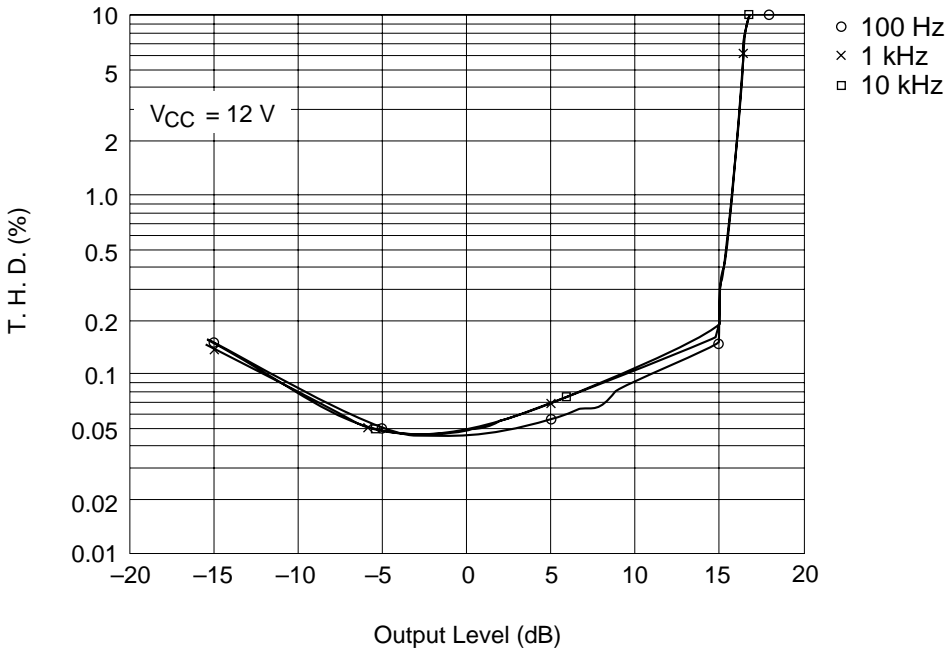

Total Harmonic Distortion vs. Output Level (REC MODE NR-B)

HA12141NT, HA12142NT, HA12170NT, HA12161FP, HA12162FP

HA12142NT

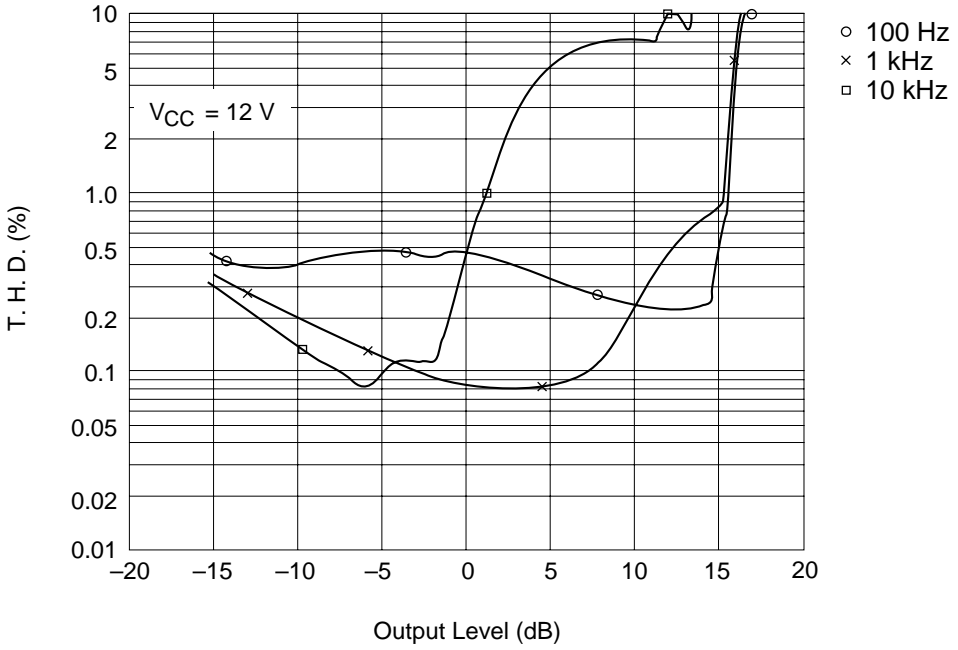

Total Harmonic Distortion vs. Output Level (REC MODE NR-C)

HA12142NT, HA12162FP

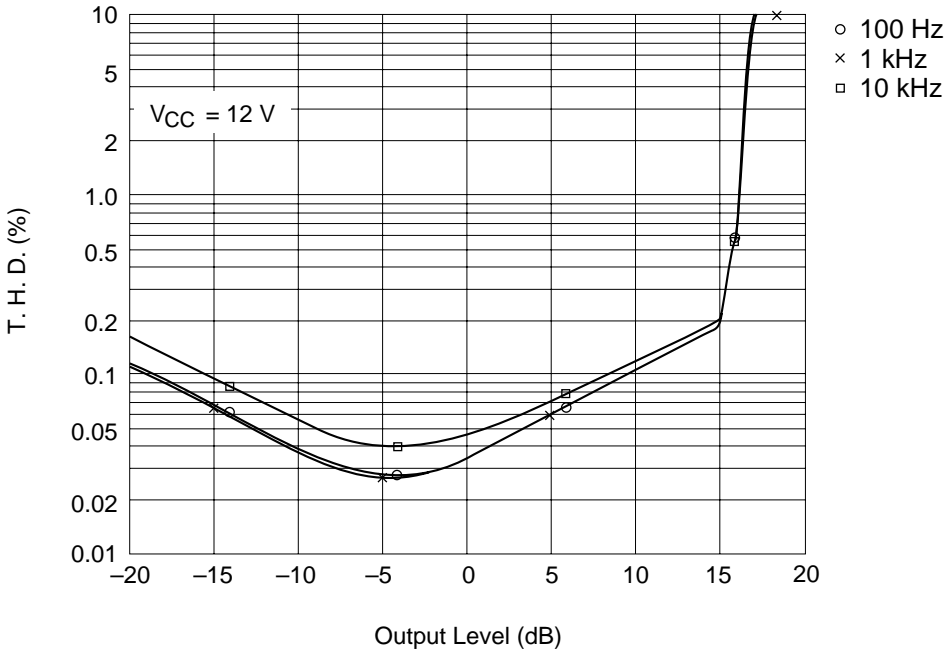

Total Harmonic Distortion vs. Output Level (PB MODE NR-OFF)

HA12141NT, HA12142NT, HA12170NT, HA12161FP, HA12162FP

HA12142NT, HA12162FP

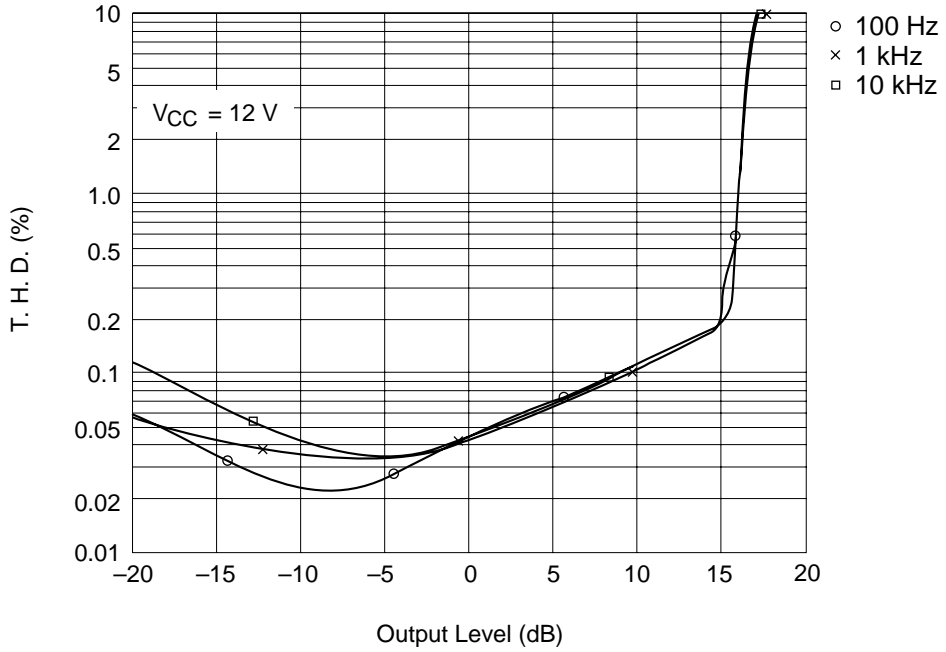

Total Harmonic Distortion vs. Output Level (PB MODE NR-B)

HA12142NT, HA12162FP

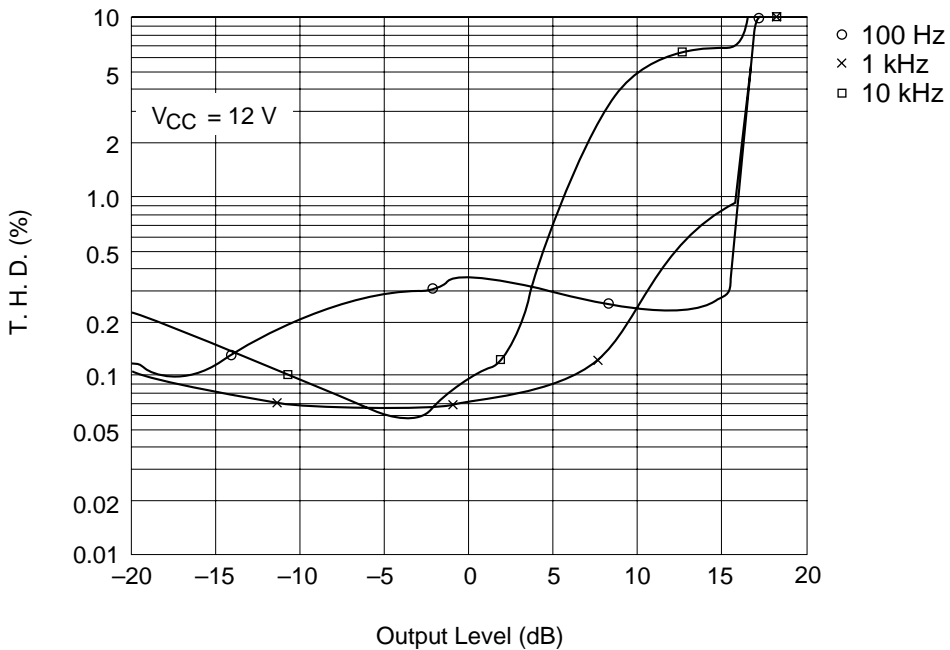

Total Harmonic Distortion vs. Output Level (PB MODE NR-C)

HA12141NT, HA12142NT, HA12170NT, HA12161FP, HA12162FP

HA12142NT

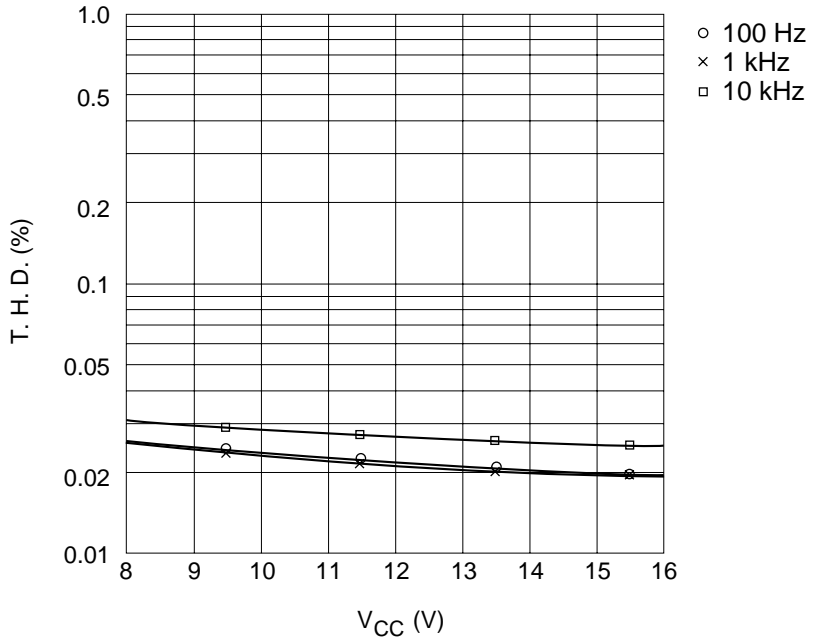

Total Harmonic Distortion vs. Supply Voltage (REC MODE NR-OFF)

HA12142NT

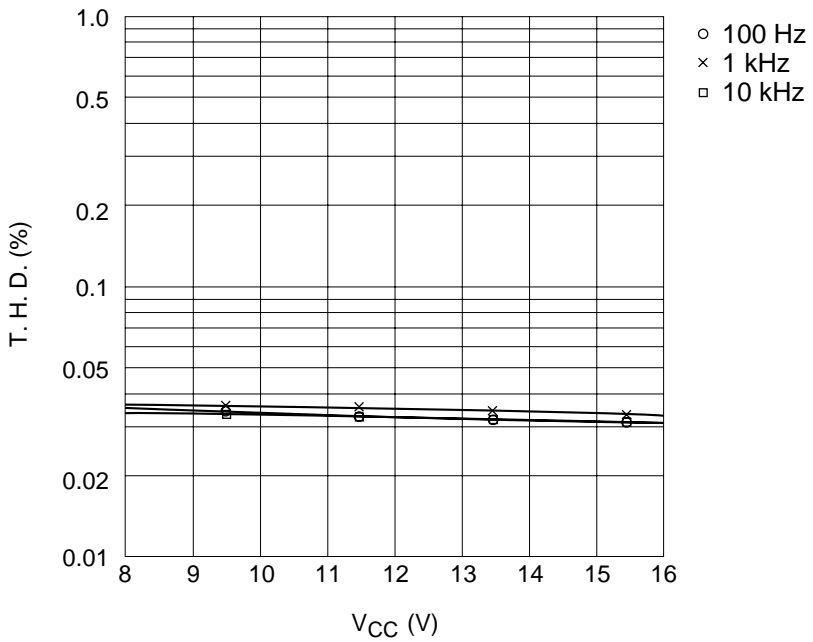

Total Harmonic Distortion vs. Supply Voltage (REC MODE NR-B)

HA12141NT, HA12142NT, HA12170NT, HA12161FP, HA12162FP

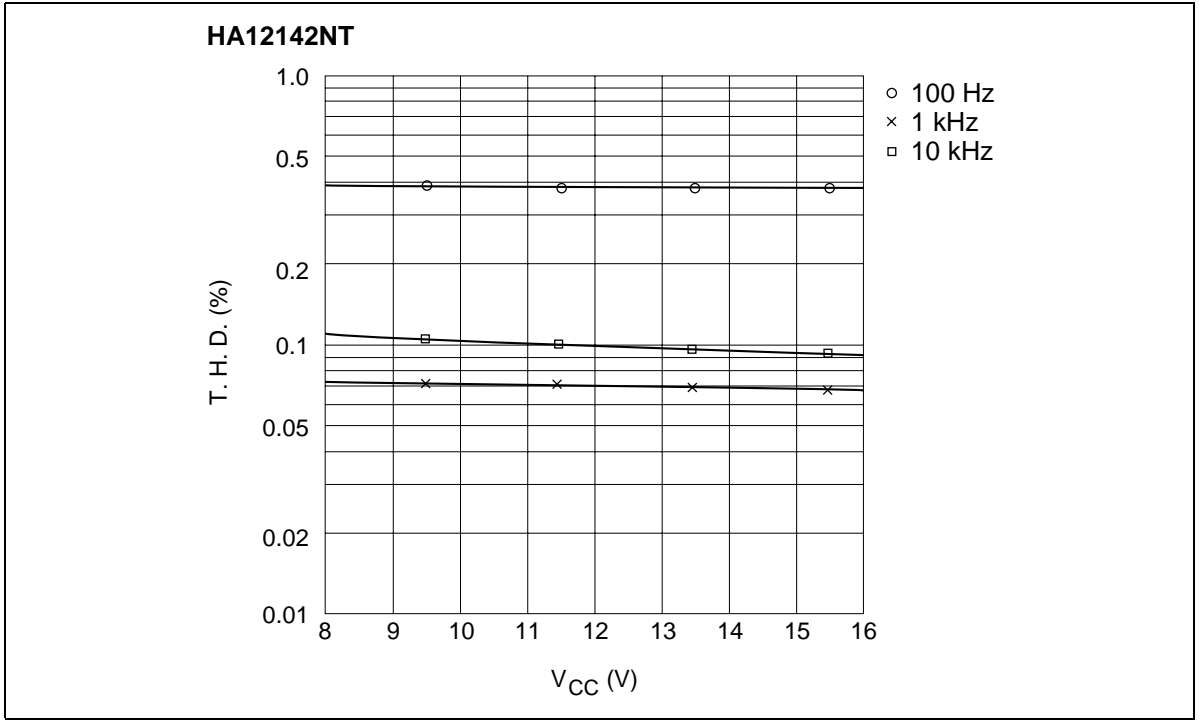

Total Harmonic Distortion vs. Supply Voltage (REC MODE NR-C)

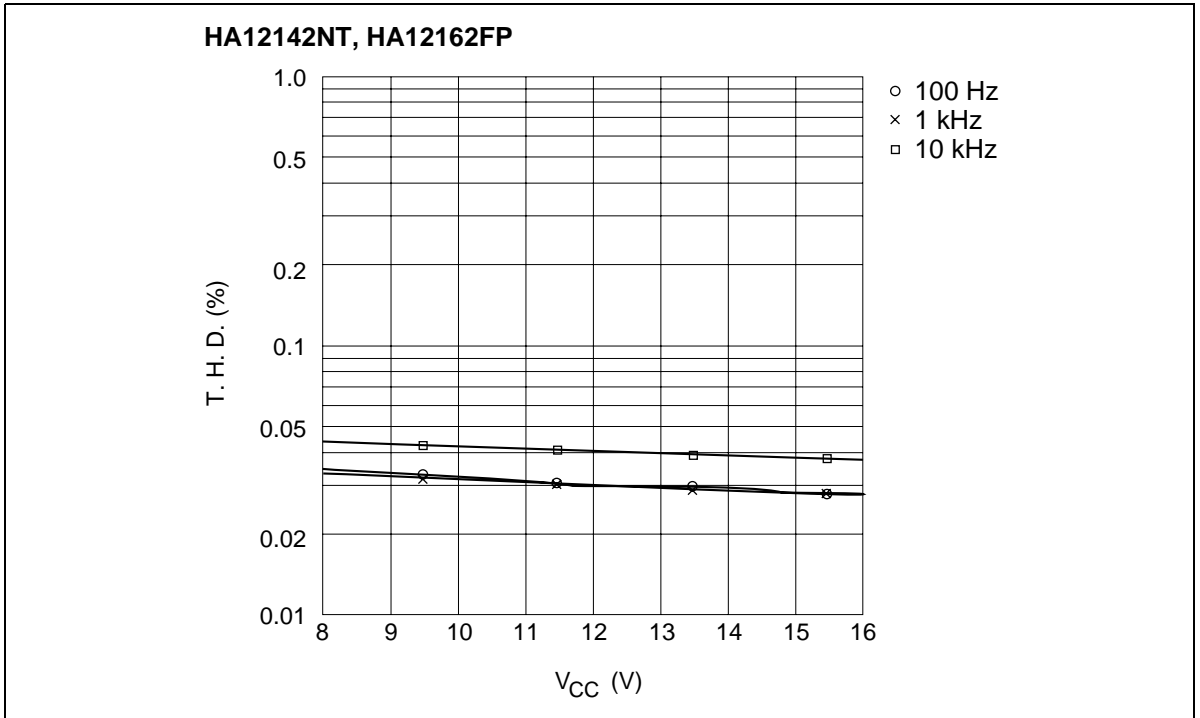

Total Harmonic Distortion vs. Supply Voltage (PB MODE NR-OFF)

HA12141NT, HA12142NT, HA12170NT, HA12161FP, HA12162FP

HA12142NT, HA12162FP

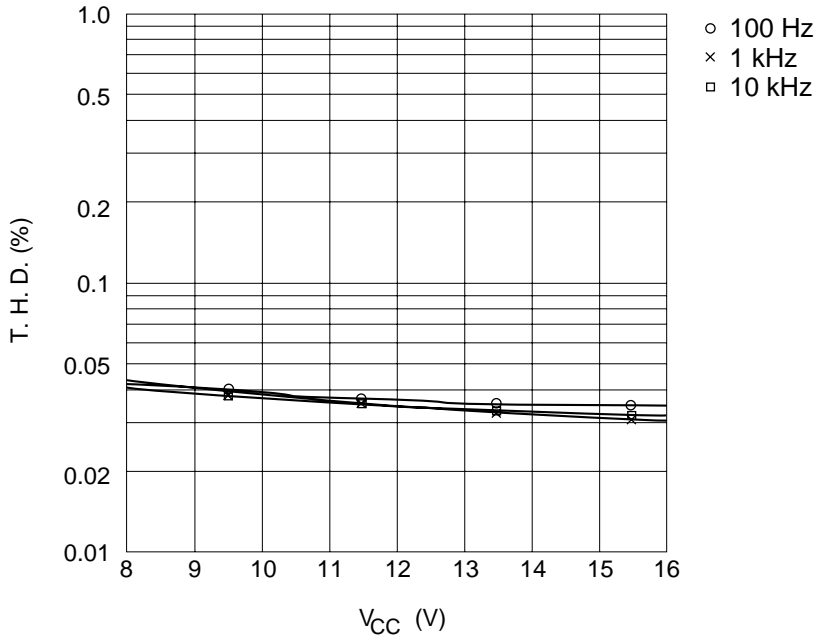

Total Harmonic Distortion vs. Supply Voltage (PB MODE NR-B)

HA12142NT, HA12162FP

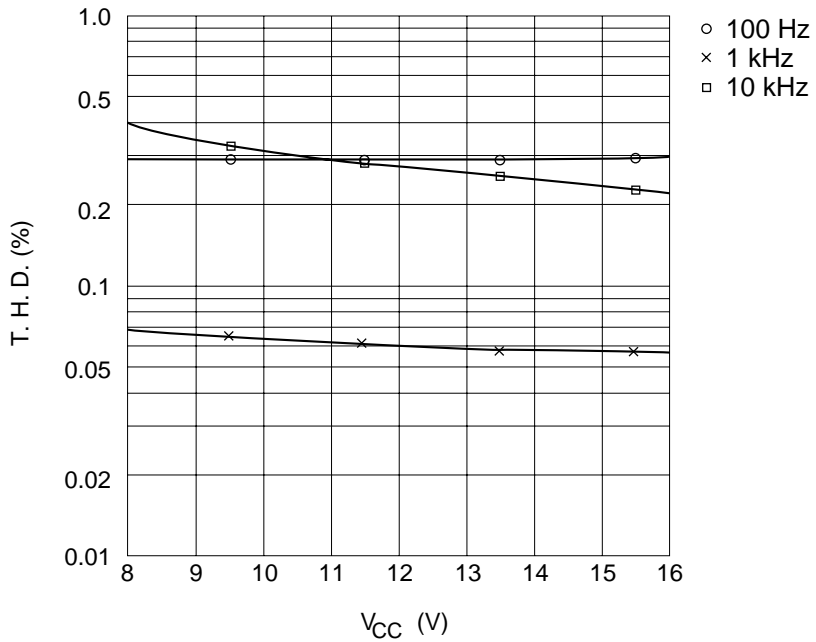

Total Harmonic Distortion vs. Supply Voltage (PB MODE NR-C)

HA12141NT, HA12142NT, HA12170NT, HA12161FP, HA12162FP

HA12142NT

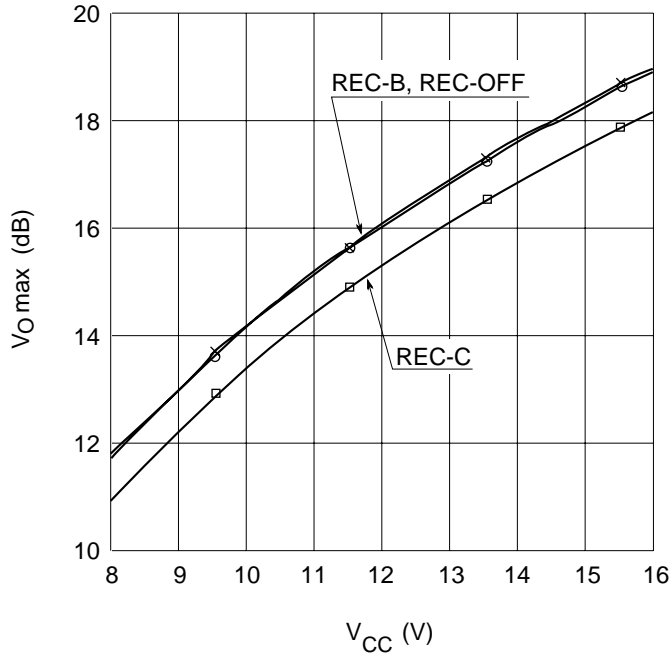

Maximum Output Level vs. Supply Voltage (REC MODE)

HA12142NT, HA12162FP

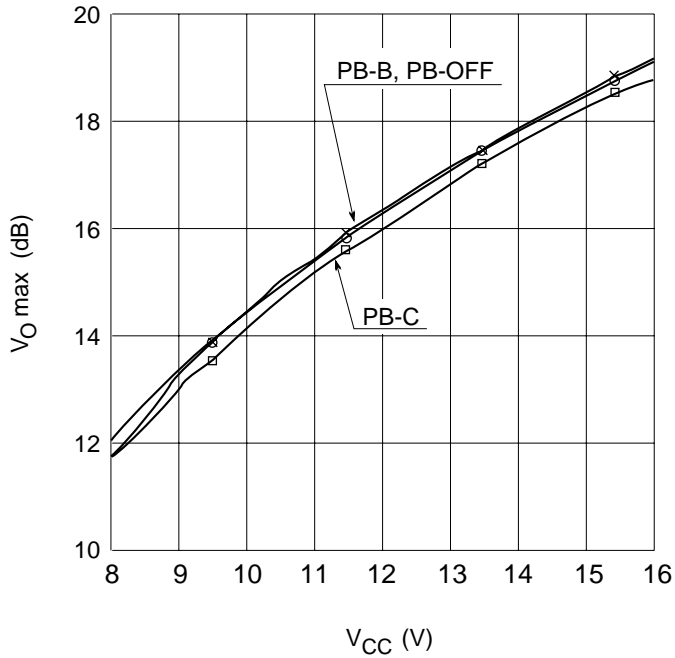

Maximum Output Level vs. Supply Voltage (PB MODE)

HA12141NT, HA12142NT, HA12170NT, HA12161FP, HA12162FP

HA12142NT, HA12162FP

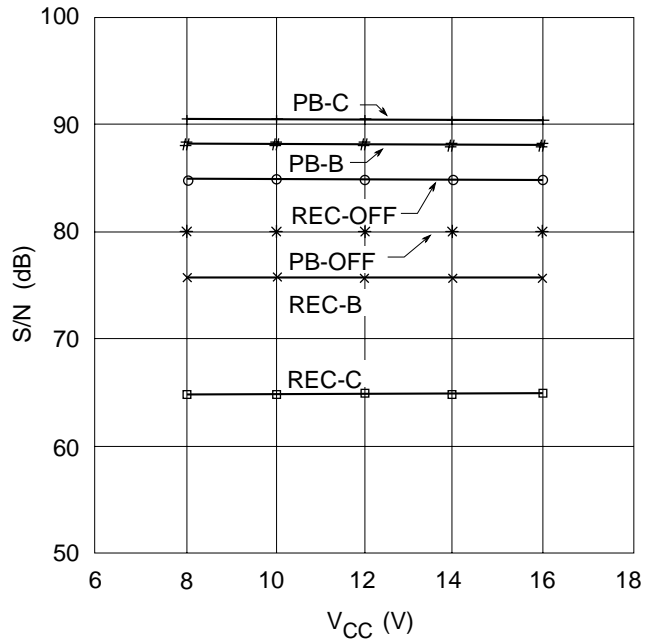

S/N vs. Supply Voltage

HA12142NT

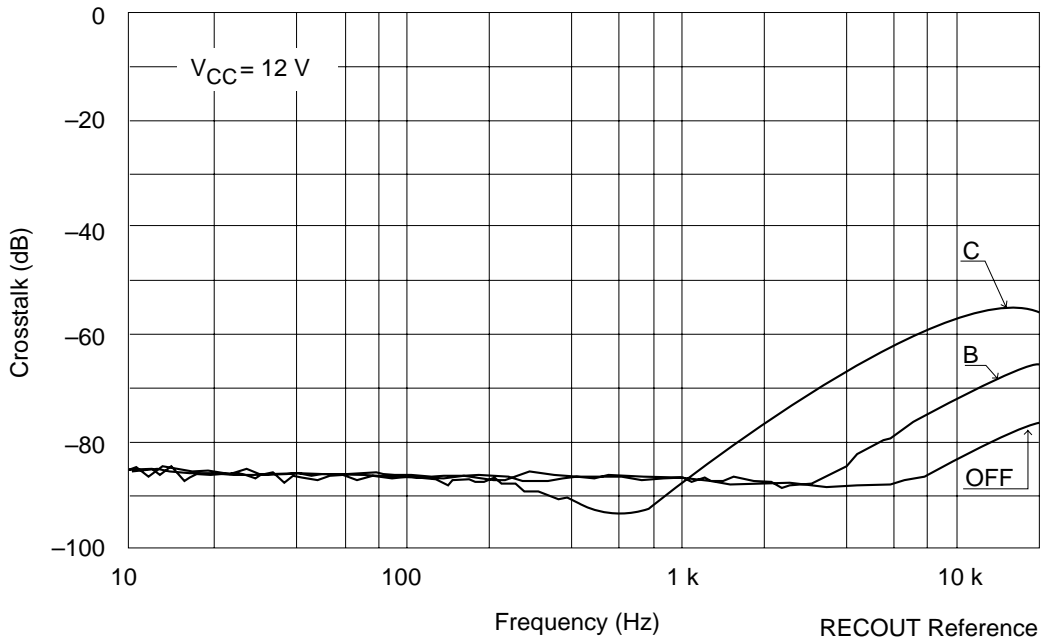

Crosstalk vs. Frequency (REC MODE R↔L)

HA12141NT, HA12142NT, HA12170NT, HA12161FP, HA12162FP

HA12142NT, HA12162FP

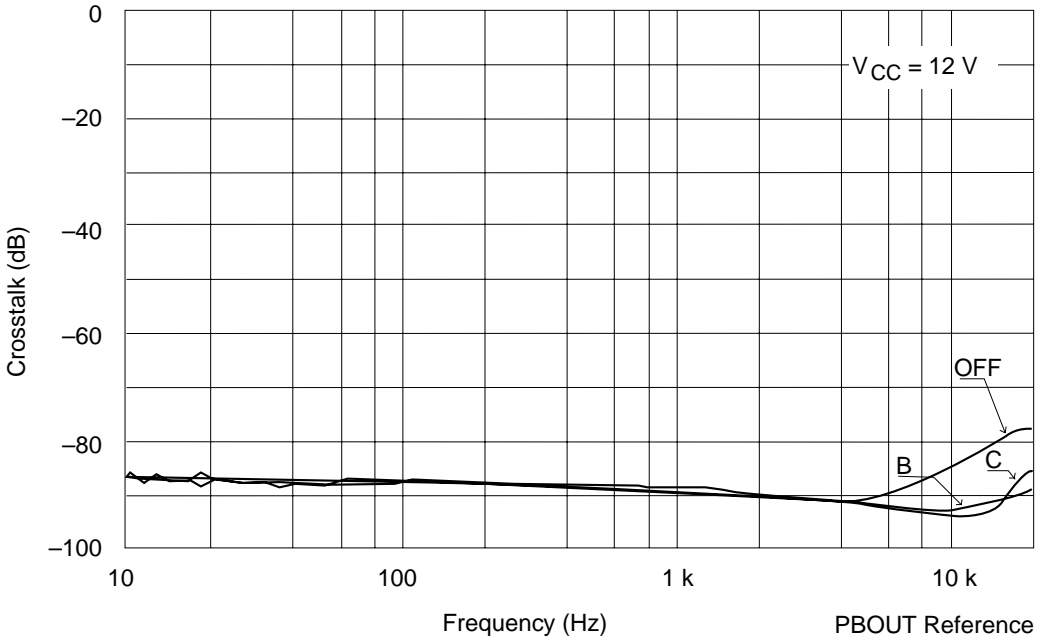

Crosstalk vs. Frequency (PB MODE R↔L)

HA12142NT

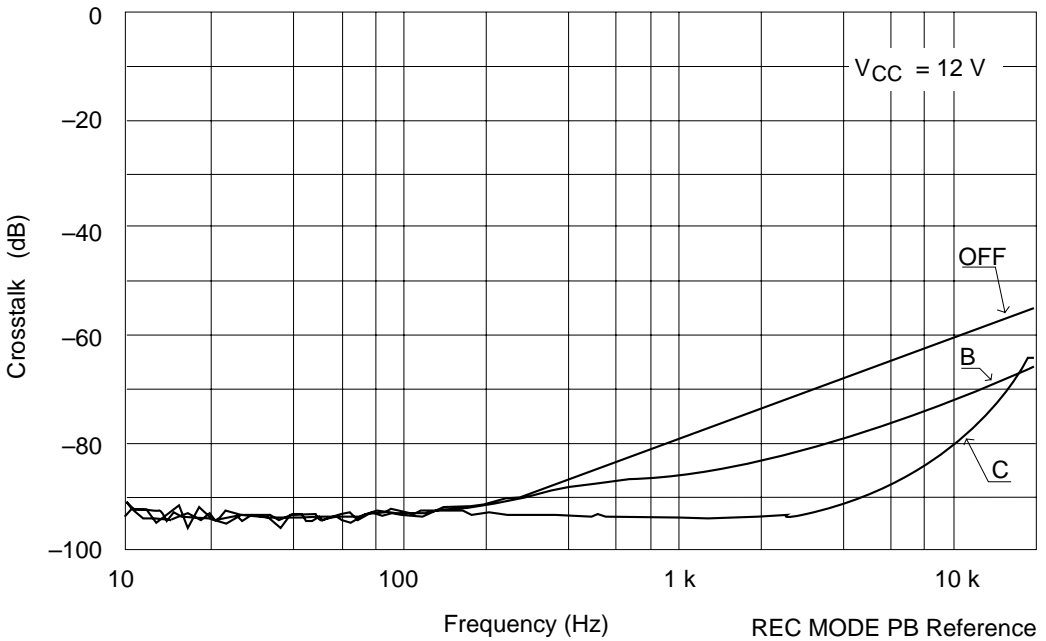

Crosstalk vs. Frequency (REC→PB)

HA12141NT, HA12142NT, HA12170NT, HA12161FP, HA12162FP

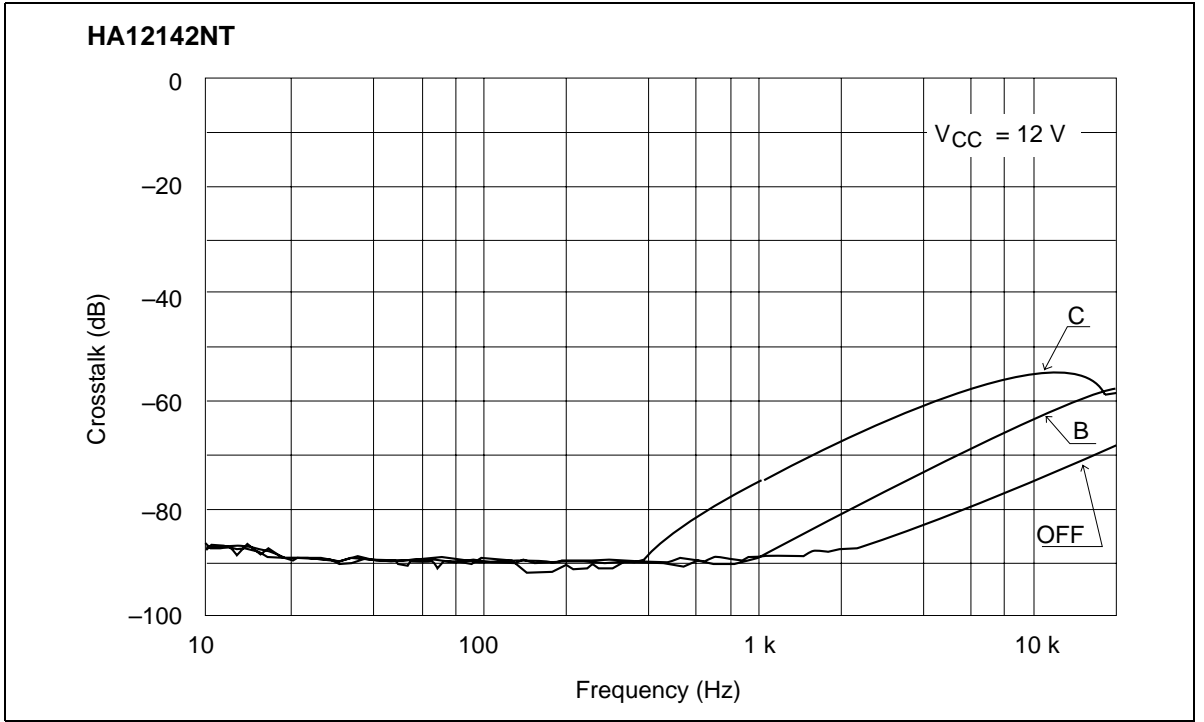

Crosstalk vs. Frequency (PB→REC)

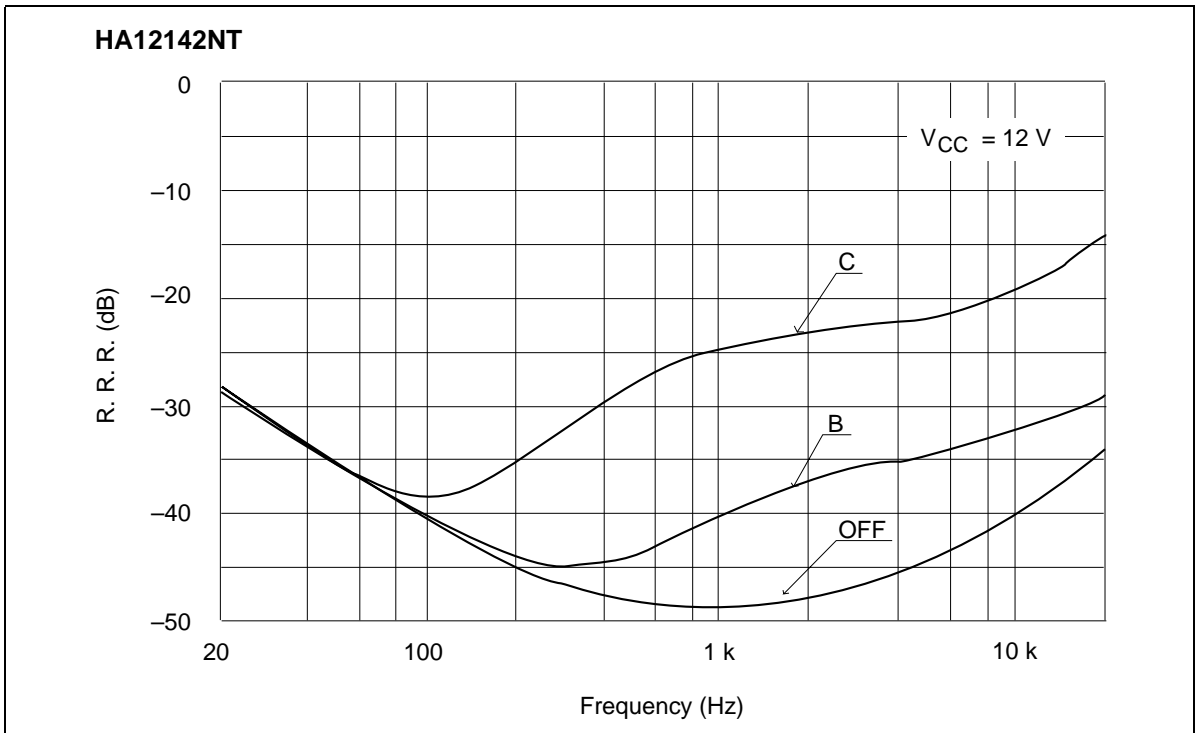

Ripple Rejection Ratio vs. Frequency (REC MODE RECOUT)

HA12141NT, HA12142NT, HA12170NT, HA12161FP, HA12162FP

HA12142NT, HA12162FP

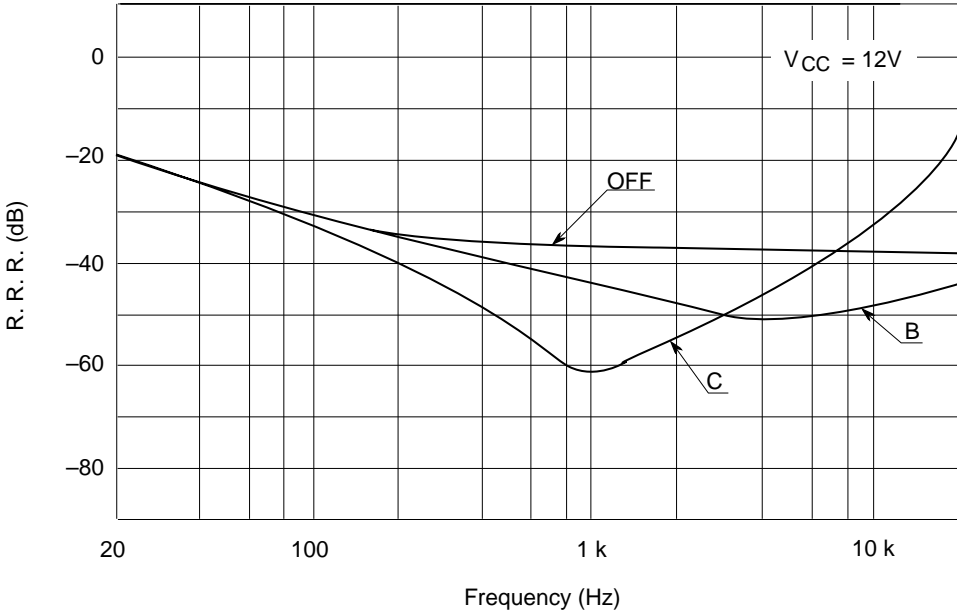

Ripple Rejection Ratio vs. Frequency (PB MODE RECOUT)

HA12170NT

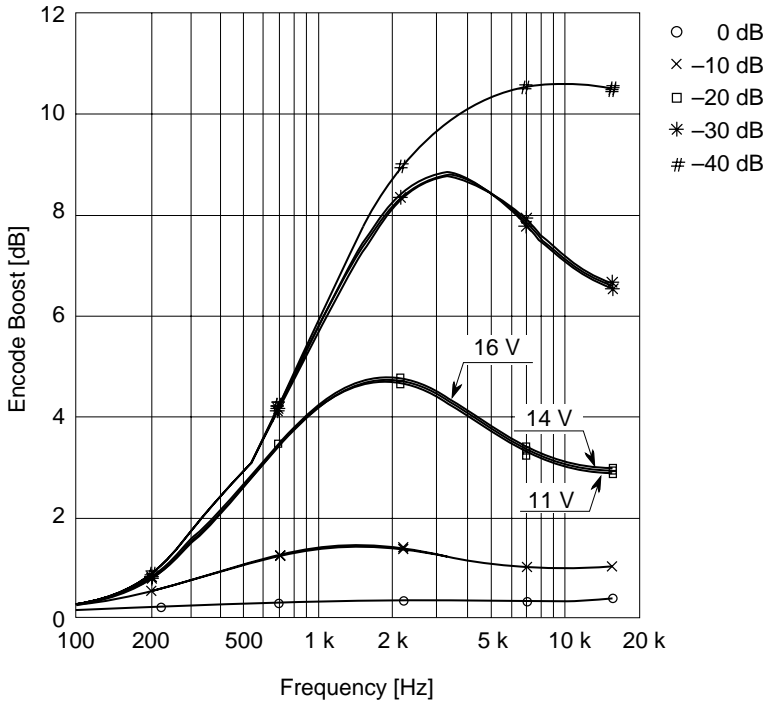

Encode Boost vs. Frequency (NR-B $V_{CC} = 11 V, 14 V, 16 V$)

HA12141NT, HA12142NT, HA12170NT, HA12161FP, HA12162FP

HA12170NT

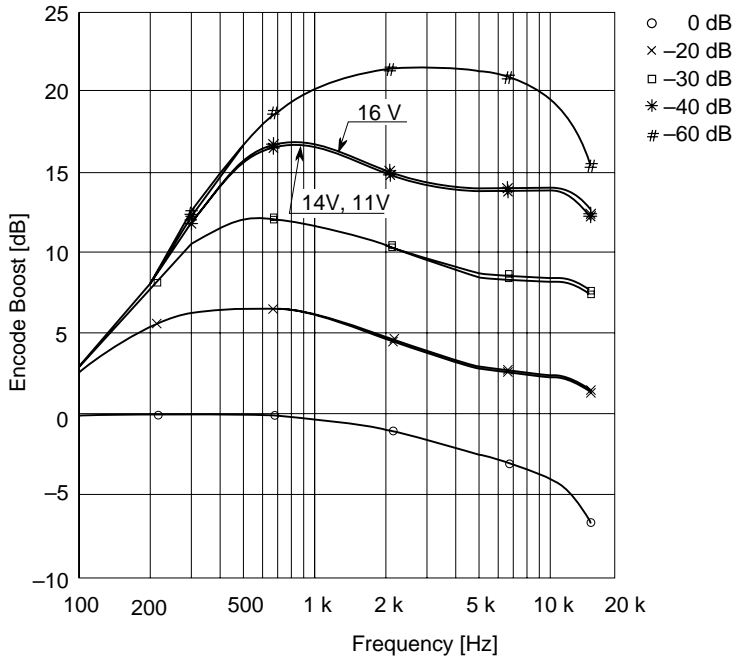

Encode Boost vs. Frequency (NR-C $V_{CC} = 11\text{ V}, 14\text{ V}, 16\text{ V}$)

HA12170NT

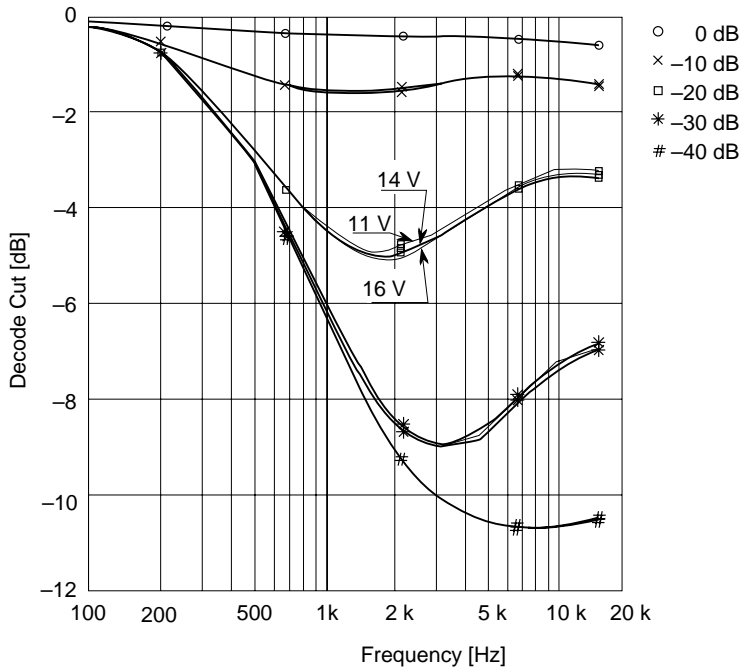

Decode Cut vs. Frequency (NR-B $V_{CC} = 11\text{ V}, 14\text{ V}, 16\text{ V}$)

HA12141NT, HA12142NT, HA12170NT, HA12161FP, HA12162FP

HA12170NT

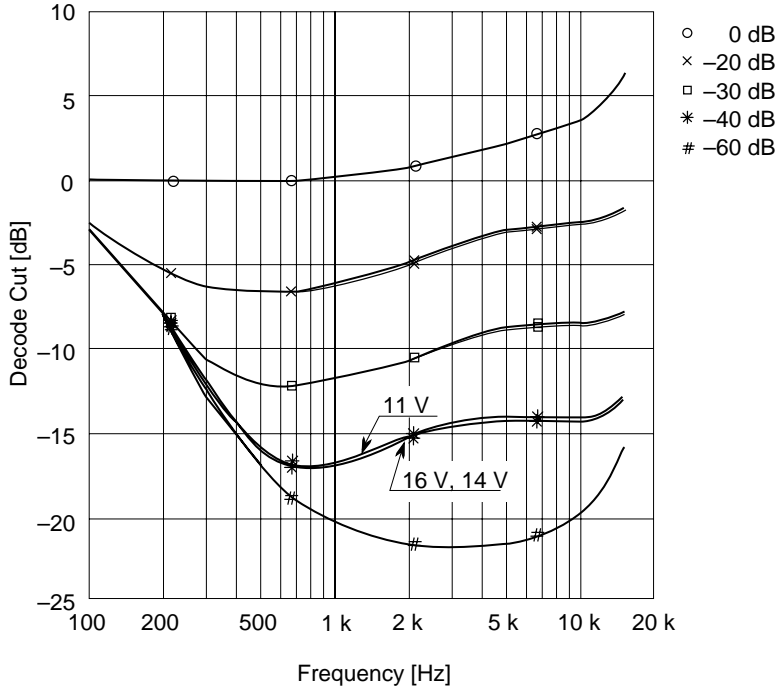

Decode Cut vs. Frequency (NR-C V_{cc} = 11 V, 14 V, 16 V)

HA12170NT

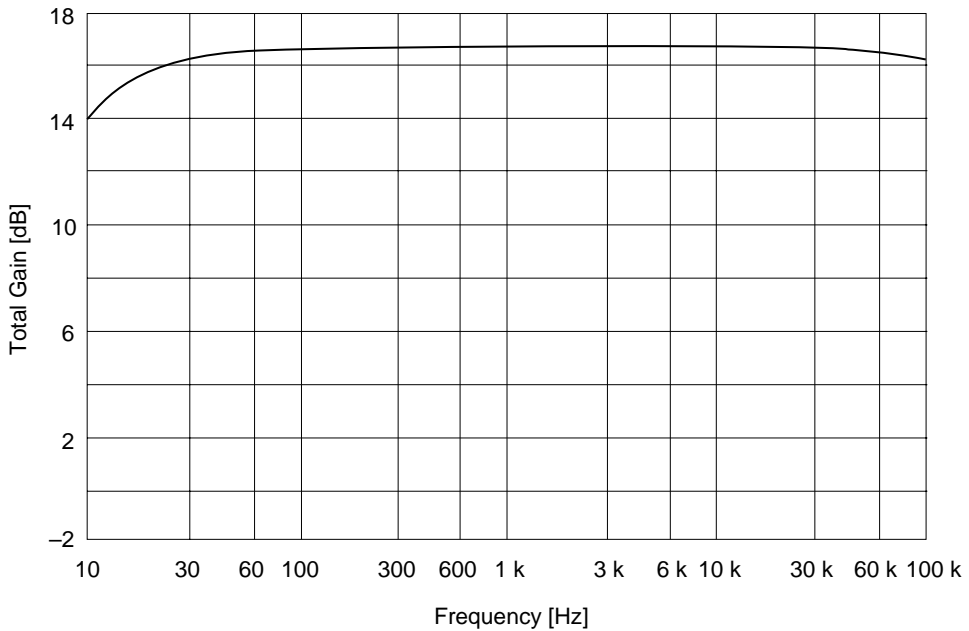

Total Gain vs. Frequency (REC MODE RECOUT NR-OFF V_{cc} = 14 V)

HA12141NT, HA12142NT, HA12170NT, HA12161FP, HA12162FP

HA12170NT

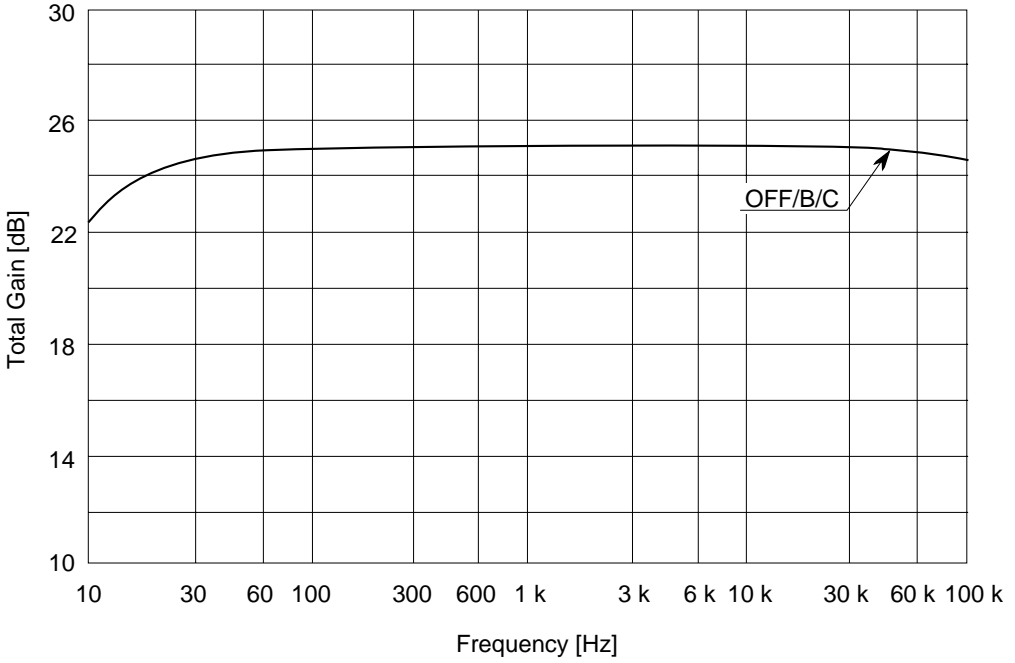

Total Gain vs. Frequency (REC MODE PBOUT $V_{cc} = 14 V$)

HA12170NT

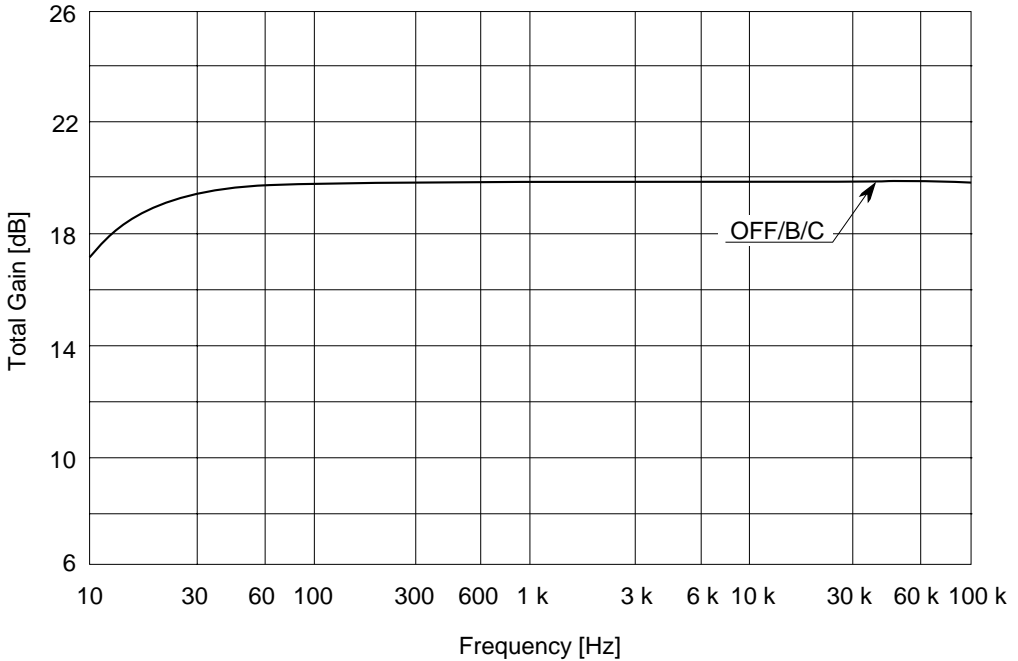

Total Gain vs. Frequency (PB MODE RECOUT $V_{cc} = 14 V$)

HA12141NT, HA12142NT, HA12170NT, HA12161FP, HA12162FP

HA12170NT

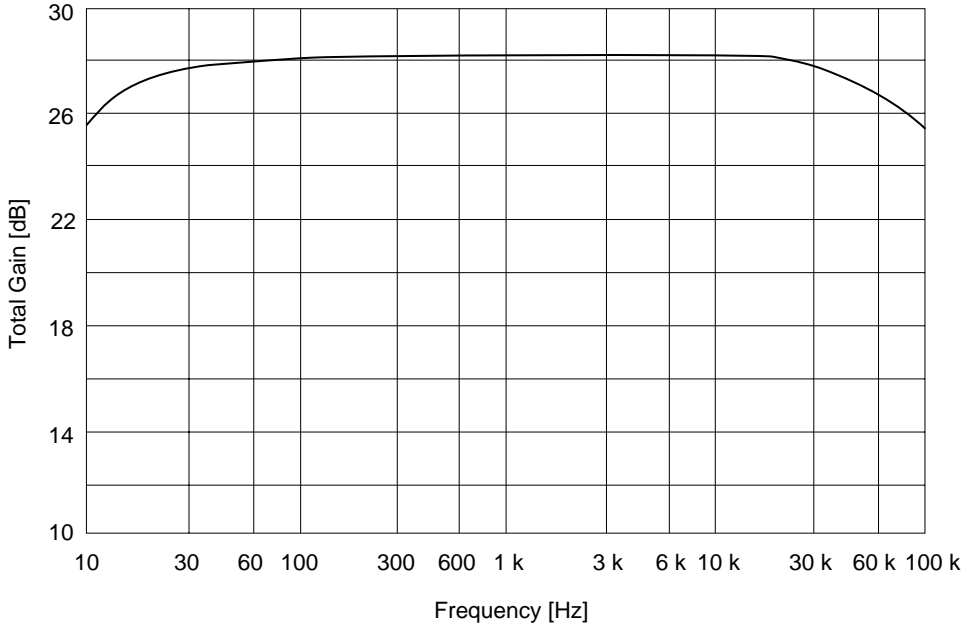

Total Gain vs. Frequency (PB MODE PBOUt NR-OFF $V_{cc} = 14\text{ V}$)

HA12170NT

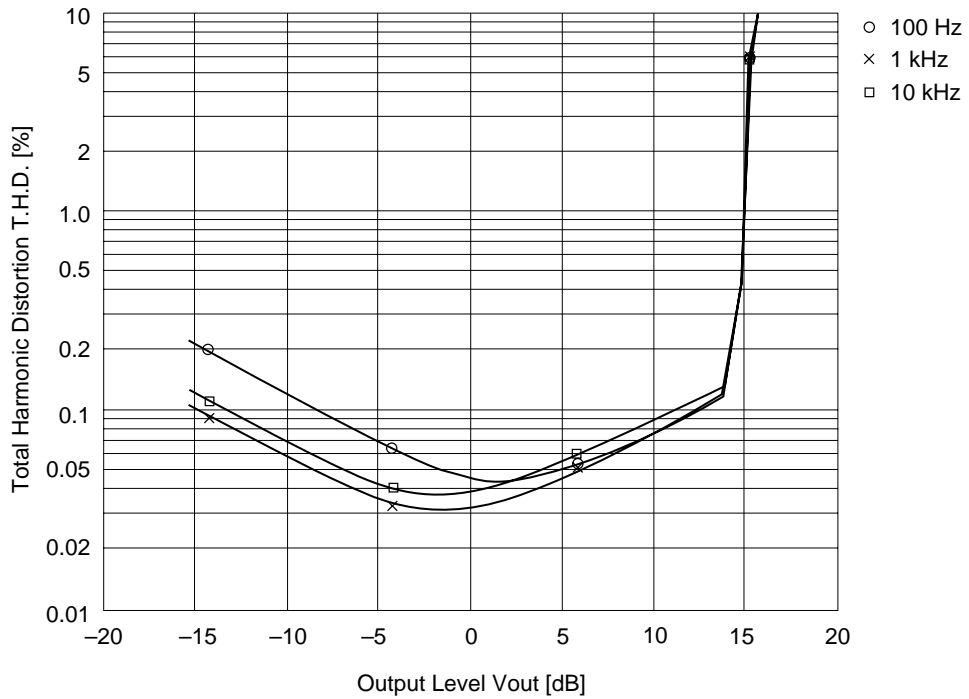

Total Harmonic Distortion vs. Output Level (REC MODE NR-OFF $V_{cc} = 14\text{ V}$)

HA12141NT, HA12142NT, HA12170NT, HA12161FP, HA12162FP

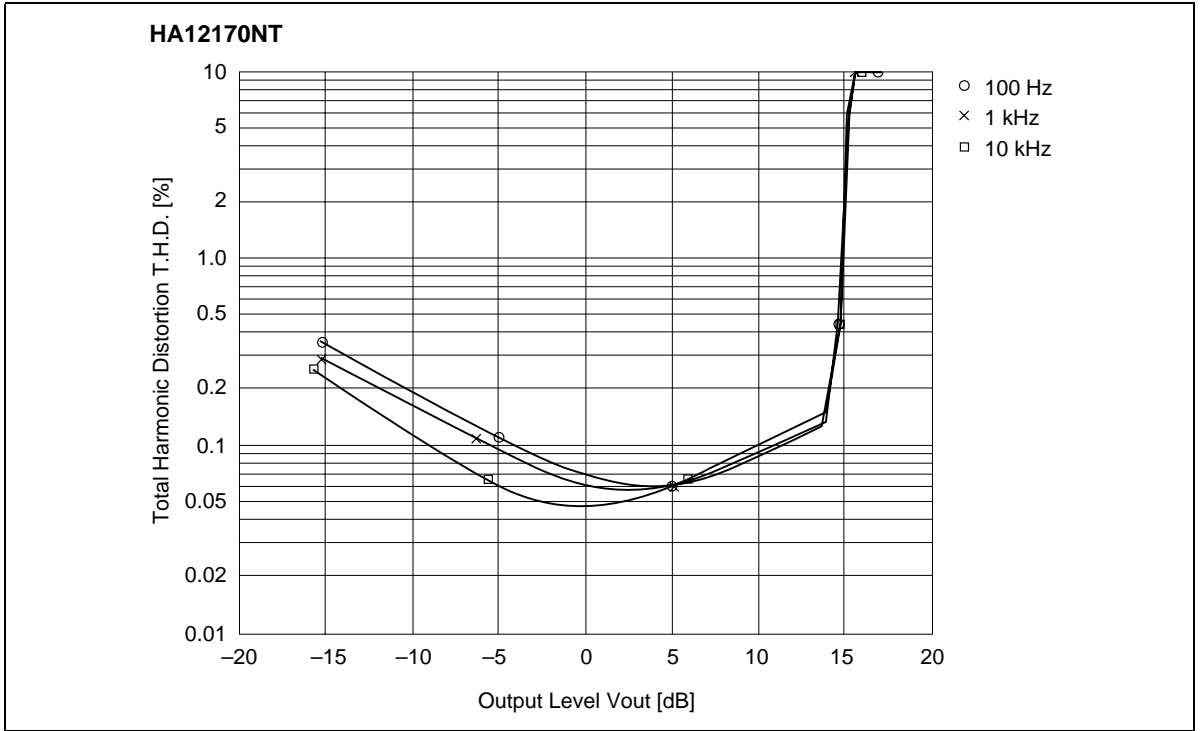

Total Harmonic Distortion vs. Output Level (REC MODE NR-B $V_{CC} = 14\text{ V}$)

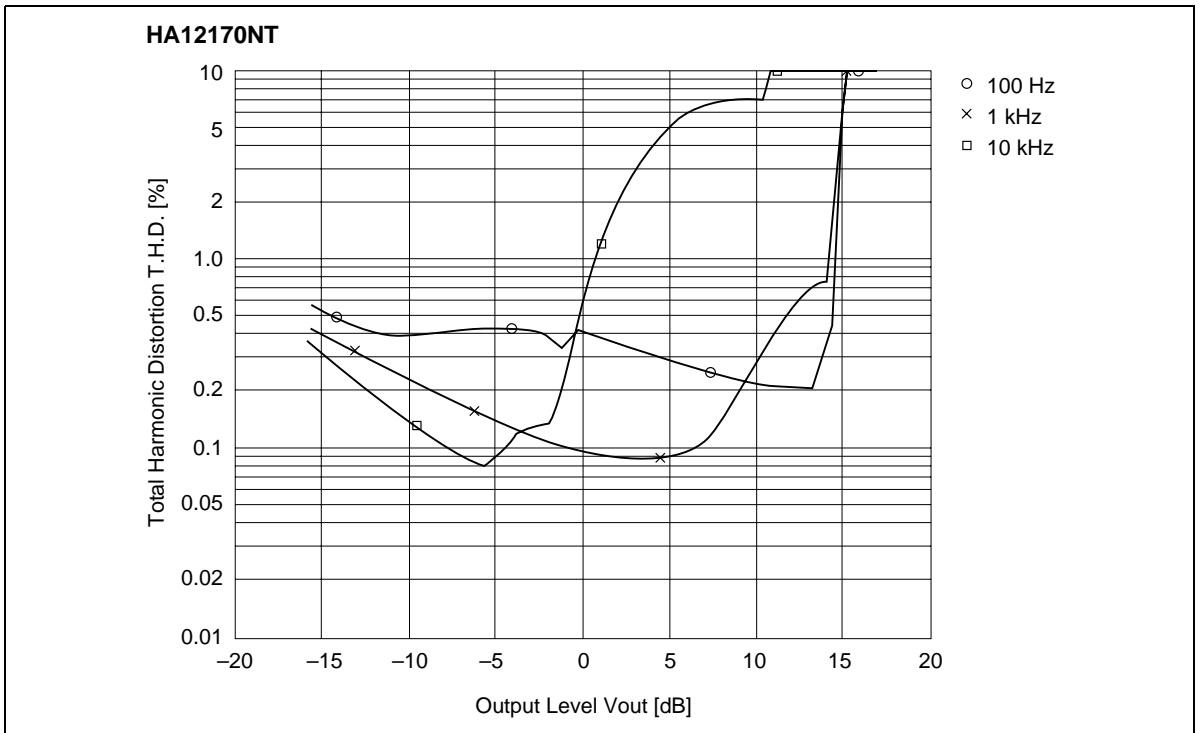

Total Harmonic Distortion vs. Output Level (REC MODE NR-C $V_{CC} = 14\text{ V}$)

HA12141NT, HA12142NT, HA12170NT, HA12161FP, HA12162FP

HA12170NT

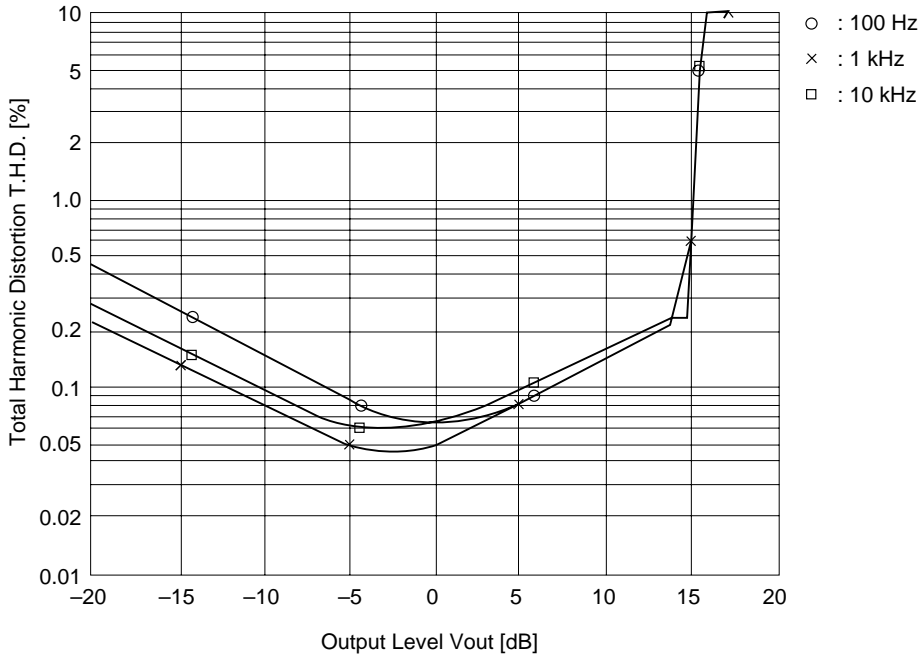

Total Harmonic Distortion vs. Output Level (PB MODE NR-OFF $V_{cc} = 14\text{ V}$)

HA12170NT

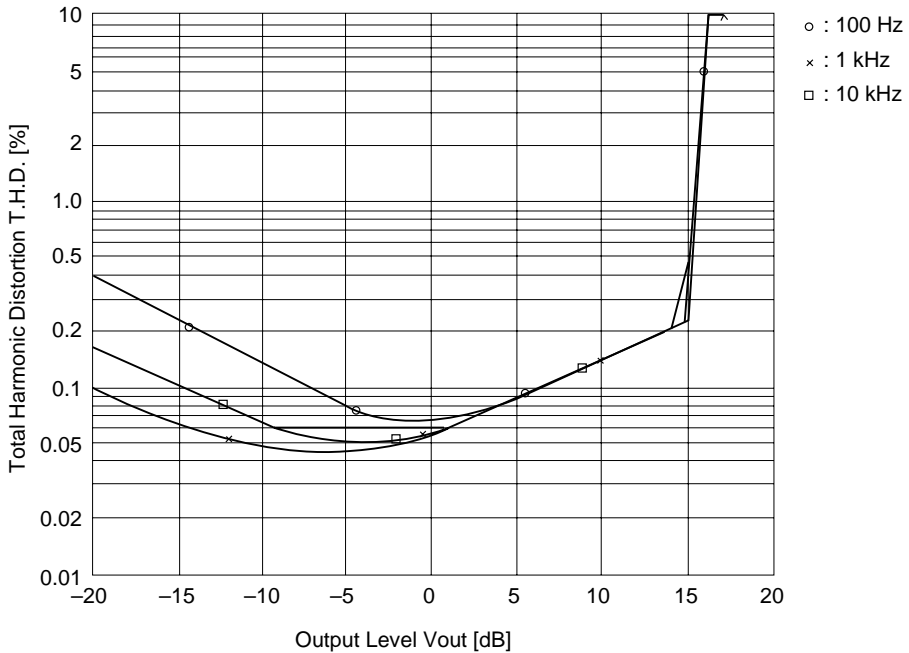

Total Harmonic Distortion vs. Output Level (PB MODE NR-B $V_{cc} = 14\text{ V}$)

HA12141NT, HA12142NT, HA12170NT, HA12161FP, HA12162FP

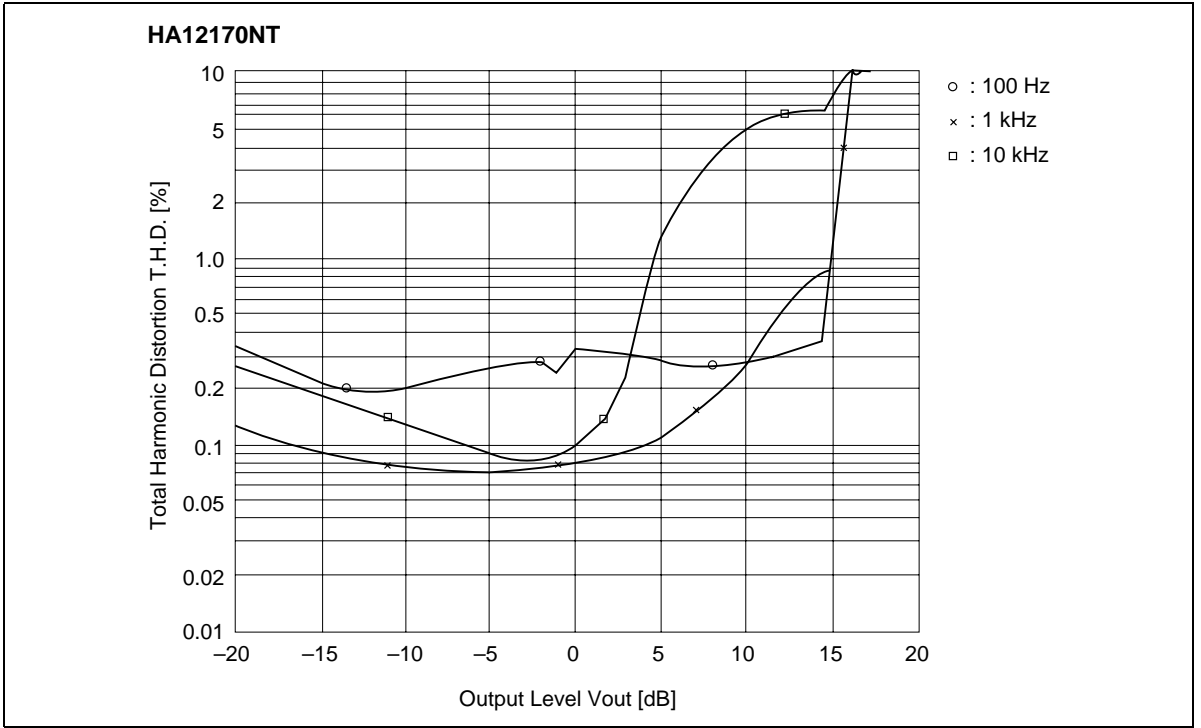

Total Harmonic Distortion vs. Output Level (PB MODE NR-C $V_{cc} = 14$ V)

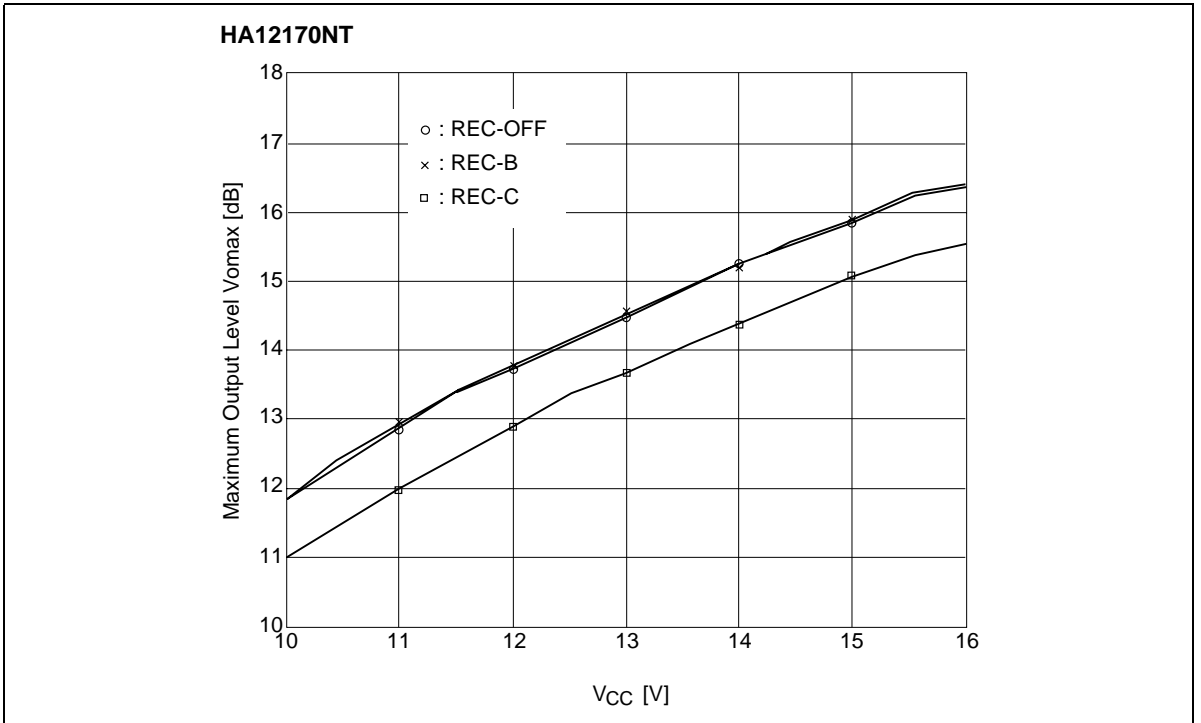

Maximum Output Level vs. Supply Voltage (REC MODE)

HA12141NT, HA12142NT, HA12170NT, HA12161FP, HA12162FP

HA12170NT

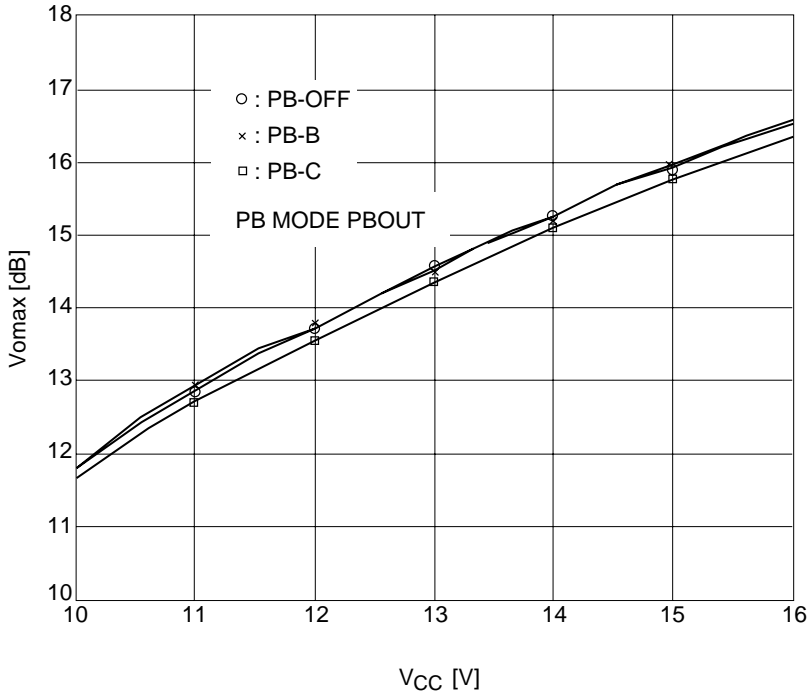

Maximum Output Level vs. Supply Voltage

HA12170NT

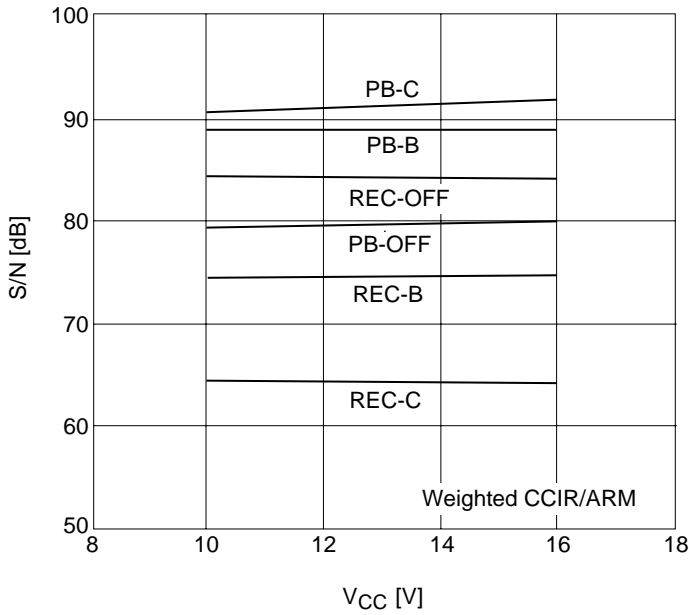

S/N vs. Supply Voltage

HA12141NT, HA12142NT, HA12170NT, HA12161FP, HA12162FP

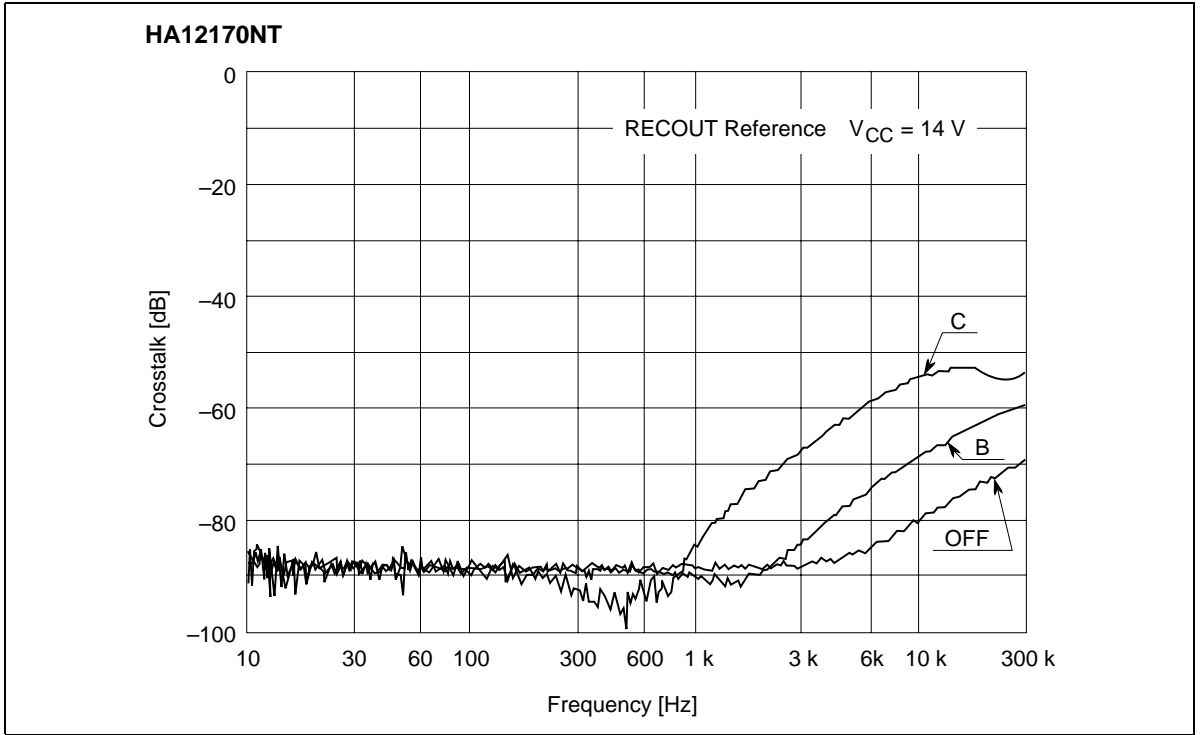

Crosstalk vs. Frequency (REC MODE R↔L)

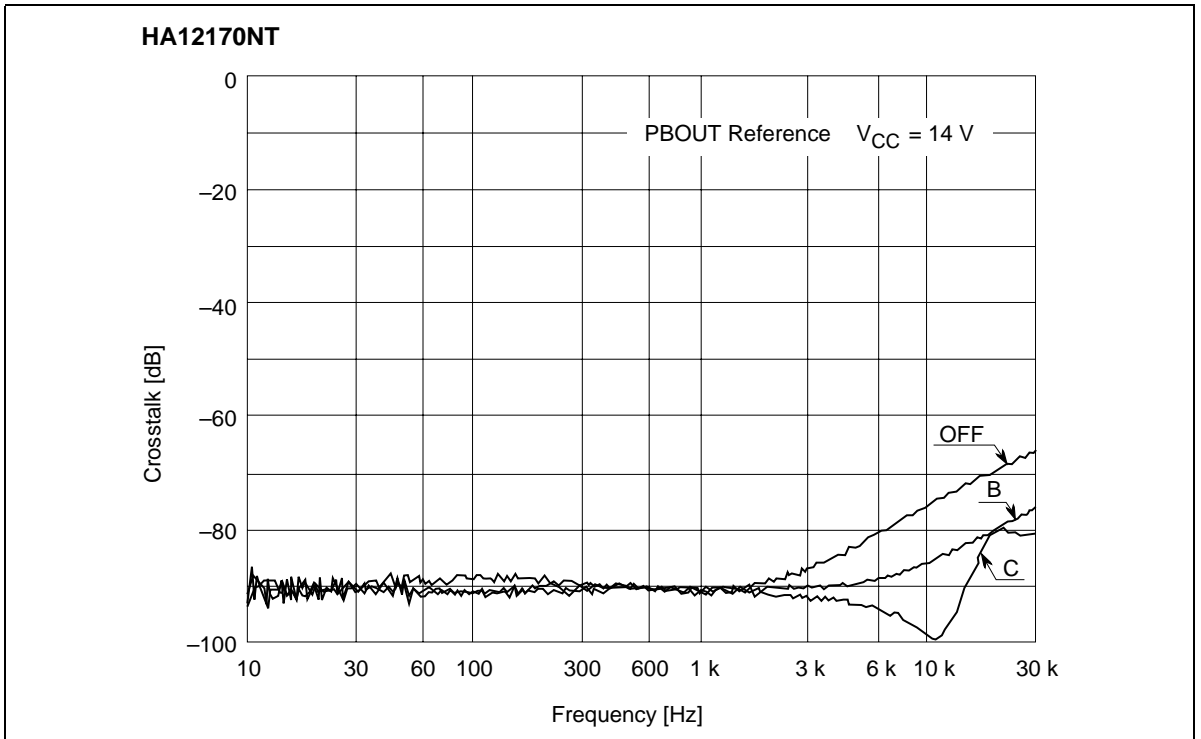

Crosstalk vs. Frequency (PB MODE R↔L)

HA12141NT, HA12142NT, HA12170NT, HA12161FP, HA12162FP

HA12170NT

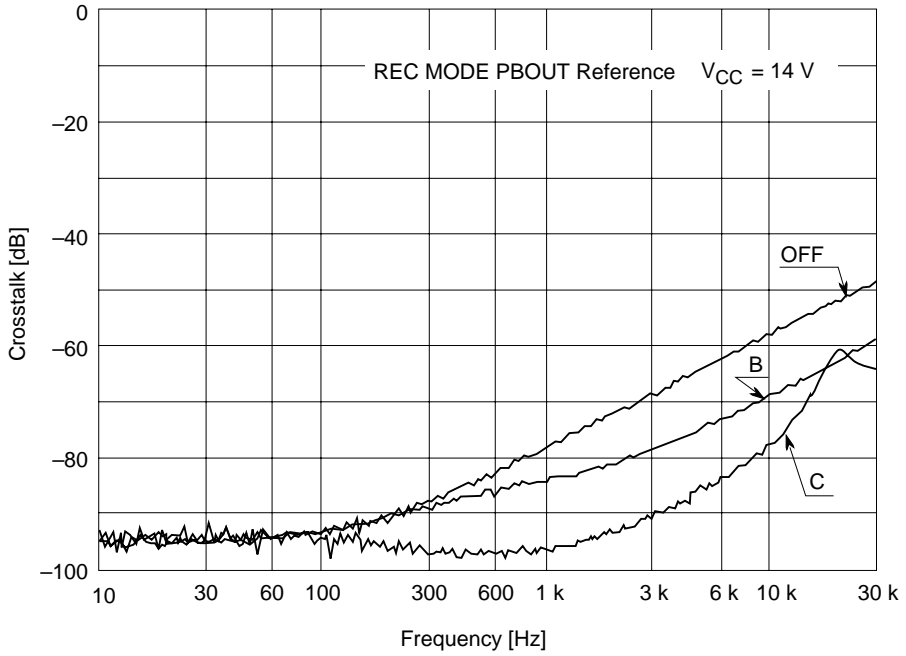

Crosstalk vs. Frequency (REC→PB)

HA12170NT

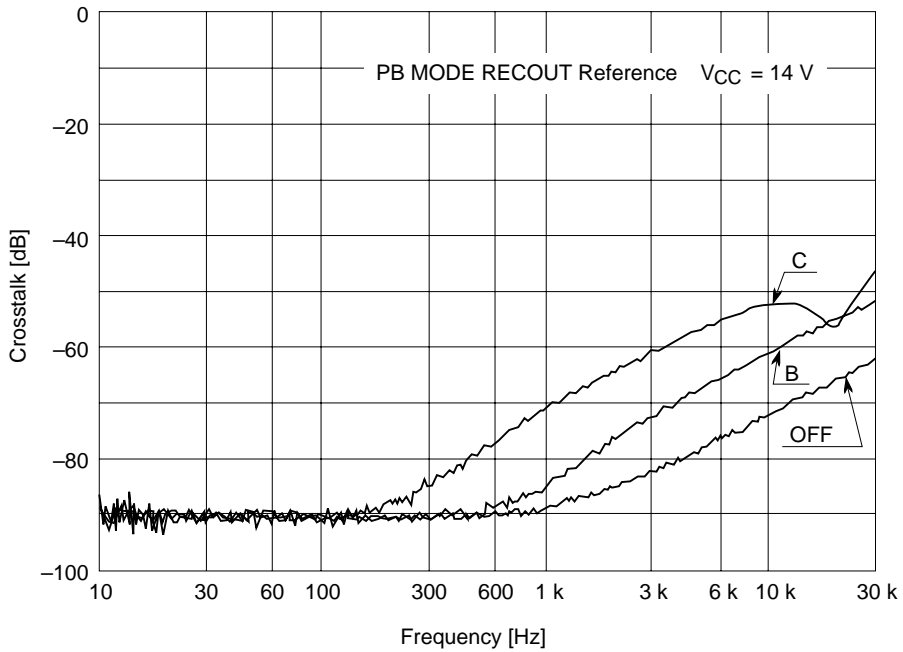

Crosstalk vs. Frequency (PB→REC)

HA12141NT, HA12142NT, HA12170NT, HA12161FP, HA12162FP

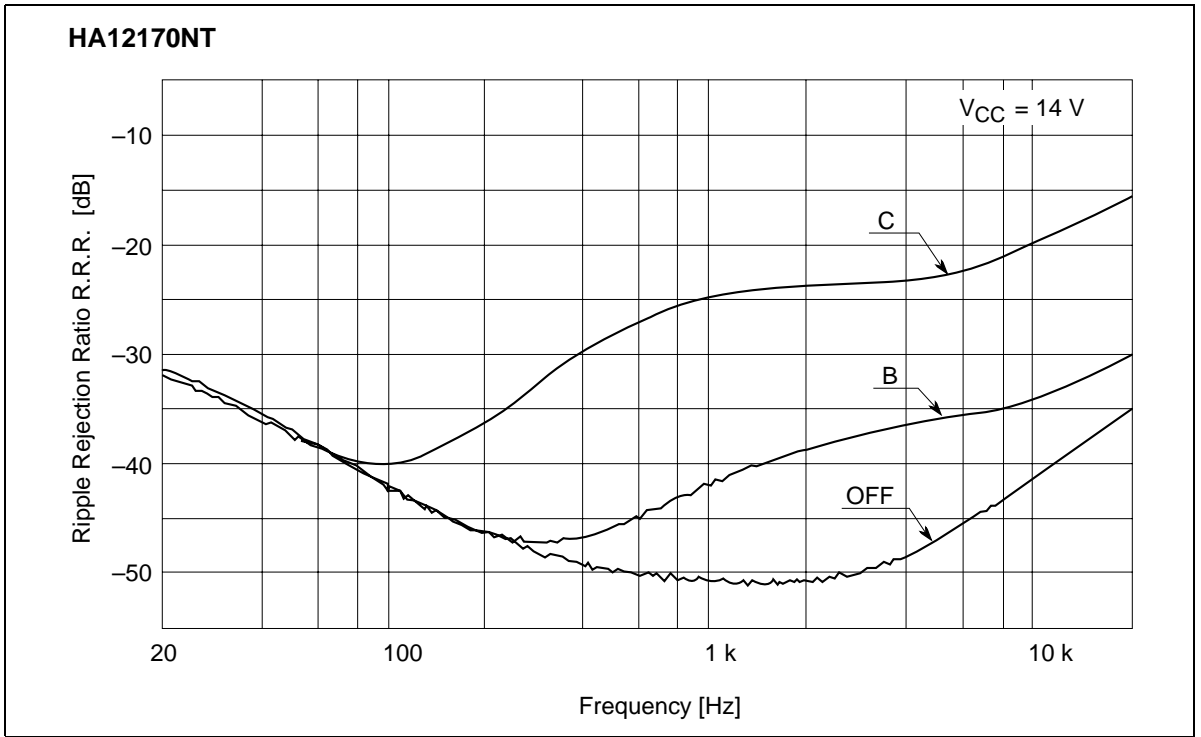

Ripple Rejection Ratio vs. Frequency (REC MODE RECOUT)

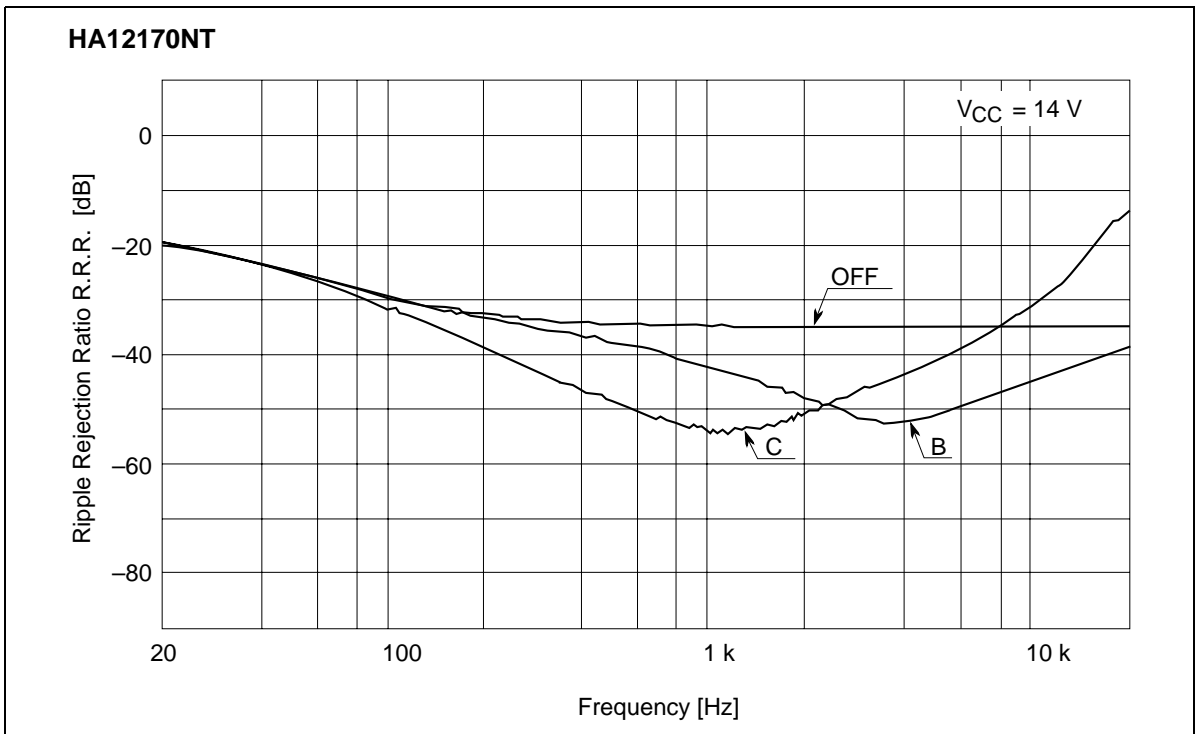

Ripple Rejection Ratio vs. Frequency (PB MODE PBOUT)

HA12141NT, HA12142NT, HA12170NT, HA12161FP, HA12162FP

Functional Description

Power Supply Range

HA12141 series are designed to operate on either single supply or split supply. The operating range of the supply voltage is shown in table 1.

Table 1 Supply Voltage

Type No.	Single supply	Split supply
HA12141NT HA1211161FP	7.5 to 16 volts	± 3.8 to ± 8 volts
HA12142NT HA12162FP	9.5 to 16 volts	± 4.8 to ± 8 volts
HA12170NT	12 to 16 volts	± 6 to ± 8 volts

The lower limit of supply voltage depends on the line output reference level.

The minimum value of the overload margin is specified as 12 dB by Dolby Laboratories.

HA12141 series are provided with 3 line output level, which will permit an optimum overload margin for power supply conditions.

Reference Voltage

For the single supply operation these devices generate the reference voltage of half the supply voltage that is the signal grounds. As the peculiarity of these devices the capacitor for the ripple filter is very small about 1/100 compared with conventional devices.

The reference voltage supplies are provided for the left channel and the right channel. The block-diagram is shown as figure 1.

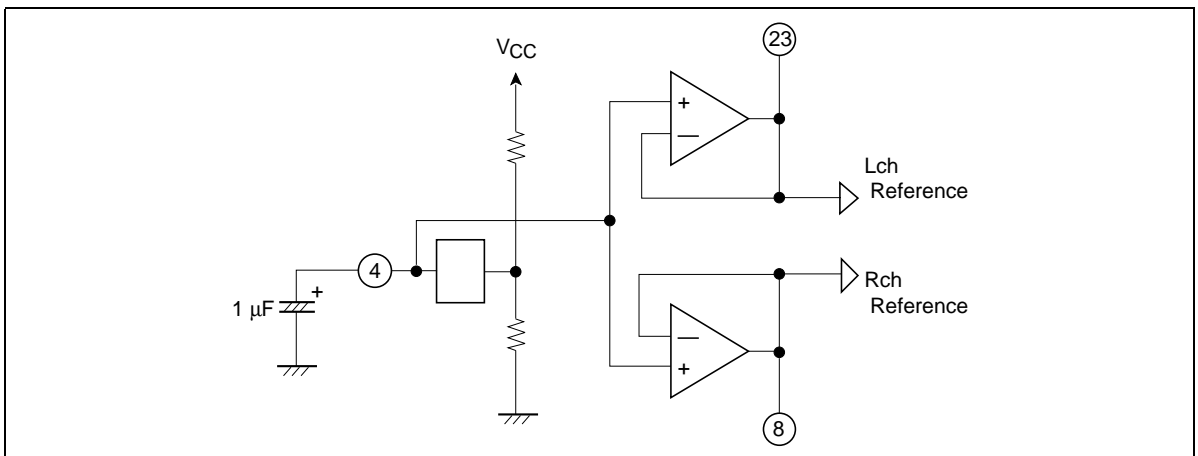

Figure 1 The Block-Diagram of Reference Voltage Supply

HA12141NT, HA12142NT, HA12170NT, HA12161FP, HA12162FP

Operation Mode Control

HA12141 series provide fully electronic switching circuits. The function are controlled by DC voltage and are NR OFF/B/C and PB/REC/MPX.

The switching truth tables are shown in table 2 and table 3.

Table 2 Switching Truth Table (NR OFF/B/C)

Function	Single supply	Split supply	Unit	Note
NR OFF	0 to $V_{cc}/2 - 3$	V_{EE} to -3	V	
B type	$V_{cc}/2 - 0.5$ to $V_{cc}/2 + 0.5$	-0.5 to 0.5	V	*1
C type	$V_{cc}/2 + 3$ to V_{cc}	3 to V_{cc}	V	

Note: 1. These functions are available for being open at NR B mode and REC mode

Table 3 Switching Truth Table (PB/REC/MPX)

Function	Single supply	Split supply	Unit	Note
Play back (Decode mode)	0 to 0.4	V_{EE} to $V_{EE} + 0.4$	V	
Record (Encode mode)	2.5 to $V_{cc}/2 + 0.5$	$V_{EE} + 2.5$ to 0.5	V	*1
MPX-OFF	$V_{cc} - 1$ to V_{cc}	$V_{cc} - 1$ to V_{cc}	V	*2

Notes: 1. These functions are available for being open at NR B mode and REC mode.

2. MPX-OFF mode control Voltage of HA12170NT is available with range from $V_{cc} - 2$ to V_{cc} .

MPX-off mode means that signal from input amp doesn't go through the MPX filter, but signal goes through the SS circuit after being attenuated 3 dB by internal resistor. Refer to figure 2.

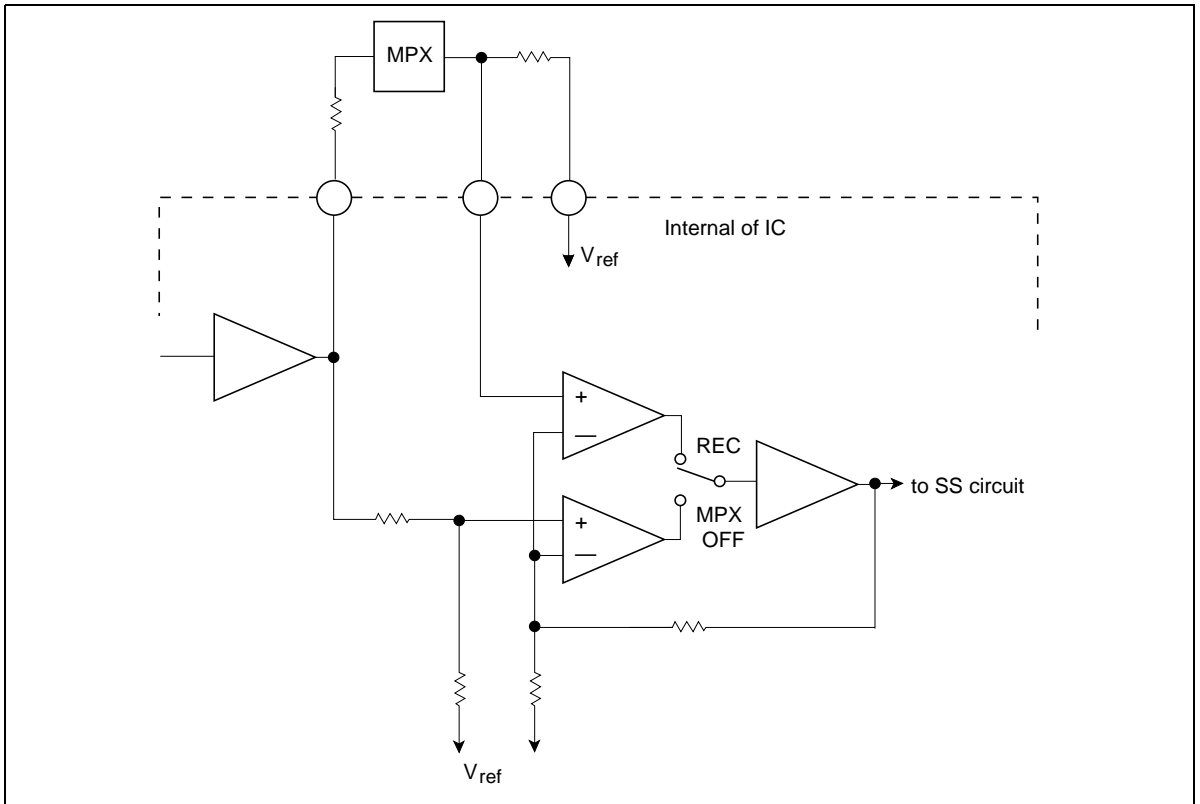

Figure 2 The Block-Diagram of MPX Driving Circuit

It is to be desired that CR time constant circuits are provided at NR OFF/B/C terminal and PB/REC/MPX terminal with time constant from 0.1 sec to 1 sec. If so, it will reduce the switching click noise effectively.

Application Circuits

1. HA12161FP/62FP application

HA12161FP/62FP are developed for exclusive playback of car stereo players.

But these devices are provided with AUX input. This application providing AUX input is available for car stereo players and car stereo cassette decks.

AUX input will be useful for a tuner input. In this case PB/REC/MPX switching operates as the switching of PB/AUX1/AUX2.

HA12141NT, HA12142NT, HA12170NT, HA12161FP, HA12162FP

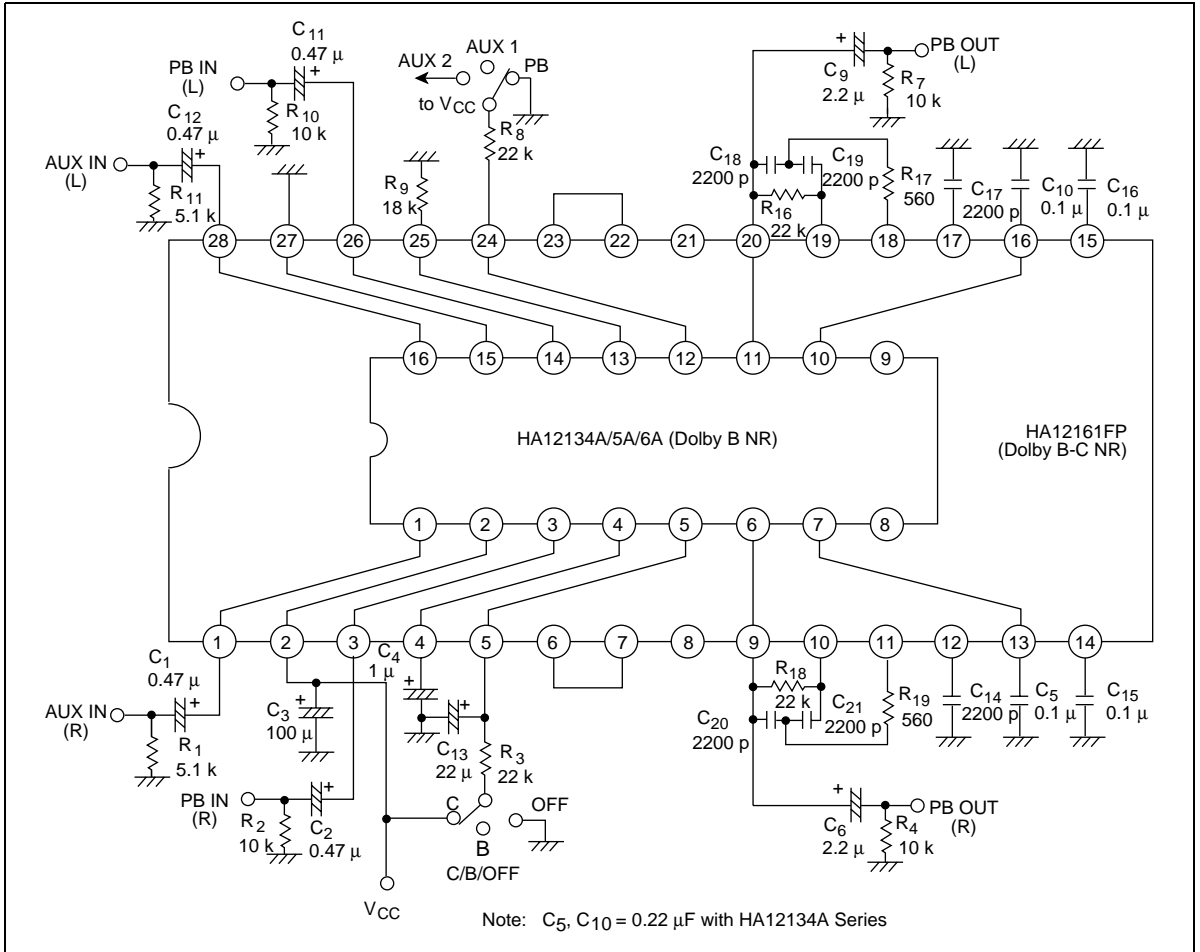

Figure 3 Application of HA12161FP/162FP

We show such application in figure 3. In this application there is 3dB difference between mode AUX1 and mode AUX2 of controlled terminal's pin 24.

Another application is show in figure 4. It is put in filter circuit between pin 6 or 23 and pin 7 or 22.

For example AUX1 mode is AM tuner input and AUX2 mode is FM tuner input respectively.

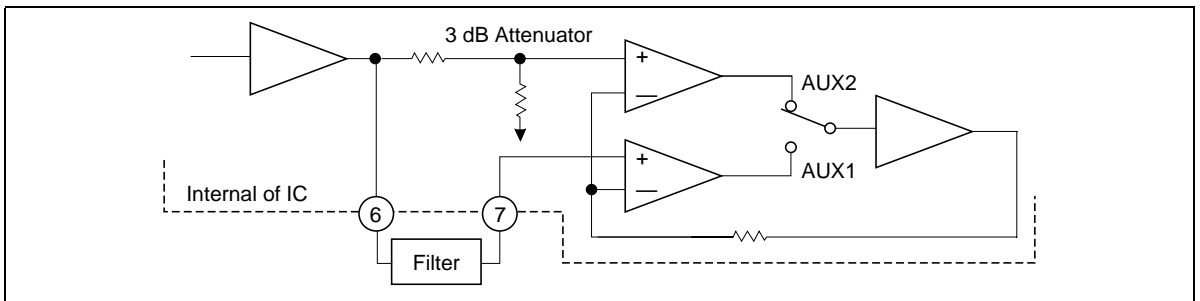

Figure 4 Application of AUX Mode

HA12141NT, HA12142NT, HA12170NT, HA12161FP, HA12162FP

2. Application for dubbing cassette decks.

HA12141 series has unprocessor signal from recording out terminals during playback mode.

So, it is simply applied for dubbing cassette decks.

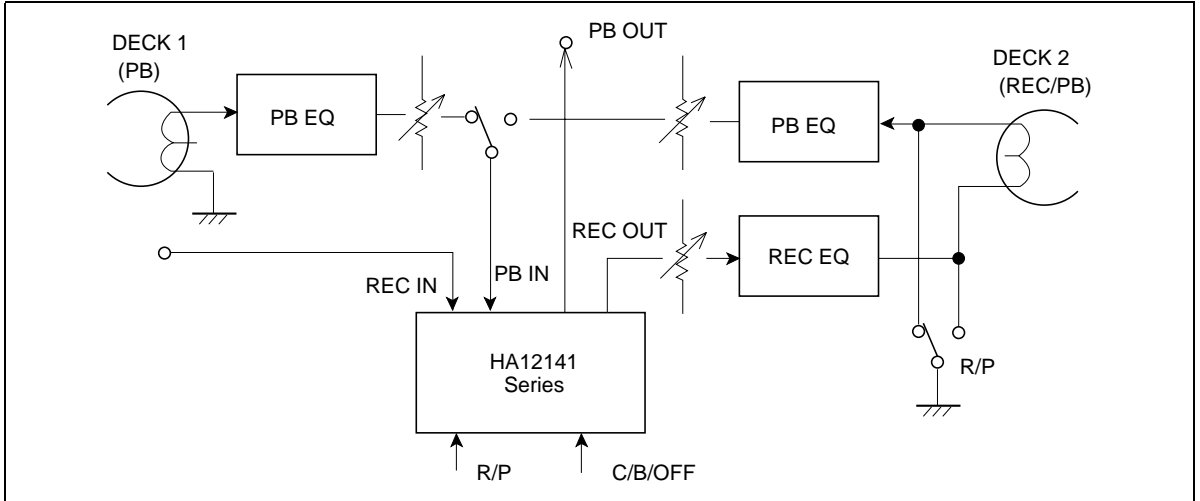
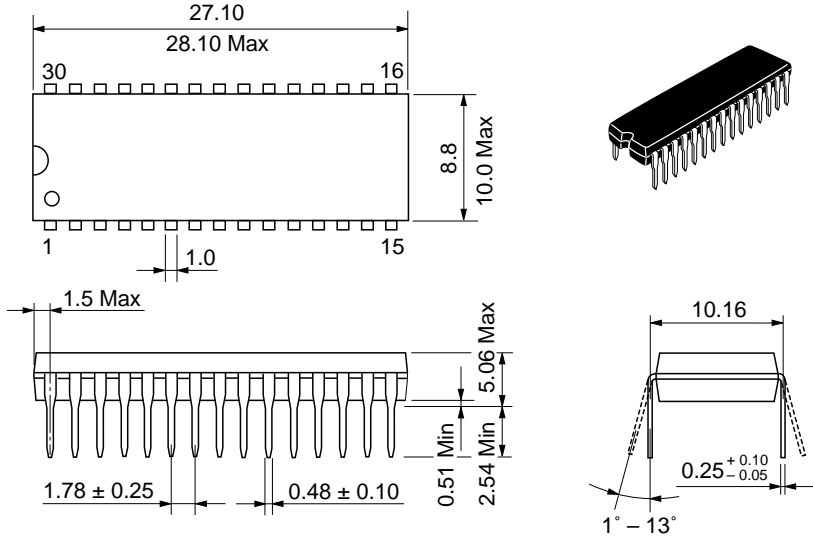

Figure 5 Application for Dubbing Deck

HA12141NT, HA12142NT, HA12170NT, HA12161FP, HA12162FP

Package Dimensions

Unit: mm



Hitachi Code	DP-30S
JEDEC	—
EIAJ	Conforms
Weight (reference value)	1.98 g

Unit: mm

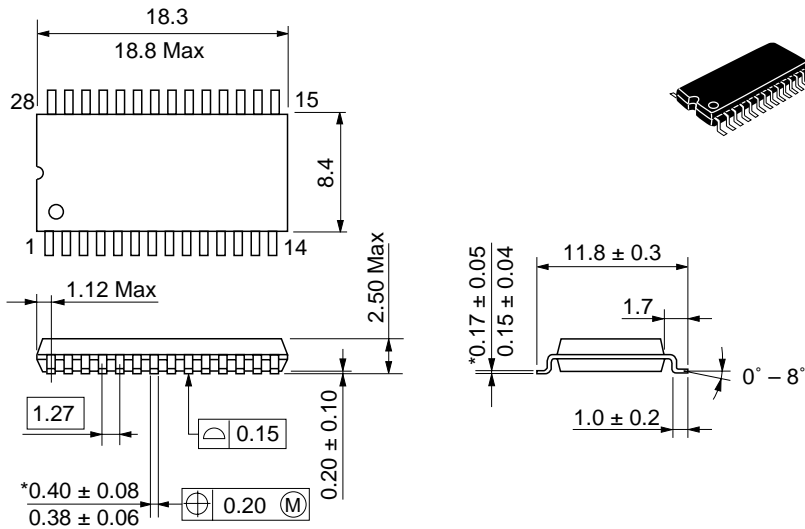

Hitachi Code	FP-28D
JEDEC	Conforms
EIAJ	—
Weight (reference value)	0.7 g

*Dimension including the plating thickness
Base material dimension

Disclaimer

1. Hitachi neither warrants nor grants licenses of any rights of Hitachi's or any third party's patent, copyright, trademark, or other intellectual property rights for information contained in this document. Hitachi bears no responsibility for problems that may arise with third party's rights, including intellectual property rights, in connection with use of the information contained in this document.
2. Products and product specifications may be subject to change without notice. Confirm that you have received the latest product standards or specifications before final design, purchase or use.
3. Hitachi makes every attempt to ensure that its products are of high quality and reliability. However, contact Hitachi's sales office before using the product in an application that demands especially high quality and reliability or where its failure or malfunction may directly threaten human life or cause risk of bodily injury, such as aerospace, aeronautics, nuclear power, combustion control, transportation, traffic, safety equipment or medical equipment for life support.
4. Design your application so that the product is used within the ranges guaranteed by Hitachi particularly for maximum rating, operating supply voltage range, heat radiation characteristics, installation conditions and other characteristics. Hitachi bears no responsibility for failure or damage when used beyond the guaranteed ranges. Even within the guaranteed ranges, consider normally foreseeable failure rates or failure modes in semiconductor devices and employ systemic measures such as fail-safes, so that the equipment incorporating Hitachi product does not cause bodily injury, fire or other consequential damage due to operation of the Hitachi product.
5. This product is not designed to be radiation resistant.
6. No one is permitted to reproduce or duplicate, in any form, the whole or part of this document without written approval from Hitachi.
7. Contact Hitachi's sales office for any questions regarding this document or Hitachi semiconductor products.

Sales Offices

HITACHI

Hitachi, Ltd.

Semiconductor & Integrated Circuits.
Nippon Bldg., 2-6-2, Ohte-machi, Chiyoda-ku, Tokyo 100-0004, Japan
Tel: Tokyo (03) 3270-2111 Fax: (03) 3270-5109

URL NorthAmerica : <http://semiconductor.hitachi.com/>
 Europe : <http://www.hitachi-eu.com/hel/ecg>
 Asia : <http://sicapac.hitachi-asia.com>
 Japan : <http://www.hitachi.co.jp/Sicd/indx.htm>

For further information write to:

Hitachi Semiconductor
(America) Inc.
179 East Tasman Drive,
San Jose, CA 95134
Tel: <1> (408) 433-1990
Fax: <1> (408) 433-0223

Hitachi Europe GmbH
Electronic Components Group
Dornacher Straße 3
D-85622 Feldkirchen, Munich
Germany
Tel: <49> (89) 9 9180-0
Fax: <49> (89) 9 29 30 00

Hitachi Europe Ltd.
Electronic Components Group.
Whitebrook Park
Lower Cookham Road
Maidenhead
Berkshire SL6 8YA, United Kingdom
Tel: <44> (1628) 585000
Fax: <44> (1628) 585160

Hitachi Asia Ltd.
Hitachi Tower
16 Collyer Quay #20-00,
Singapore 049318
Tel : <65>-538-6533/538-8577
Fax : <65>-538-6933/538-3877
URL : <http://www.hitachi.com.sg>

Hitachi Asia Ltd.
(Taipei Branch Office)
4/F, No. 167, Tun Hwa North Road,
Hung-Kuo Building,
Taipei (105), Taiwan
Tel : <886>-(2)-2718-3666
Fax : <886>-(2)-2718-8180
Telex : 23222 HAS-TP
URL : <http://www.hitachi.com.tw>

Hitachi Asia (Hong Kong) Ltd.
Group III (Electronic Components)
7/F., North Tower,
World Finance Centre,
Harbour City, Canton Road
Tsim Sha Tsui, Kowloon,
Hong Kong
Tel : <852>-(2)-735-9218
Fax : <852>-(2)-730-0281
URL : <http://www.hitachi.com.hk>

Copyright © Hitachi, Ltd., 2000. All rights reserved. Printed in Japan.
Colophon 2.0