



LS404

HIGH PERFORMANCE QUAD OPERATIONAL AMPLIFIER

- SINGLE OR SPLIT SUPPLY OPERATION
- LOW POWER CONSUMPTION
- SHORT CIRCUIT PROTECTION
- LOW DISTORTION, LOW NOISE
- HIGH GAIN-BANDWIDTH PRODUCT
- HIGH CHANNEL SEPARATION

DESCRIPTION

The LS404 is a high performance quad operational amplifier with frequency and phase compensation built into the chip. The internal phase compensation allows stable operation as voltage follower in spite of its high Gain-Bandwidth Product.

The circuit presents very stable electrical characteristics over the entire supply voltage range, and is particularly intended for professional and telecom applications (active filter, etc).

The patented input stage circuit allows small input signal swings below the negative supply voltage and prevents phase inversion when the inputs are over drivers.

ORDER CODE

Part Number	Temperature Range	Package	
		N	D
LS404C	0°C, +70°C	•	•
LS404I	-40°C, +105°C	•	•
LS404M	-55°C, +125°C	•	•

Example : LS204CN

N = Dual in Line Package (DIP)
D = Small Outline Package (SO) - also available in Tape & Reel (DT)

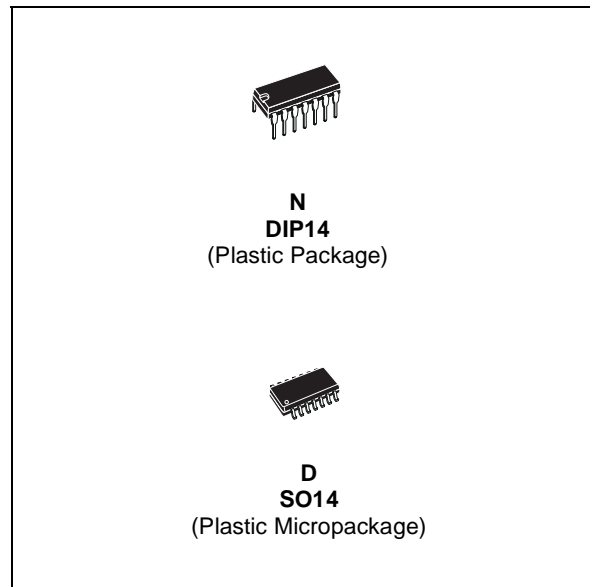

PIN CONNECTIONS (top view)

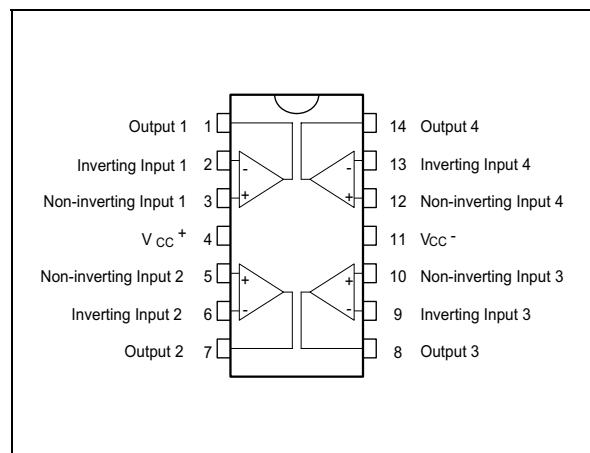

SCHEMATIC DIAGRAM (1/4 LS404)

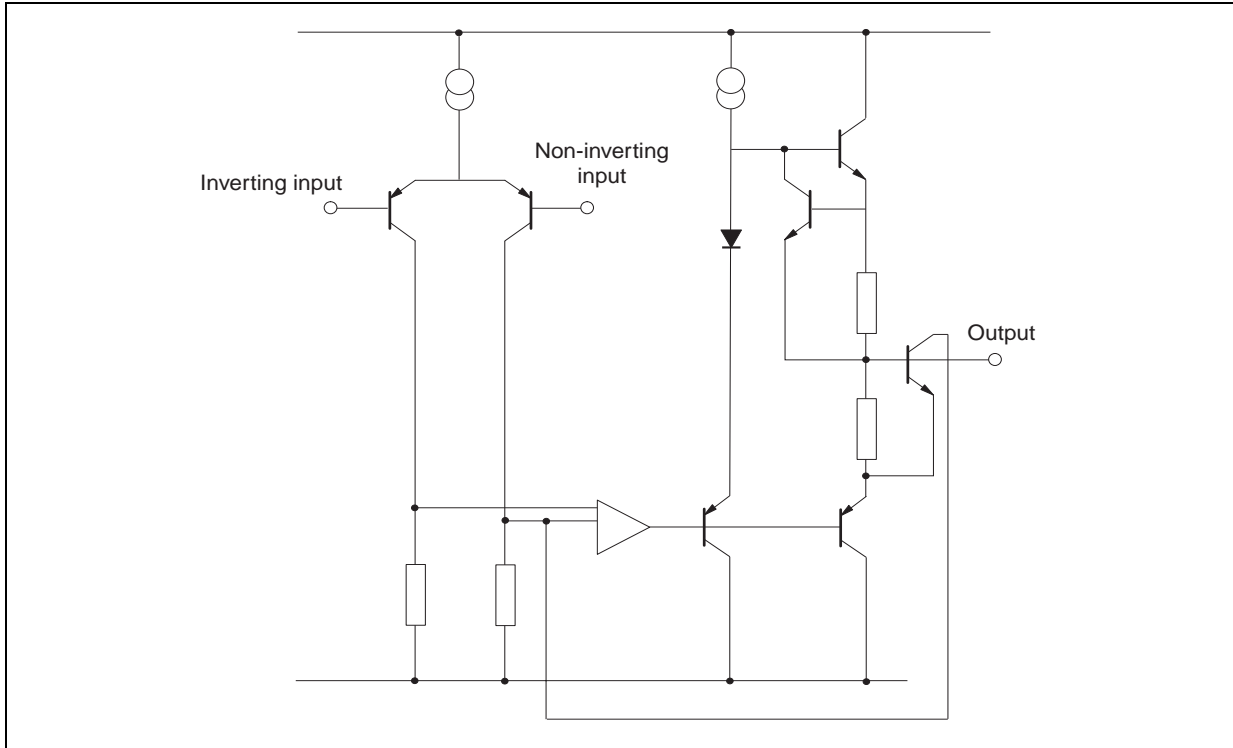

ABSOLUTE MAXIMUM RATINGS

Symbol	Parameter		Value	Unit
V_{CC}	Supply voltage		± 18	V
V_i	Input Voltage	Positive Negative	$+V_{CC}$ $-V_{CC} - 0.5$	V
V_{id}	Differential Input Voltage		$\pm(V_{CC} - 1)$	V
T_{oper}	Operating Temperature Range	LS204C LS204I LS204I	0 to +70 -40 to +105 -55 to +125	$^{\circ}\text{C}$
P_{tot}	Power Dissipation at $T_{amb} = 70^{\circ}\text{C}$		400	mW
T_{stg}	Storage Temperature Range		-65 to +150	$^{\circ}\text{C}$

ELECTRICAL CHARACTERISTICS $V_{CC} = \pm 15V$, $T_{amb} = 25^{\circ}C$ (unless otherwise specified)

Symbol	Parameter	LS4041 - LS404M			LS404C			Unit
		Min.	Typ.	Max.	Min.	Typ.	Max.	
I_{CC}	Supply Current		1.3	2		1.5	3	mA
I_{ib}	Input Bias Current		50	200		100	300	nA
R_i	Input Resistance ($f = 1kHz$)		1			1		$M\Omega$
V_{io}	Input Offset Voltage ($R_s \leq 10k\Omega$)		0.7	2.5		0.5	5	mV
DV_{io}	Input Offset Voltage Drift ($R_s \leq 10k\Omega$) $T_{min} < T_{op} < T_{max}$		5			5		$\mu V/^{\circ}C$
I_{io}	Input Offset Current		10	40		20	80	nA
DI_{io}	Input Offset Current Drift $T_{min} < T_{op} < T_{max}$		0.08			0.1		$nA/^{\circ}C$
I_{os}	Output Short-circuit Current		23			23		mA
A_{vd}	Large Signal Voltage Gain $R_L = 2k\Omega$, $V_{CC} = \pm 15V$ $V_{CC} = \pm 4V$	90	100 95		86	100 95		dB
GBP	Gain Bandwidth Product $f = 100kHz$, $R_L = 2k$, $C_L = 100pF$	1.8	3		1.5	2.5		MHz
e_n	Equivalent Input Noise Voltage $f = 1kHz$, $R_s = 50\Omega$ $R_s = 1k\Omega$ $R_s = 10k\Omega$		8 10 18	15		10 12 20		$\frac{nV}{\sqrt{Hz}}$
THD	Total Harmonic Distortion Unity Gain $R_L = 2k\Omega$, $V_o = 2V_{pp}$ $f = 1kHz$ $f = 20kHz$		0.01 0.03	0.4		0.01 0.03		%
$\pm V_{opp}$	Output Voltage Swing $R_L = 2k\Omega$, $V_{CC} = \pm 15V$ $V_{CC} = \pm 4V$	± 13	± 3		± 13	± 3		V
V_{opp}	Large Signal Voltage Swing $f = 10kHz$, $R_L = 10k\Omega$ $R_L = 1k\Omega$		22 20			22 20		V_{pp}
SR	Slew Rate ($R_L = 2k\Omega$, unity gain)	0.8	1.5			1		$V/\mu s$
SVR	Supply Voltage Rejection Ratio $V_{ic} = 1V$, $f = 100Hz$	90	94		86	90		dB
CMR	Common Mode Rejection Ratio $V_{ic} = 10V$	90	94		86	90		dB
V_{o1}/V_{o2}	Channel Separation ($f = 1kHz$)	100	120			120		dB

Figure 1 : Supply Current versus Supply Voltage

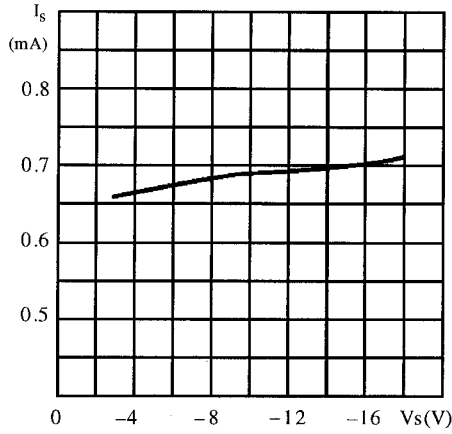

Figure 2 : Supply Current versus Ambient Temperature

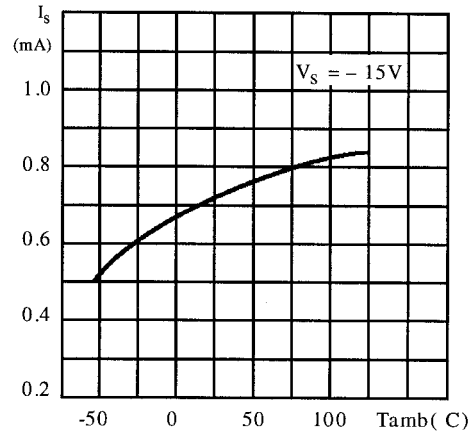

Figure 3 : Output Short Circuit Current versus Ambient Temperature

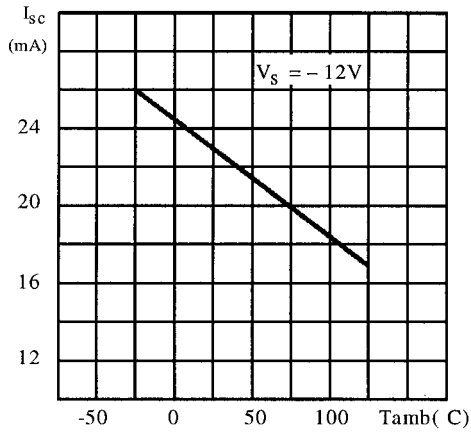

Figure 4 : Open Loop Frequency and Phase Response

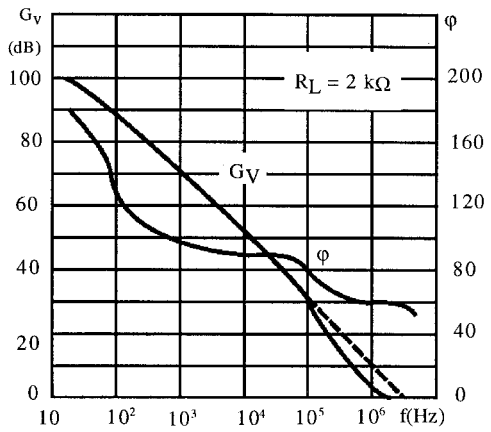

Figure 5 : Output Loop Gain versus Ambient Temperature

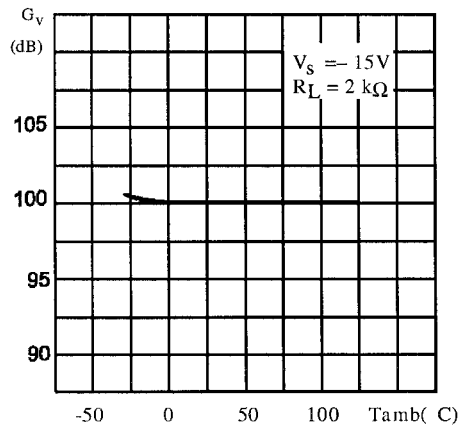

Figure 6 : Supply Voltage Rejection versus Frequency

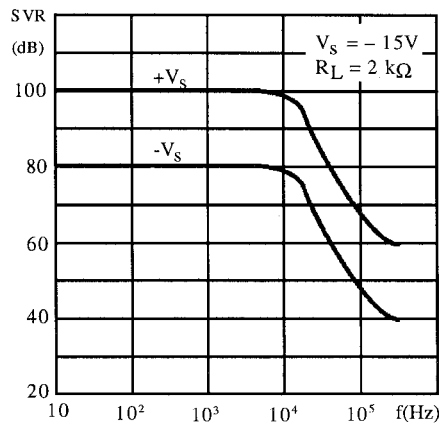

Figure 7 : Large Signal Frequency Response

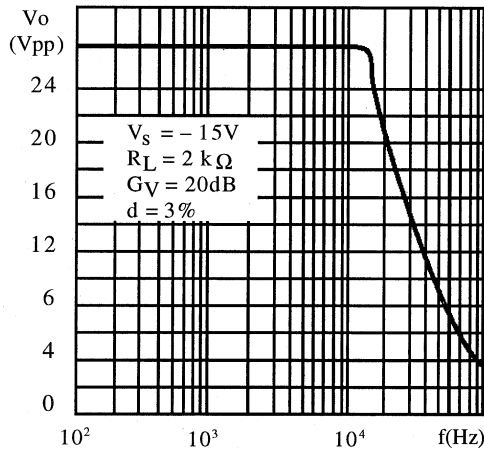

Figure 8 : Output Voltage Swing versus Load Resistance

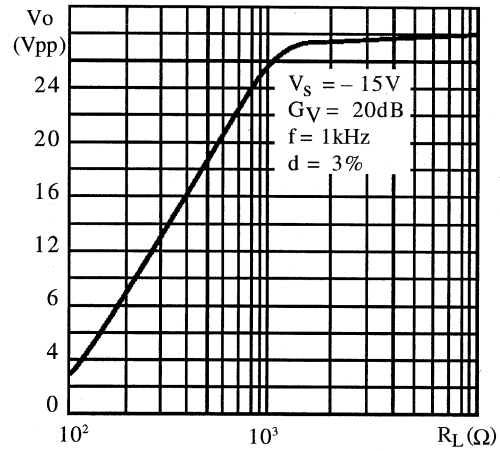

Figure 9 : Total Input Noise versus Frequency

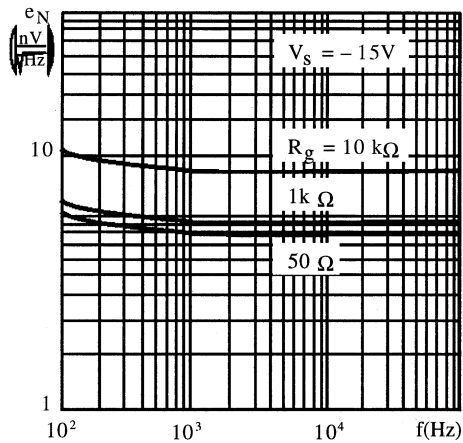

Figure 10 : Amplitude Response

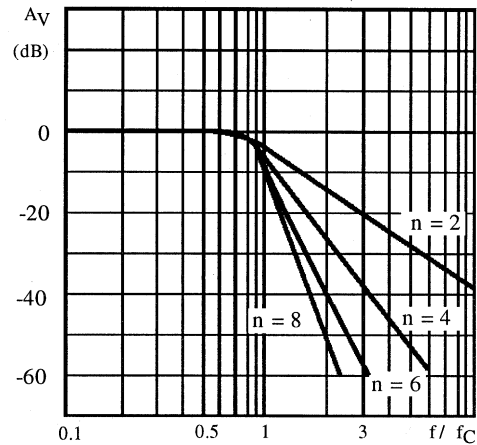

Figure 11 : Amplitude Response

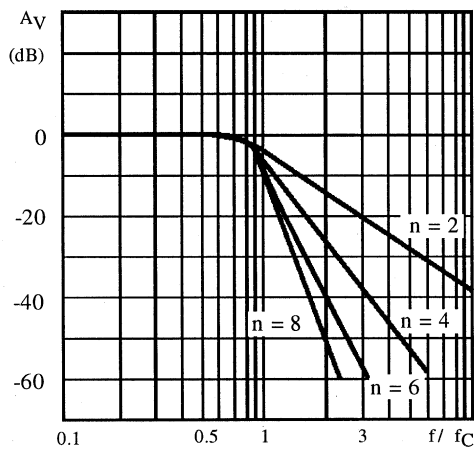
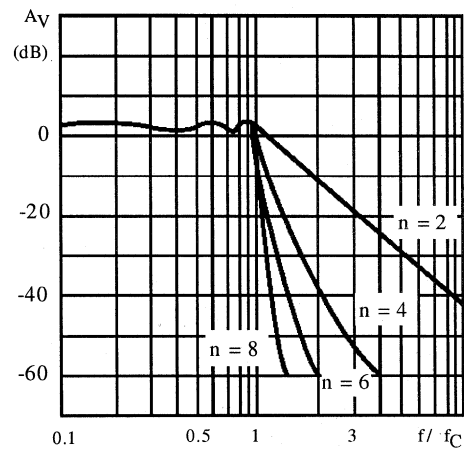

Figure 12 : Amplitude Response (±1dB ripple)



APPLICATION INFORMATION: Active low-pass filter

BUTTERWORTH

The Butterworth is a "maximally flat" amplitude response filter (figure 10) Butterworth filters are used for filtering signals in data acquisition systems to prevent aliasing errors in samples-data applications and for general purpose low-pass filtering.

The cut-off frequency F_c , is the frequency at which the amplitude response is down 3dB. The attenuation rate beyond the cutoff frequency is $n6$ dB per octave of frequency where n is the order (number of poles) of the filter.

Other characteristics :

- Flattest possible amplitude response
- Excellent gain accuracy at low frequency end of passband

BESSEL

The Bessel is a type of "linear phase" filter. Because of their linear phase characteristics, these filters approximate a constant time delay over a limited frequency range. Bessel filters pass transient waveforms with a minimum of distortion. They are also used to provide time delays for low pass filtering of modulated waveforms and as a "running average" type filter.

The maximum phase shift is $\frac{-n\pi}{2}$ radians where

n is the order (number of poles) of the filter. The cut-off frequency f_c , is defined as the frequency at which the phase shift is one half of this value.

The table below shows the typical overshoot and settling time response of the low pass filters to a step input.

	Number of Poles	Peak Overshoot	Settling Time (% of final value)		
		% Overshoot	±1%	±0.1%	±0.01%
Butterworth	2	4	1.1 F_c sec.	1.7 F_c sec.	1.9 F_c sec.
	4	11	1.7/ f_c	2.8/ f_c	3.8/ f_c
	6	14	2.4/ f_c	3.9S/ f_c	5.0S/ f_c
	8	14	3.1/ f_c	5.1/ f_c	7.1/ f_c
Bessel	2	0.4	0.8/ f_c	1.4/ f_c	1.7/ f_c
	4	0.8	1.0/ f_c	1.8/ f_c	2.4/ f_c
	6	0.6	1.3/ f_c	2.1/ f_c	2.7/ f_c
	8	0.1	1.6/ f_c	2.3/ f_c	3.2/ f_c
Chebyshev (ripple ±0.25dB)	2	11	1.1/ f_c	1.6/ f_c	-
	4	18	3.0/ f_c	5.4/ f_c	-
	6	21	5.9/ f_c	10.4/ f_c	-
	8	23	8.4/ f_c	16.4/ f_c	-
Chebyshev (ripple ±1dB)	2	21	1.6/ f_c	2.7/ f_c	-
	4	28	4.8/ f_c	8.4/ f_c	-
	6	32	8.2/ f_c	16.3/ f_c	-
	8	34	11.6/ f_c	24.8/ f_c	-

For accurate delay, the cut-off frequency should be twice the maximum signal frequency.

The following table can be used to obtain the -3dB frequency of the filter.

	2 Pole	4 Pole	6 Pole	8 Pole
-3dB Frequency	0.77 f_c	0.67 f_c	0.57 f_c	0.50 f_c

Other characteristics :

- Selectivity not as great as Chebyshev or Butterworth
- Very little overshoot response to step inputs
- Fast rise time

CHEBYSCHEV

Chebyshev filters have greater selectivity than either Bessel or Butterworth at the expense of ripple in the passband (figure 11).

Chebyshev filters are normally designed with peak-to-peak ripple values from 0.2dB to 2dB.

Increased ripple in the passband allows increased attenuation above the cut-off frequency.

The cut-off frequency is defined as the frequency at which the amplitude response passes through the specified maximum ripple band and enters the stop band.

Other characteristics :

- Greater selectivity
- Very non-linear phase response
- High overshoot response to step inputs

Design of 2nd order active low pass filter (Sallen and Key configuration unity gain op-amp)

Fixed $R = R1 = R2$, we have (see figure 13)

$$C1 = \frac{1}{R} \frac{\xi}{\omega_c}$$

$$C2 = \frac{1}{R} \frac{1}{\xi \omega_c}$$

Figure 13 : Filter Configuration

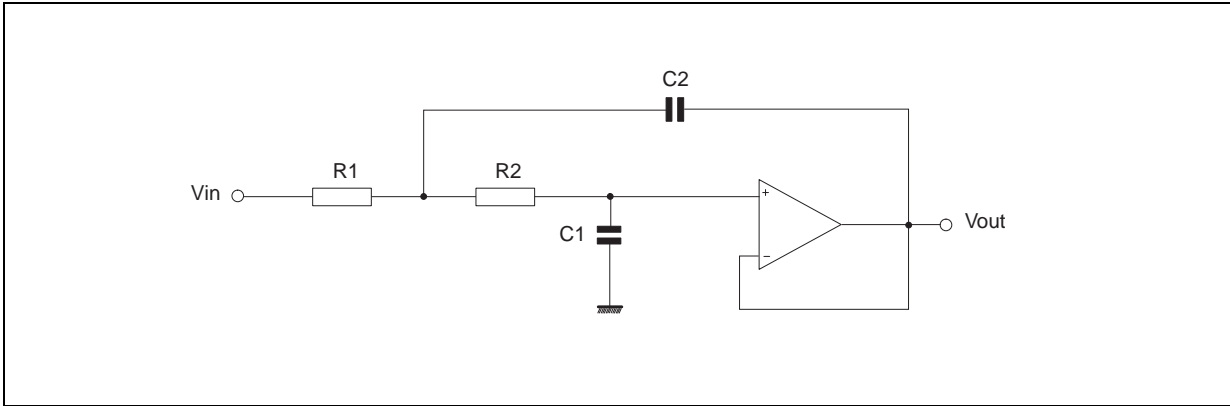

Three parameters are needed to characterize the frequency and phase response of a 2nd order active filter: the gain (G_v), the damping factor (ξ) or the Q factor ($Q = 2 \xi^{-1}$), and the cutoff frequency (f_c).

The higher order response are obtained with a series of 2nd order sections. A simple RC section is introduced when an odd filter is required. The choice of ' ξ ' (or Q factor) determines the filter response (see table 1).

Table 1

Filter Response	ξ	Q	Cutoff Frequency f_c
Bessel	$\frac{\sqrt{3}}{2}$	$\frac{\sqrt{1}}{3}$	Frequency at which Phase Shift is -90°
Butterworth	$\frac{\sqrt{2}}{2}$	$\frac{\sqrt{1}}{2}$	Frequency at which $G_v = -3\text{dB}$
Chebyshev	$\frac{\sqrt{2}}{2}$	$\frac{\sqrt{1}}{2}$	Frequency at which the amplitude response passes through specified max. ripple band and enters the stop bank.

EXAMPLE

Figure 14 : 5th Order Low-pass Filter (Butterworth) with Unity Gain configuration

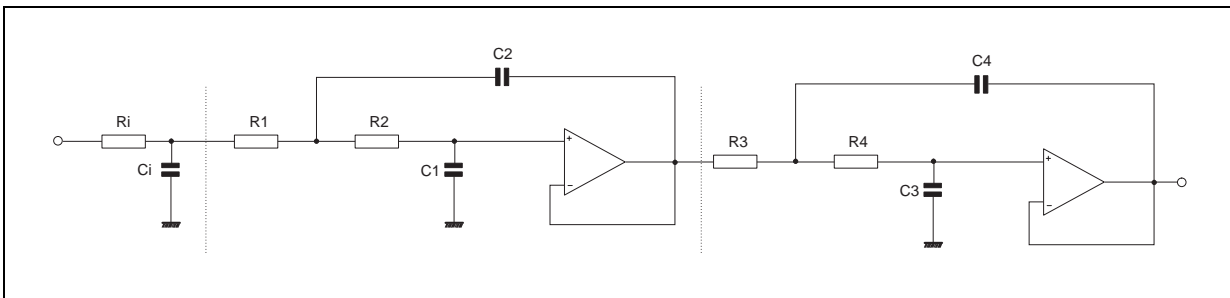

In the circuit of figure 14, for $f_c = 3.4\text{kHz}$ and $R_i = R_1 = R_2 = R_3 = 10\text{k}\Omega$, we obtain:

$$C_i = 1.354 \frac{1}{R} \frac{1}{2\pi f_c} = 6.33\text{nF}$$

$$C_1 = 0.421 \frac{1}{R} \frac{1}{2\pi f_c} = 1.97\text{nF}$$

$$C_2 = 1.753 \frac{1}{R} \frac{1}{2\pi f_c} = 8.20\text{nF}$$

$$C_3 = 0.309 \frac{1}{R} \frac{1}{2\pi f_c} = 1.45\text{nF}$$

$$C_4 = 3.325 \frac{1}{R} \frac{1}{2\pi f_c} = 15.14\text{nF}$$

The attenuation of the filter is 30dB at 6.8kHz and better than 60dB at 15kHz.

The same method, referring to table 2 and figure 15 is used to design high-pass filter. In this case the damping factor is found by taking the reciprocal of the numbers in table 2. For $f_c = 5\text{kHz}$ and $C_i = C_1 = C_2 = C_3 = 1\text{nF}$ we obtain:

$$R_i = \frac{1}{0.354} \frac{1}{C} \frac{1}{2\pi f_c} = 25.5\text{k}\Omega$$

$$R_1 = \frac{1}{0.421} \frac{1}{C} \frac{1}{2\pi f_c} = 75.6\text{k}\Omega$$

$$R_2 = \frac{1}{1.753} \frac{1}{C} \frac{1}{2\pi f_c} = 18.2\text{k}\Omega$$

$$R_3 = \frac{1}{0.309} \frac{1}{C} \frac{1}{2\pi f_c} = 103\text{k}\Omega$$

$$R_4 = \frac{1}{3.325} \frac{1}{C} \frac{1}{2\pi f_c} = 9.6\text{k}\Omega$$

Table 2 : Damping Factor for Low-pass Butterworth Filters

Order	C_i	C_1	C_2	C_3	C_4	C_5	C_6	C_7	C_8
2		0.707	1.41						
3	1.392	0.202	3.54						
4		0.92	1.08	0.38	2.61				
5	1.354	0.421	1.75	0.309	3.235				
6		0.966	1.035	0.707	1.414	0.259	3.86		
7	1.336	0.488	1.53	0.623	1.604	0.222	4.49		
8		0.98	1.02	0.83	1.20	0.556	1.80	0.195	5.125

Figure 15 : 5th Order High-pass Filter (Butterworth) with Unity Gain configuration

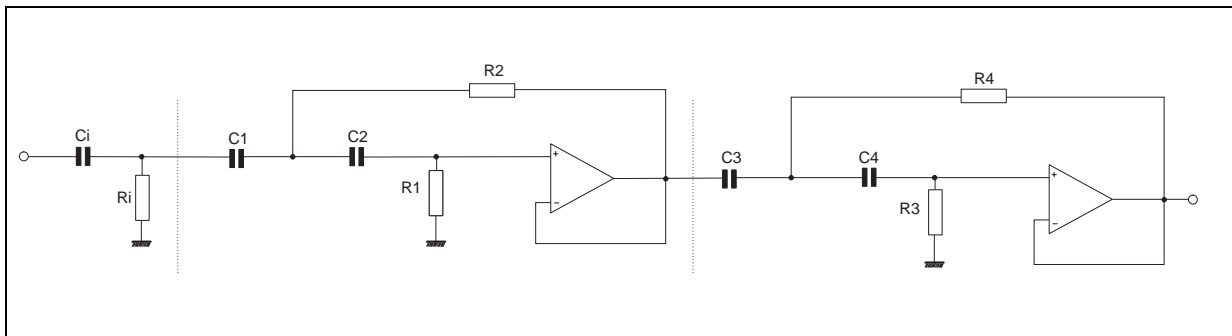

Figure 16 : Multiple Feedback 8-pole Bandpass Filter

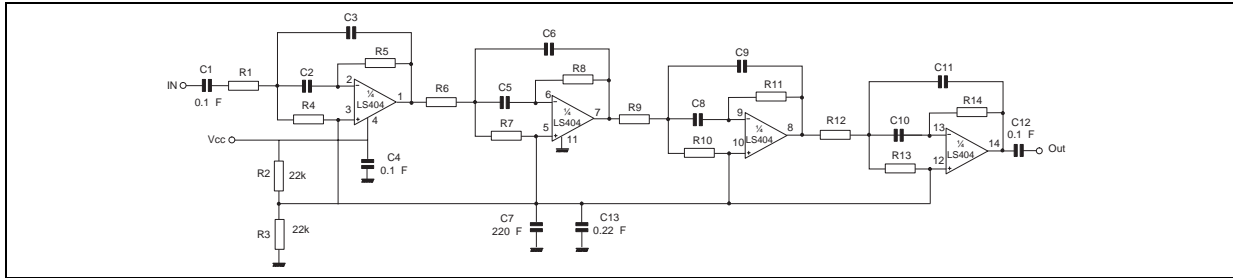
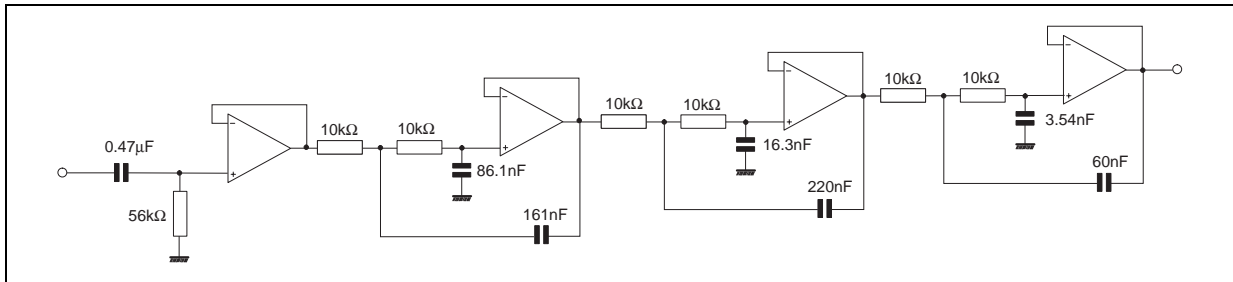

Figure 17 : Six pole 355Hz Low-pass Filter (chebychev type)



This is a - pole Chebyshev type with $\pm 0.25\text{dB}$ ripple in the passband. A decoupling stage is used to avoid the influence of the input impedance on the filter's characteristics. The attenuation is about 55dB at 710Hz and reaches 80dB at 1065Hz. the in band attenuation is limited in practise to the $\pm 0.25\text{dB}$ ripple and does not exceed 0.5dB at 0.9fc.

Figure 18 : Subsonic Filter ($G_v = 0\text{dB}$)

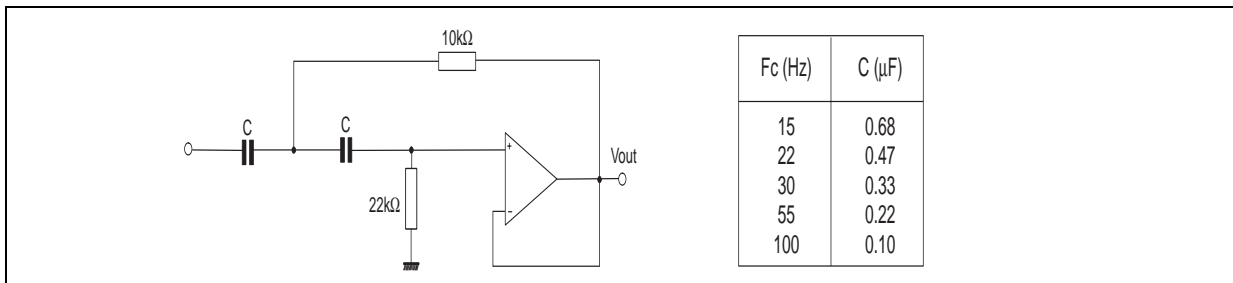
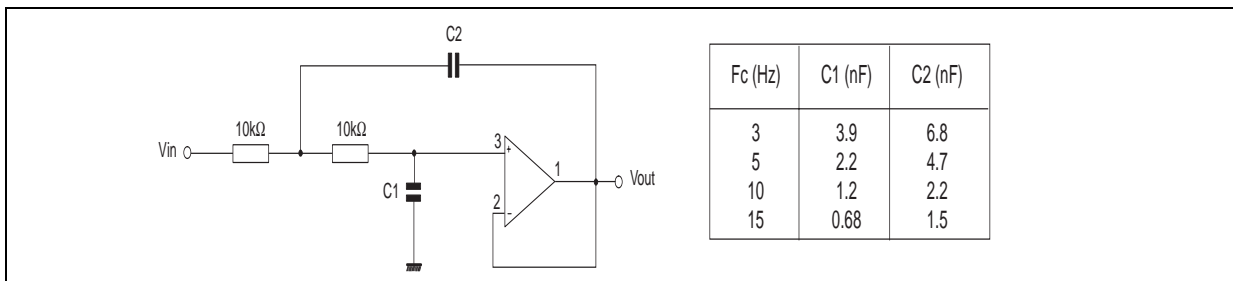
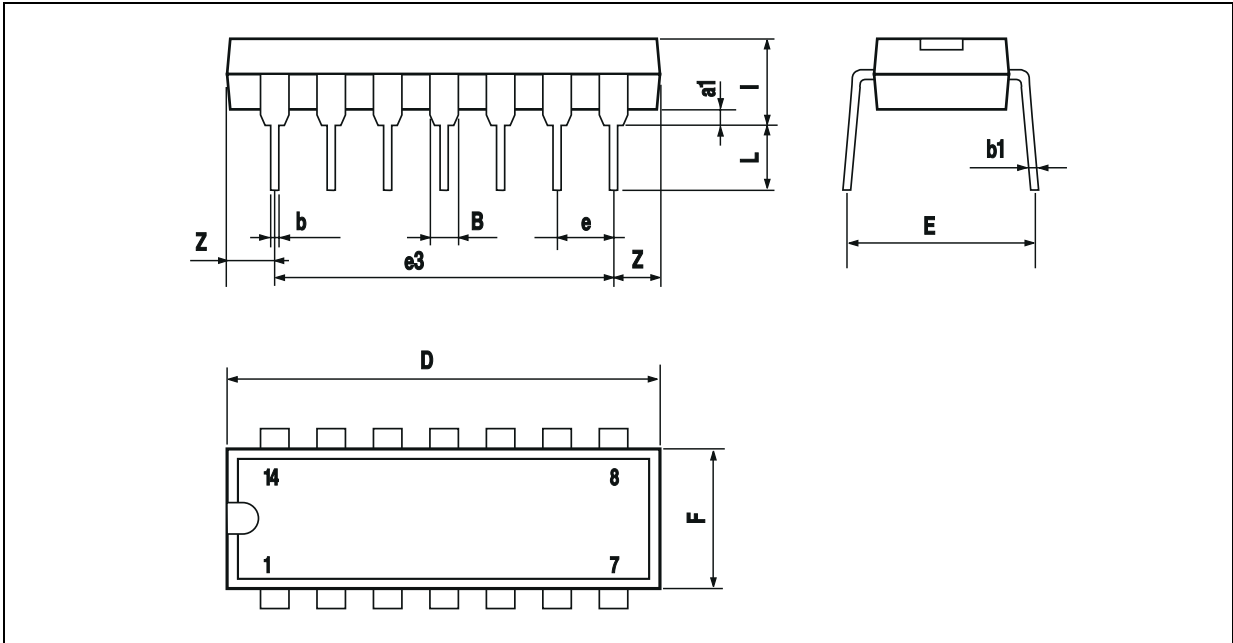

Figure 19 : High Cut filter ($G_v = 0\text{dB}$)



PACKAGE MECHANICAL DATA
 14 PINS - PLASTIC PACKAGE



Dimensions	Millimeters			Inches		
	Min.	Typ.	Max.	Min.	Typ.	Max.
a1	0.51			0.020		
B	1.39		1.65	0.055		0.065
b		0.5			0.020	
b1		0.25			0.010	
D			20			0.787
E		8.5			0.335	
e		2.54			0.100	
e3		15.24			0.600	
F			7.1			0.280
i			5.1			0.201
L		3.3			0.130	
Z	1.27		2.54	0.050		0.100

PACKAGE MECHANICAL DATA
14 PINS - PLASTIC MICROPACKAGE (SO)

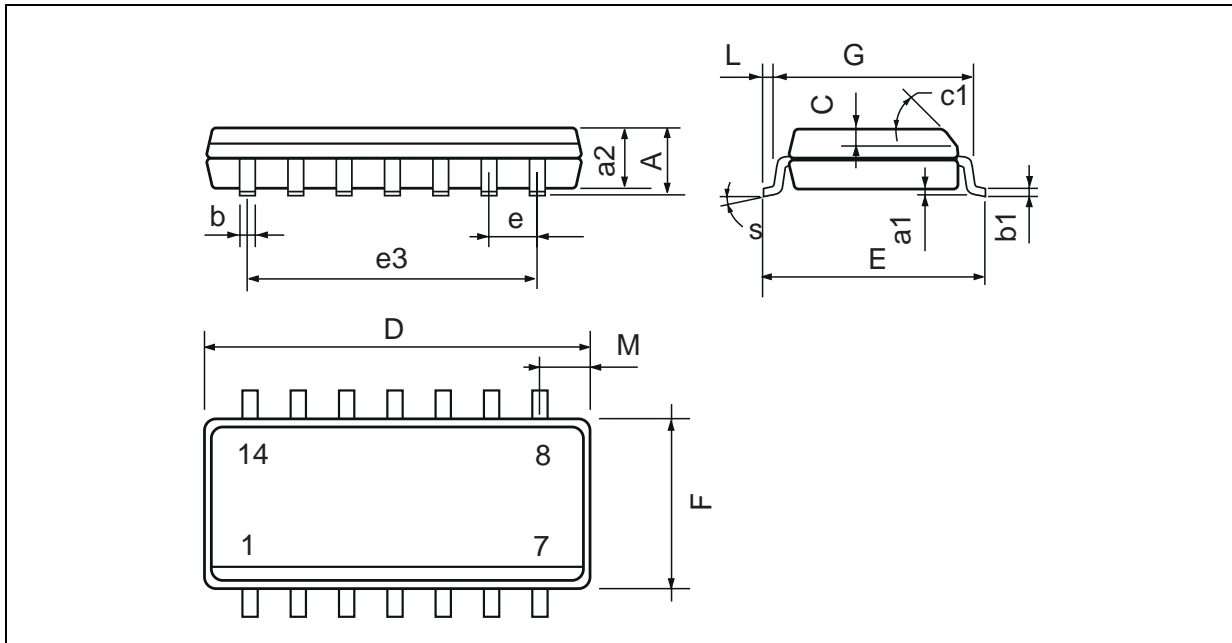

Dimensions	Millimeters			Inches		
	Min.	Typ.	Max.	Min.	Typ.	Max.
A			1.75			0.069
a1	0.1		0.2	0.004		0.008
a2			1.6			0.063
b	0.35		0.46	0.014		0.018
b1	0.19		0.25	0.007		0.010
C		0.5			0.020	
c1	45° (typ.)					
D (1)	8.55		8.75	0.336		0.344
E	5.8		6.2	0.228		0.244
e		1.27			0.050	
e3		7.62			0.300	
F (1)	3.8		4.0	0.150		0.157
G	4.6		5.3	0.181		0.208
L	0.5		1.27	0.020		0.050
M			0.68			0.027
S	8° (max.)					

Note : (1) D and F do not include mold flash or protrusions - Mold flash or protrusions shall not exceed 0.15mm (.066 inc) ONLY FOR DATA BOOK.

Information furnished is believed to be accurate and reliable. However, STMicroelectronics assumes no responsibility for the consequences of use of such information nor for any infringement of patents or other rights of third parties which may result from its use. No license is granted by implication or otherwise under any patent or patent rights of STMicroelectronics. Specifications mentioned in this publication are subject to change without notice. This publication supersedes and replaces all information previously supplied. STMicroelectronics products are not authorized for use as critical components in life support devices or systems without express written approval of STMicroelectronics.

© The ST logo is a registered trademark of STMicroelectronics

© 2001 STMicroelectronics - Printed in Italy - All Rights Reserved
STMicroelectronics GROUP OF COMPANIES

Australia - Brazil - Canada - China - Finland - France - Germany - Hong Kong - India - Israel - Italy - Japan - Malaysia
Malta - Morocco - Singapore - Spain - Sweden - Switzerland - United Kingdom - United States

© <http://www.st.com>

