

# OKI

DECEMBER 1983

semiconductor

## MSM5832 MICROPROCESSOR REAL-TIME CLOCK/CALENDAR

### GENERAL DESCRIPTION

The MSM5832 is a monolithic, metal-gate CMOS integrated circuit that functions as a real time clock/calendar for use in bus-oriented microprocessor applications. The on-chip 32,768 Hz crystal controlled oscillator time base is counted down to provide addressable 4-bit I/O data of SECONDS, MINUTES, HOURS, DAY-OF-WEEK, DATE, MONTH, and YEAR. Data access is controlled by 4-bit address, chip select, read, write and hold inputs. Other functions include 12H/24H format selection, leap year identification and manual  $\pm 30$  second correction.

The MSM5832 normally operates from a 5 volt  $\pm 5\%$  supply. Battery back-up operation down to 2.2 volts allows continuation of time keeping when main power is off. One test input facilitates rapid testing of the time keeping operations. The MSM5832 is offered in an 18-lead dual-in-line plastic (RS suffix) package.

### FEATURES

- Microprocessor bus-oriented
- TIME MONTH DATE YEAR DAY OF WEEK  
23:59:59 12 - 31 - 99 - 7
- 4-BIT DATA BUS
- 4-BIT ADDRESS
- Read, Write, Hold, Chip select inputs
- Interrupt signal outputs—1024, 1, 1/60, 1/3600 Hz
- 32,768 KHz crystal controlled operation
- Leap year register bit
- 12 or 24 hour format
- $\pm 30$  second error correction
- Single 5 volt power supply
- Back-up battery operation to VDD=2.2 V
- Low Power Dissipation  
90  $\mu$ w Max. at VDD=3 V  
2.5 mw Max. at VDD=5 V
- High Density 300 mil 18-Pin Package

### FUNCTIONAL BLOCK DIAGRAM

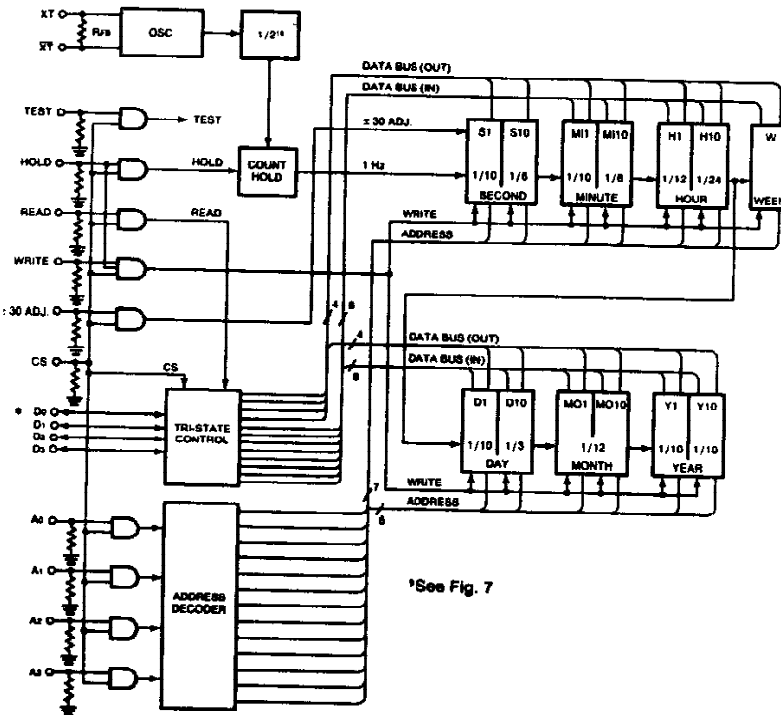

### PIN CONFIGURATION

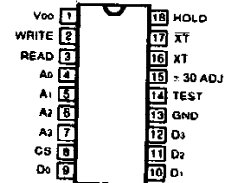

- A0 to A3: Address Inputs
- WRITE: Write Enable
- READ: Read Enable
- HOLD: Count Hold Enable
- CS: Chip Select
- D0 to D3: Data Input/Output
- TEST: Test Input
- $\pm 30$  ADJ:  $\pm 30$  Second Correction Input
- XT & XT-bar: xtal oscillator connections
- VDD: +5 V Supply
- GND: Ground

MSM5832 MICROPROCESSOR REAL-TIME CLOCK/CALENDAR

**FUNCTION TABLE**

**FIGURE 1**

ADDRESS INPUTS				INTERNAL COUNTER	DATA I/O				DATA LIMITS	NOTES
A <sub>0</sub>	A <sub>1</sub>	A <sub>2</sub>	A <sub>3</sub>		D <sub>0</sub>	D <sub>1</sub>	D <sub>2</sub>	D <sub>3</sub>		
0	0	0	0	S 1	*	*	*	*	0 ~ 9	S <sub>1</sub> or S <sub>10</sub> are reset to zero irrespective of input data D <sub>0</sub> ~D <sub>3</sub> when write instruction is executed with address selection
1	0	0	0	S 10	*	*	*	*	0 ~ 5	
0	1	0	0	MI 1	*	*	*	*	0 ~ 9	
1	1	0	0	MI 10	*	*	*	*	0 ~ 5	
0	0	1	0	H 1	*	*	*	*	0 ~ 9	
1	0	1	0	H 10	*	*	†	†	0~1 0~2	D <sub>2</sub> ="1" for PM    D <sub>3</sub> ="1" for 24 hour format D <sub>2</sub> ="0" for AM    D <sub>3</sub> ="0" for 12 hour format
0	1	1	0	W	*	*	*	*	0 ~ 6	
1	1	1	0	D 1	*	*	*	*	0 ~ 9	D <sub>2</sub> ="1" for 29 days in month 2 D <sub>2</sub> ="0" for 28 days in month 2 (2)
0	0	0	1	D 10	*	*	†	†	0 ~ 3	
1	0	0	1	MO 1	*	*	*	*	0 ~ 9	
0	1	0	1	MO 10	*	*	*	*	0 ~ 1	
1	1	0	1	Y 1	*	*	*	*	0 ~ 9	
0	0	1	1	Y 10	*	*	*	*	0 ~ 9	

- (1) \*data valid as "0" or "1"  
 blank does not exist (unrecognized during a write and held at "0" during a read)  
 †data bits used for AM/PM, 12/24 HOUR and leap year must be masked from the H10 and D10 registers for correct time to be read.
- (2) If D<sub>2</sub> previously set to "1", upon completion of month 2 day 29, D<sub>2</sub> will be internally reset to "0"

**TYPICAL CHARACTERISTICS—Oscillator Frequency Deviations**

**Frequency Deviation vs Temperature**

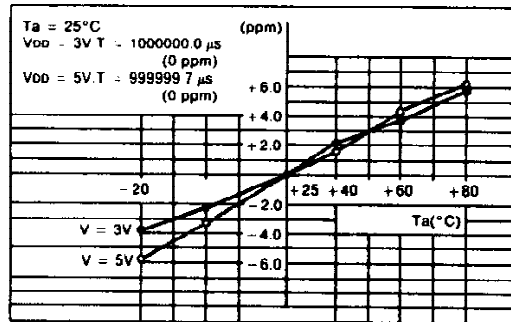

**Frequency Deviation vs Supply Voltage**

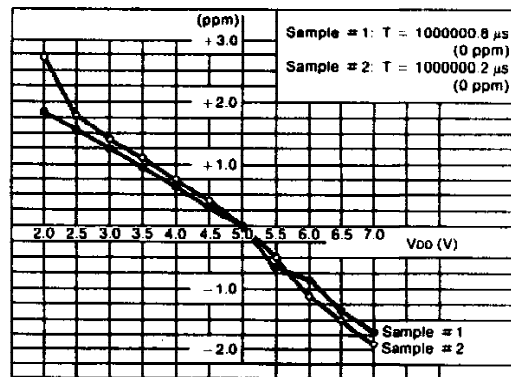

**FIGURE 2**

**FIGURE 3**

**ABSOLUTE MAXIMUM RATINGS**

Rating	Symbol	Value	Unit
Supply Voltage	V <sub>DD</sub>	-0.3 ~ 7.0	V
Input Voltage	V <sub>IN</sub>	-0.3 ~ V <sub>DD</sub> + 0.3	V
Data I/O Voltage	V <sub>D</sub>	-0.3 ~ V <sub>DD</sub> + 0.3	V
Storage Temperature	T <sub>stg</sub>	-55 ~ 150	°C

Note: Stresses above those listed under ABSOLUTE MAXIMUM RATINGS may cause permanent damage to the device. This is a stress rating only and functional operation of the device at these or at any other condition above those indicated in the operational sections of this specification is not implied. Exposure to absolute maximum rating conditions for extended periods may affect device reliability.

## OPERATING CONDITIONS

Parameter	Symbol	Min.	Typ.	Max.	Unit	Conditions
Supply Voltage	V <sub>DD</sub>	4.75	5	5.25	V	5V ± 5%
Standby Supply Voltage	V <sub>DDS</sub>	2.2	5	7	V	
Input Signal Level	V <sub>IH</sub>	3.6	5	V <sub>DD</sub>	V	V <sub>DD</sub> = 5V ± 5% Respect to Gnd
	V <sub>IL</sub>	-0.3	0	0.8	V	
Crystal Oscillator Freq.	f(XT)		32.768	65.536*	KHz	
Operating Temperature	T <sub>a</sub>	-30		+85	°C	

\*Device will run at 2× speed when operating at 65.536KHz f(XT)

## DC CHARACTERISTICS

(V<sub>DD</sub> = 5V ± 5%; T<sub>a</sub> = -30 to +85°C, unless otherwise noted)

Parameter	Symbol	Min.	Typ.	Max.	Unit	Conditions
Input Current (1)	I <sub>IH</sub>	10	25	50	μA	V <sub>IN</sub> = 5V
	I <sub>IL</sub>	-1		1	μA	V <sub>IN</sub> = 0V
Data I/O Leakage Current	I <sub>LD</sub>	-1		1	μA	V <sub>I/O</sub> = 0 to V <sub>DD</sub> , CS = "0"
Output Low Voltage	V <sub>OL</sub>			0.4	V	I <sub>O</sub> = 1.6 ma, CS = "1", READ = "1"
Output Low Current	I <sub>OL</sub>	1.6			mA	V <sub>O</sub> = 0.4V, CS = "1", READ = "1"
Output High Voltage	V <sub>OH</sub>	Open Drain n-MOS Output; Depends on value of Pull-up Resistor				See Fig. 7
Output High Current	I <sub>OH</sub>					
Operating Supply Current	I <sub>DDs</sub>			30	μA	V <sub>DD</sub> = 3V, T <sub>a</sub> = 25°C
	I <sub>DD</sub>			500	μA	V <sub>DD</sub> = 5V, T <sub>a</sub> = 25°C

(1) XT, XT and D0~D3 excluded.

## AC CHARACTERISTICS

### CAPACITANCE

T<sub>a</sub> = 25°C, f = 1 MHz

Parameter	Symbol	Min.	Typ.	Max.	Unit
Input/Output Capacitance	C <sub>I/O</sub>			8	pF
Input Capacitance	C <sub>IN</sub>			5	pF

Note: This parameter is periodically sampled and not 100% tested.

### READ CYCLE

(V<sub>DD</sub> = 5V ± 5%; T<sub>a</sub> = 25°C)

Parameter	Symbol	Min.	Typ.	Max.	Unit
HOLD Set-up Time	t <sub>HS</sub>	150			μS
HOLD Hold Time	t <sub>HH</sub>	0			μS
HOLD Pulse Width	t <sub>HW</sub>			1	SEC
READ Hold Time	t <sub>RH</sub>	0			μS
ADDRESS Access Time	t <sub>RA</sub>			6	μS
READ Access Time	t <sub>RA</sub>		.3	.6	μS

### READ CYCLE

### FIGURE 4

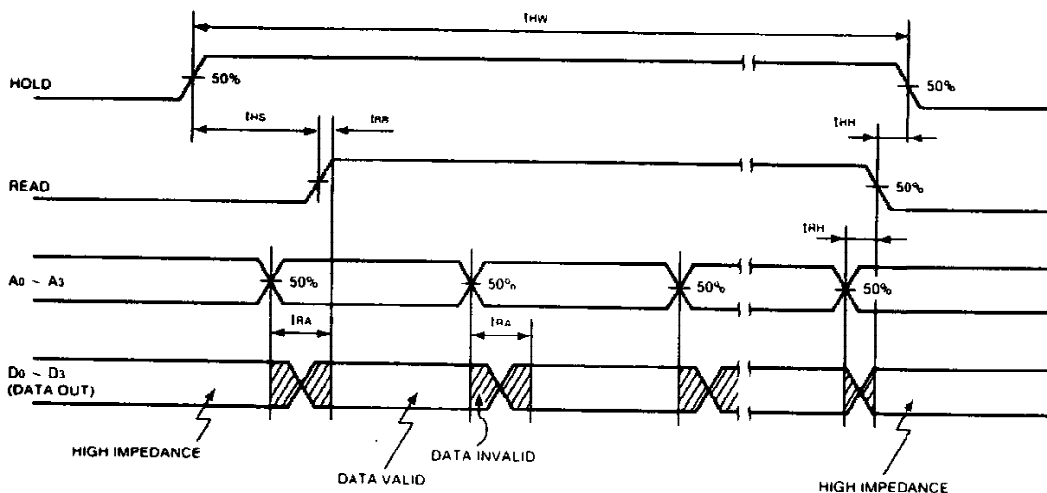

- Notes:**
1. A Read occurs during the overlap of a high CS and a high READ
  2. Output Load: 1 TTL Gate, C<sub>L</sub> = 50 pF and R<sub>L</sub> = 4.7 KΩ
  3. CS may be a permanent "1", or may be coincident with HOLD pulse

### WRITE CYCLE

(V<sub>DD</sub> = 5V ± 5%; T<sub>a</sub> = 25°C)

Parameter	Symbol	Min.	Max.	Unit
HOLD Set-up Time	t <sub>HS</sub>	150		μS
HOLD Hold Time	t <sub>HH</sub>	0		μS
HOLD Pulse Width	t <sub>HW</sub>		1	SEC
ADDRESS Pulse Width	t <sub>AW</sub>	1.7		μS
DATA Pulse Width	t <sub>DW</sub>	1.7		μS
DATA Set-up Time	t <sub>DS</sub>	0.5		μS
DATA Hold Time	t <sub>DH</sub>	0.2		μS
WRITE Pulse Width	t <sub>WW</sub>	1.0		μS

### WRITE CYCLE

### FIGURE 5

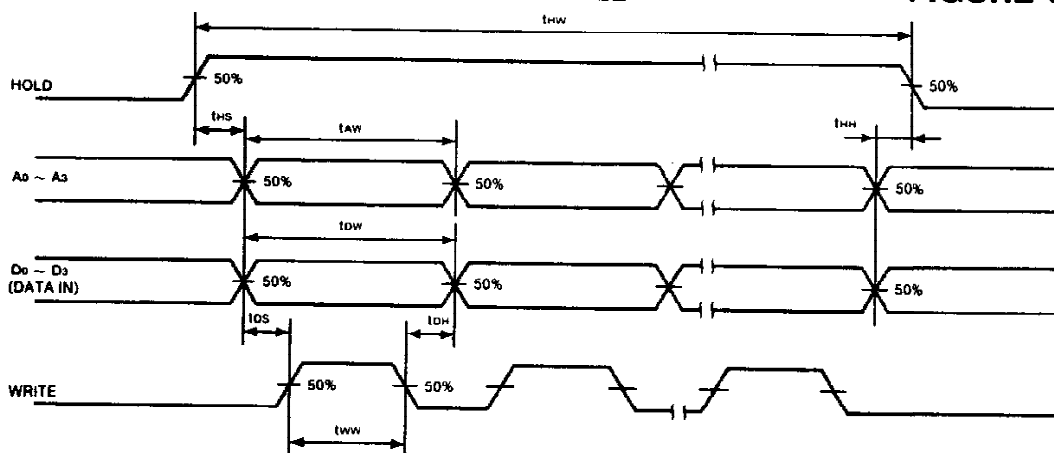

- Notes:**
1. A WRITE occurs during the overlap of a high CS, a high HOLD and a high WRITE
  2. CS may be a permanent "1", or may be coincident with HOLD pulse

## FUNCTIONAL DESCRIPTION

A block diagram of the MSM5832 microprocessor real-time clock/calendar and a package connection diagram are shown on the first page. Figure 9 illustrates a method of interfacing between the clock/calendar circuit and a micro processor. Figures 9, 10 and 11 illustrate alternative standby power supply circuits. A function table listing relationships between address inputs, data input/output and internal counter selection is shown in Figure 1. Unless otherwise indicated, the following descriptions are based on the block diagram.

**32.768 K Hz OSCILLATOR (pins 16 and 17):** An internal inverting amplifier with feedback resistor, RFB, is connected with a crystal and two capacitors as shown in Figure 6 to form a stable, accurate oscillator—which serves as the precision time base of the circuit. Capacitors C1 and C2 in series provide the parallel load capacitance required for precise tuning of the quartz crystal. Typical oscillator performance as a function of ambient temperature and supply voltage is shown in Figures 2 and 3 respectively.

### OSCILLATOR CIRCUIT

FIGURE 6

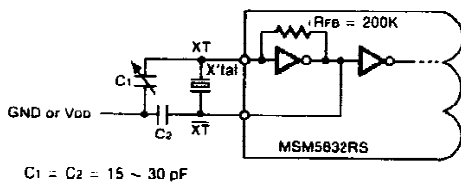

C1 = C2 = 15 ~ 30 pF

**CHIP SELECT (pin 8):** Connecting CS input to VDD enables all inputs and outputs. Unconnected—pull-down to GND is provided by an internal resistor—or connecting CS to GND will disable HOLD, WRITE, READ, ±30 ADJ, D0~D3, A0~A3 and TEST.

As shown in Figure 9 CS can be used to detect system power failure by connecting system power (+5V) to CS, so that when system power is on, all inputs and outputs will be enabled, and when system power is off, all inputs and outputs will be disabled. The threshold voltage of CS is higher than all other inputs to insure correct operation of this function.

**HOLD (pin 18):** Switching this input to VCC inhibits the internal 1Hz clock to the S1 counter. After the specified HOLD set-up time (150 μs), all counters will be in a static state, thus allowing error-free read or write operations. So long as the HOLD pulse width is less than 1 second, accuracy of the real time will be undisturbed. Pull-down to GND is provided by an internal resistor.

**READ (pin 3):** Read function as shown in Figure 4 is enabled when READ is switched to VDD. Pull-down to GND is provided by an internal resistor.

**WRITE (pin 2):** Write function as shown in Figure 5 is enabled when WRITE is switched to VDD. Pull-down to GND is provided by an internal resistor.

**±30 ADJ (Pin 15):** Momentarily connecting this input to VCC (>31.25 ms) will reset seconds (S1, S10 counters and 2<sup>11</sup>~2<sup>13</sup> frequency dividers) to 00; if seconds were 30 or more, one minute is added to the minutes (M1 counter) and if seconds were less than 30, the minutes are unchanged. Pull-down to GND is provided by an internal resistor.

**A0 ~ A3 (pins 4 ~ 7):** Address inputs, used to select internal counters for read/write operations (see function table—Figure 1). A "1" is defined as VDD; a "0" is GND. Pull-down to GND is provided by internal resistors.

**D0 ~ D3 (pins 9 ~ 12):** Data Inputs/Outputs, two-way bus lines controlled by READ and WRITE inputs. As shown in Figure 7 external pull-up resistors of 4.7K or higher are required by the open-drain N-channel MOS outputs. D3 is the MSB, D0 is the LSB.

**TEST (pin 14):** Normally this input is unconnected—pull-down to GND is provided by an internal resistor—or connected to GND. With CS at VDD, pulses to VDD on the TEST input will directly clock the S1, M10, W, D1 and Y1 counters, depending on which counter is addressed (W and D1 are selected by D1 address in this mode only). Roll-over to next counter is enabled in this mode.

Max. Input Freq = 10KHz

### DATA I/O CIRCUIT

FIGURE 7

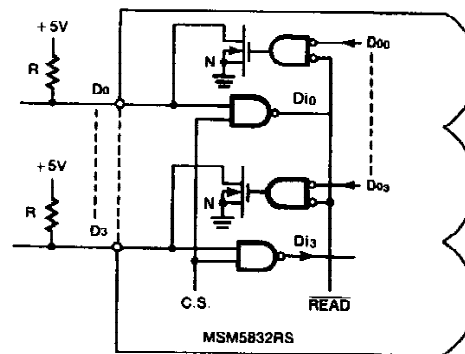

### REFERENCE SIGNAL OUTPUT

Reference signals are available as outputs on D0 ~ D3 if CS, READ and A0 ~ A3 are at VDD. Refer to Figure 8 for specifics. As shown in Figure 9 these signals may be used to generate interrupts for the microprocessor.

### REFERENCE SIGNAL OUTPUTS

FIGURE 8

CONDITIONS	OUTPUT	REFERENCE FREQUENCY	PULSE WIDTH
HOLD = L	D0 (1)	1024 Hz	duty 50 %
READ = H	D1 (2)	1 Hz	122.1 μs
C.S. = H	D2 (2)	1/60 Hz	122.1 μs
A0 ~ A3 = H	D3 (3)	1/3600 Hz	122.1 μs

- 1) 1024 Hz signal at D0 not dependent on HOLD input level. Use this signal for trimming the quartz oscillator. Probe capacitance will load the oscillator if a probe is placed on XT or XT causing erroneous readings. Trim to 976.5625 μs ± .0015 μs
- 2) Negative Pulse, Negative True
- 3) Positive Pulse, Positive True



This datasheet has been download from:

[www.datasheetcatalog.com](http://www.datasheetcatalog.com)

Datasheets for electronics components.