

Low-voltage digital IF receiver

SA637

DESCRIPTION

The SA637 is a low-voltage high performance monolithic digital system with high-speed RSSI incorporating a mixer, oscillator with buffered output, two limiting intermediate frequency amplifiers, fast logarithmic received signal strength indicator (RSSI), voltage regulator, RSSI op amp and power down pin. The SA637 is available in SSOP (shrink small outline package).

The SA637 was designed for portable digital communication applications and will function down to 2.7V. The limiter amplifier has differential outputs with 2MHz small signal bandwidth. The RSSI output has access to the feedback pin. This enables the designer to level adjust the outputs or add filtering.

FEATURES

- $V_{CC} = 2.7$ to $5.5V$
- Low power receiver ($3.8mA @ 3V$)
- Power down mode ($I_{CC} = 110\mu A$)
- Fast RSSI rise and fall times
- Extended RSSI range with temperature compensation
- RSSI op amp
- 2MHz limiter small signal bandwidth
- 455kHz filter matching ($1.5k\Omega$)
- Differential limiter output
- Oscillator buffer
- SSOP-20 package

APPLICATIONS

- ADC (American Digital Cellular)
- Digital receiver systems
- Cellular radio

PIN CONFIGURATION

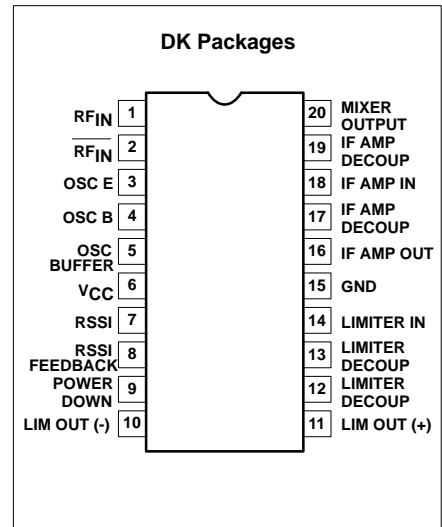

ORDERING INFORMATION

DESCRIPTION	TEMPERATURE RANGE	ORDER CODE	DWG #
20-Pin Plastic Shrink Small Outline Package (Surface-mount)	-40 to +85°C	SA637DK	1563

BLOCK DIAGRAM

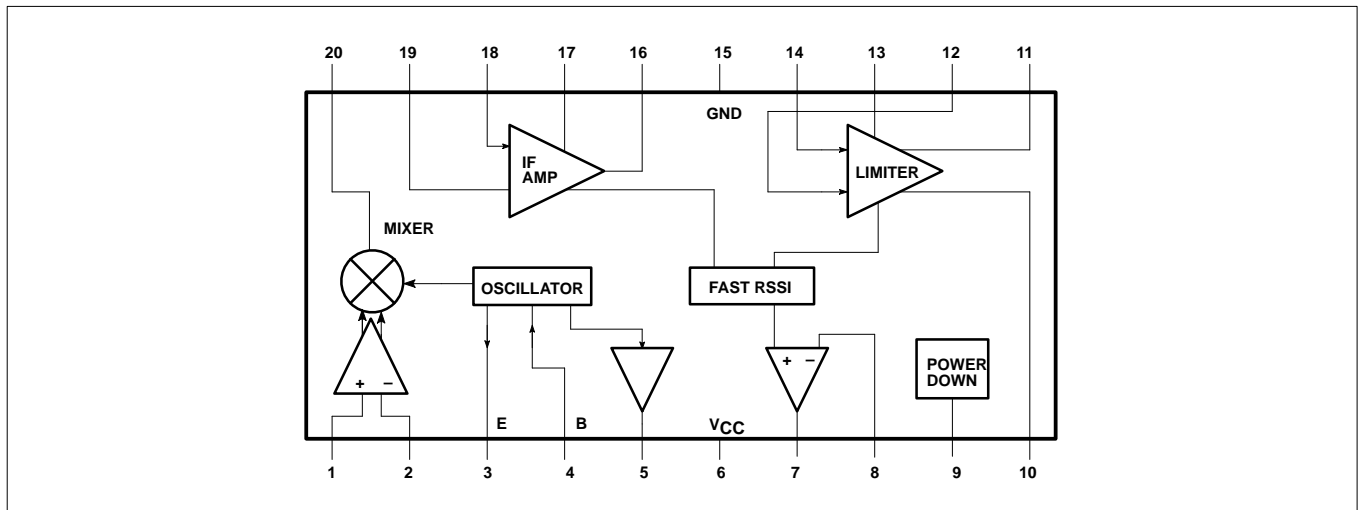

Low-voltage digital IF receiver

SA637

ABSOLUTE MAXIMUM RATINGS

SYMBOL	PARAMETER	RATING	UNITS
V_{CC}	Supply voltage	-0.3 to +6.0	V
V_{IN}	Voltage applied to any other pin	-0.3 to ($V_{CC} + 0.3$)	V
T_{STG}	Storage temperature range	-65 to +150	°C
T_A	Operating ambient temperature range	-40 to +85	°C

NOTE: Thermal impedance (θ_{JA}) = 117°C/W

DC ELECTRICAL CHARACTERISTICS

 $V_{CC} = +3V$, $T_A = 25^\circ C$; unless otherwise stated.

SYMBOL	PARAMETER	TEST CONDITIONS	LIMITS			UNITS
			MIN	TYP	MAX	
V_{CC}	Power supply voltage range		2.7		5.5	V
I_{CC}	DC current drain	Pin 9 = HIGH or OPEN		3.8	4.5	mA
		$V_{CC} = 4.7V$		4.4	5.5	mA
	Standby	Pin 9 = LOW		0.11	0.5	mA
	Input current	Pin 9 = LOW	-10		10	μA
		Pin 9 = HIGH	-10		10	μA
	Input level	Pin 9 = LOW	0		$0.3V_{CC}$	μA
		Pin 9 = HIGH	$0.7V_{CC}$		V_{CC}	μA
t_{ON}	Power up time	RSSI valid (10% to 90%)		10		μs
t_{OFF}	Power down time	RSSI invalid (90% to 10%)		5		μs

AC ELECTRICAL CHARACTERISTICS

$T_A = 25^\circ C$; $V_{CC} = +3V$, unless otherwise stated. RF frequency = 90MHz; RF input step-up = +14.5dBV; IF frequency = 455kHz; RF level = -68dBm. Test circuit Figure 1. The parameters listed below are tested using automatic test equipment to assure consistent electrical characteristics. The limits do not represent the ultimate performance limits of the device. Use of an optimized RF layout will improve many of the listed parameters.

SYMBOL	PARAMETER	TEST CONDITIONS	LIMITS			UNITS
			MIN	TYP	MAX	
Mixer/Osc section						
f_{IN}	Input signal frequency			200		MHz
f_{OSC}	Crystal oscillator frequency			200		MHz
NF	Noise figure at 90MHz	Matched input and output		6.2		dB
TOI	Third-order input intercept point	Input matched to 50 Ω source		-17		dBm
P1dB	Input 1dB compression point			-27		dBm
	Conversion power gain	Matched 50 Ω		7		dB
R_{IN}	Mixer input resistance			2.5		k Ω
C_{IN}	Mixer input capacitance			2.2		pF
R_{OUT}	Mixer output resistance			1.87		k Ω
	Buffered LO output level	LO = 447mV _{P-P} , 1k Ω AC load	100	300	500	mV _{P-P}
IF section						
	IF amp power gain	50 Ω source		36		dB
	Limiter power gain	50 Ω source		60		dB
IF_{BW}	IF amp bandwidth			2.5		MHz

Low-voltage digital IF receiver

SA637

AC ELECTRICAL CHARACTERISTICS (Continued)

SYMBOL	PARAMETER	TEST CONDITIONS	LIMITS			UNITS
			MIN	TYP	MAX	
	RF RSSI output	RF level = -118dBm	.01	0.2	.65	V
		RF level = -68dBm	.4	0.9	1.7	V
		RF level = -28dBm	1.0	1.7	2.3	V
	RSSI range			90		dB
	RSSI accuracy			±1.5		dB
	RSSI ripple			30		mV _{P-P}
	RSSI speed Rise time	No interstage filter		2.5		μs
		With interstage filter		22		μs
	RSSI speed Fall time	No interstage filter		10		μs
		With interstage filter		50		μs
	IF input impedance			1.5		kΩ
	IF output impedance			1.5		kΩ
	Limiter input impedance			1.5		kΩ
	Limiter output impedance	(Pin 10, Pin 11)		200		Ω
	Limiter output signal level	(Pin 10, Pin 11) 1.5kΩ AC load		280		mV _{P-P}
	Limiter output DC level			1.27		V
	Differential output matching			±6		mV
	Differential output offset			±30		mV

CIRCUIT DESCRIPTION**Mixer**

The mixer has a balanced input and is capable of being driven single-ended. The input impedance is 2.5kΩ in parallel with a 2.2pF cap at 90MHz RF. The mixer output can drive a 1500Ω ceramic filter at 455kHz or 600kHz directly without any matching required. The mixer conversion power gain is 7dB when both input and output are matched and optimum LO level is used to drive the internal mixer core.

Oscillator and Buffer

The on-board oscillator supplies the signal for the mixer down-conversion. The internally biased transistor can be configured as a Colpitts or Butler overtone crystal oscillator. The transistor's bias current can be increased if desired by adding a shunt resistor from Pin 3 to ground. The oscillator's buffered output (Pin 5) can be used as a feedback signal to lock the oscillator to an appropriate reference.

IF Amplifier and IF Limiter

The IF strip provides more than 95dB of power gain for the down converted signal. Its

overall bandwidth is limited to 2MHz. The input and output impedance of the IF amplifier and the input impedance of the IF limiter are set to 1500Ω (match to 455kHz filter). A second filter is connected between the IF amplifier and the limiter for improved channel selectivity and reduced instability. This ceramic filter provides 3dB interstage insertion loss which results in optimal RSSI linearity. The overall gain can be reduced if desired by adding an external attenuator after the IF amplifier. The differential limiter outputs (Pins 10 and 11) are available for demodulator circuits.

RSSI

The received signal strength indicator provides a linear voltage indication of the received signal strength in dB for a range in excess of 90dB. The response time to a change in input signal is less than a few microseconds and the delay is kept to a minimum because of the use of a minimum phase shift circuit. Because of the speed of the RSSI circuit, the RSSI rise and fall time may, in practice, be dominated by the

bandwidth of the external bandpass filter that is placed between the mixer and the IF, and the external filter placed between the IF amplifier and limiter. Since the RSSI function requires the signal to propagate through the whole IF strip, and the rise and fall time of the filters are inversely proportional to their bandwidth, there is a trade-off between channel selectivity and RSSI response. A possible solution is to use a second SA637 with wider band external filters for faster RSSI response.

The RSSI curve is temperature compensated and in addition is designed for improved consistency from unit to unit.

The RSSI circuit drives an on-chip low power op amp with rail-to-rail output which can be connected as a unity gain RSSI buffer or a gain stage or even a comparator.

DC Power Supply

The IC is designed for operation between 2.7 and 5.5V. A power supply dependent biasing scheme is used in the mixers to benefit from the large headroom available at higher V_{CCS}.

Low-voltage digital IF receiver

SA637

PERFORMANCE CHARACTERISTICS

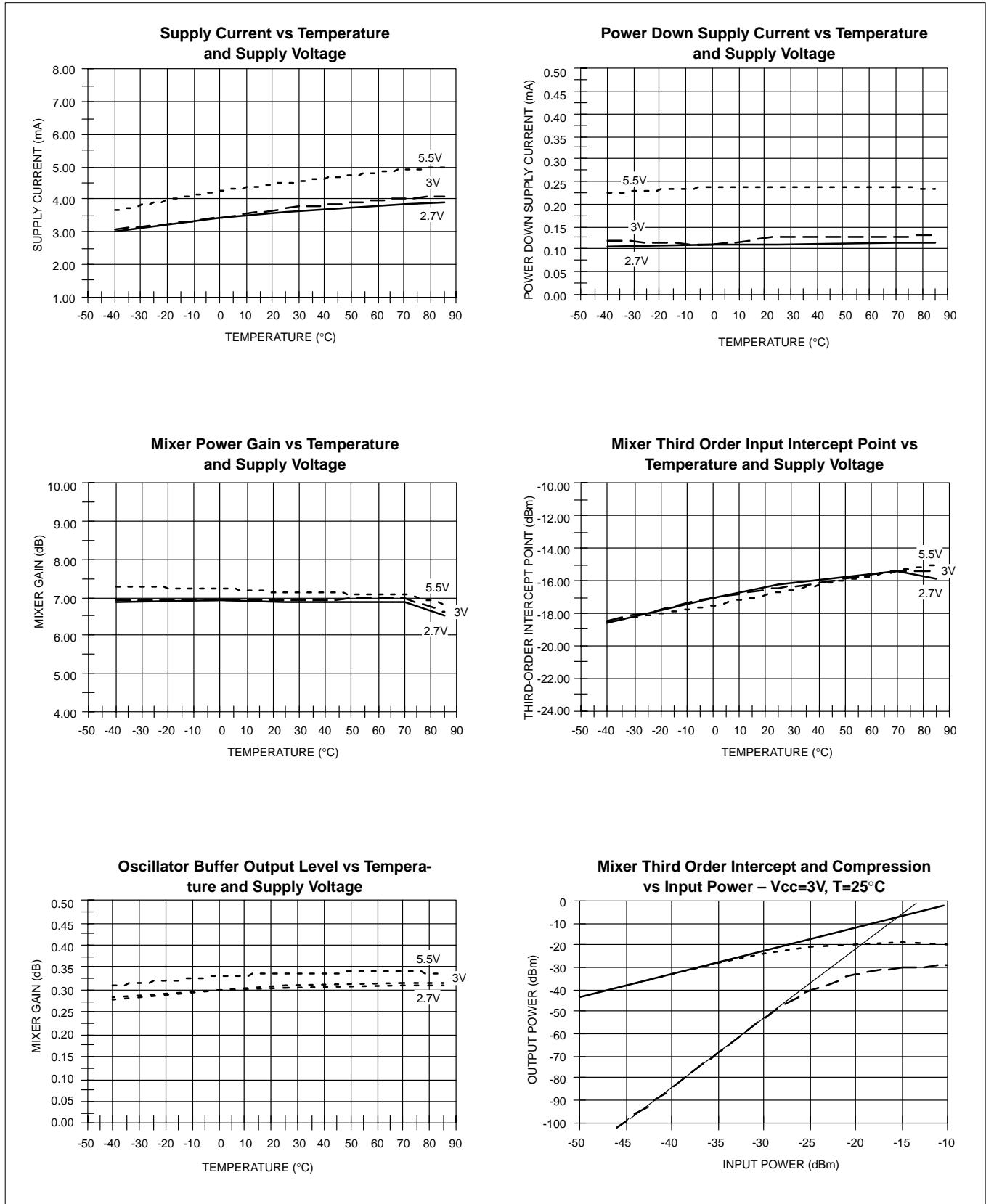

Low-voltage digital IF receiver

SA637

PERFORMANCE CHARACTERISTICS (cont.)

IF Power Gain vs Temperature and Supply Voltage

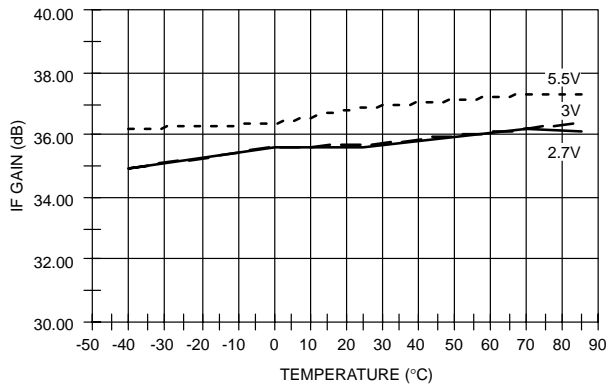

Limiter Power Gain vs Temperature and Supply Voltage

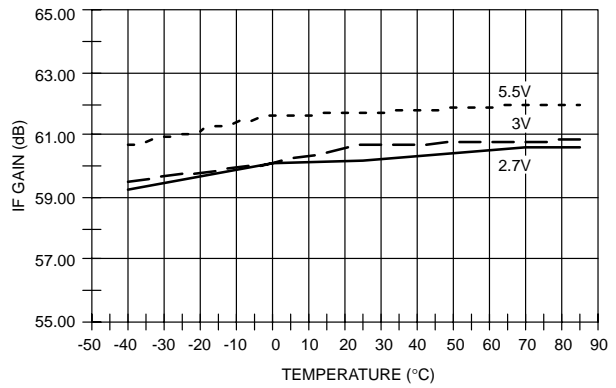

Limiter Output (+) Level vs Temperature and Supply Voltage

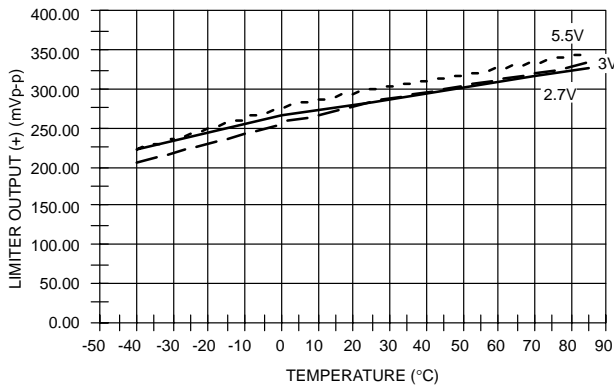

Limiter Output (-) Level vs Temperature and Supply Voltage

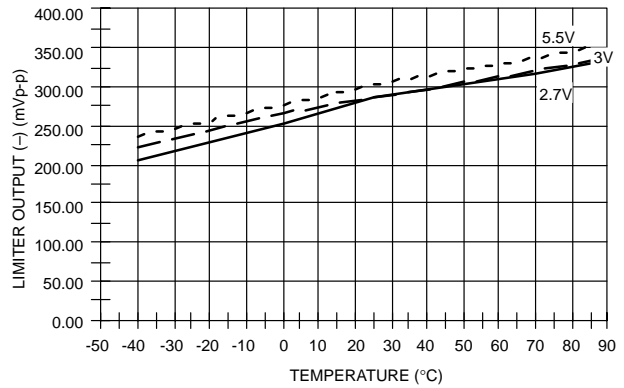

RSSI vs RF Level and Temperature – V_{CC} = 3V

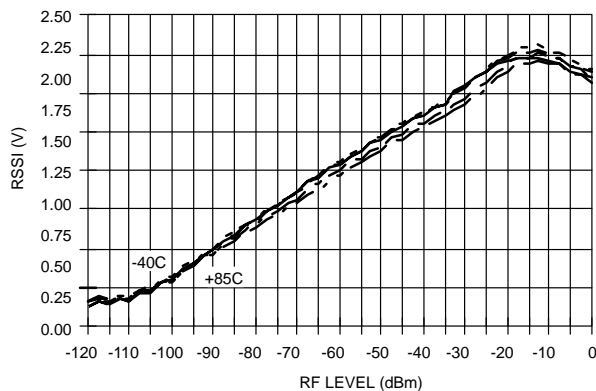

RSSI vs RF Level and Supply Voltage – Temperature = 25°C

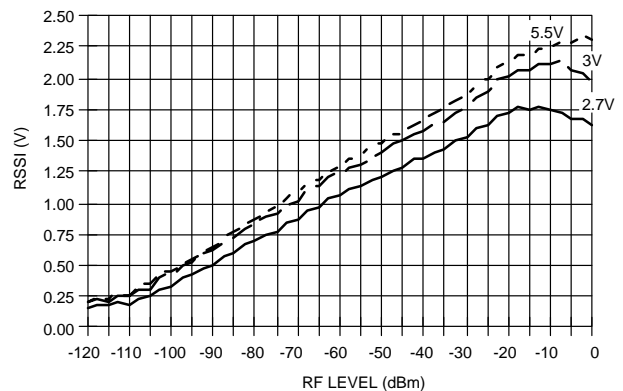

Low-voltage digital IF receiver

SA637

PIN FUNCTIONS

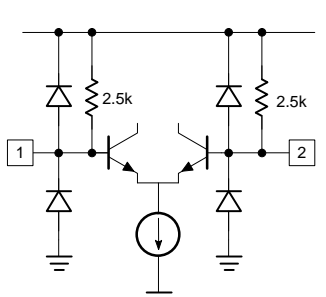
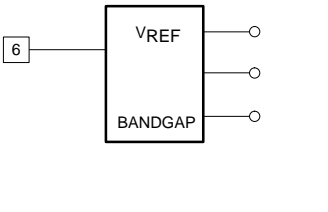
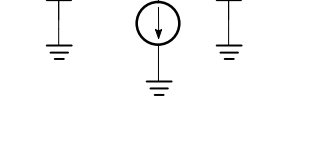
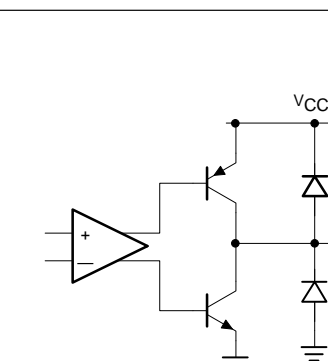
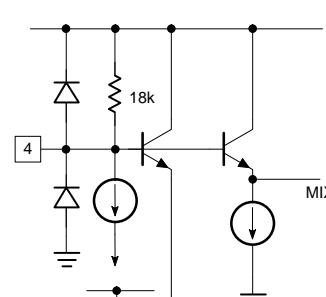
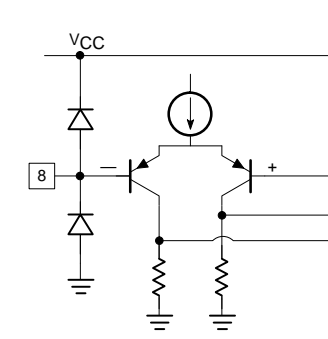
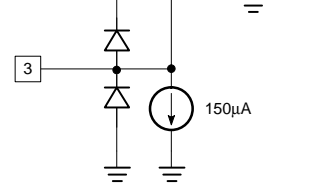
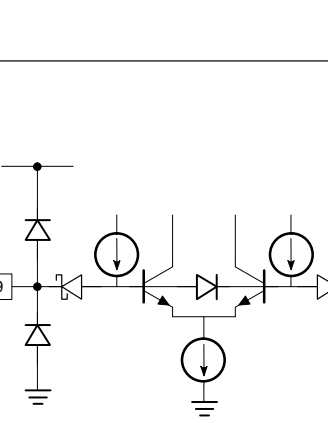
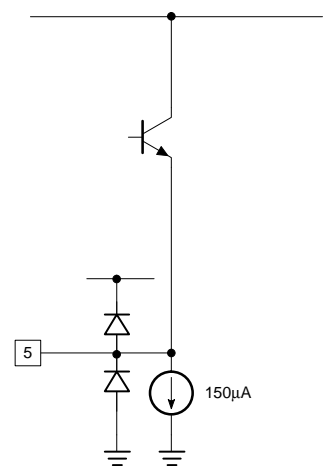
PIN No.	PIN MNEMONIC	DC V	EQUIVALENT CIRCUIT	PIN No.	PIN MNEMONIC	DC V	EQUIVALENT CIRCUIT
1	RF IN	+1.40		6	V _{CC}	+3.00	
2	RF BYPASS	+1.40		7	RSSI OUT	+0.20	
3	OSC E	+1.79		8	RSSI FEEDBACK	+0.20	
4	OSC B	+2.56		9	POWER DOWN	+2.00	
5	OSC BUFFER	+1.79					

Low-voltage digital IF receiver

SA637

PIN FUNCTIONS (continued)

PIN No.	PIN MNEMONIC	DC V	EQUIVALENT CIRCUIT	PIN No.	PIN MNEMONIC	DC V	EQUIVALENT CIRCUIT
10 11	LIMITER OUT	+1.25		16	IF AMP OUT	+1.28	
12	LIMITER DECOUP	+1.28		17	IF AMP DECOUP	+1.28	
13	LIMITER COUPLING	+1.28		18	IF AMP IN	+1.28	
14	LIMITER IN	+1.28		19	IF AMP DECOUP	+1.28	
15	GND	0		20	MIXER OUT	+2.03	

Low-voltage digital IF receiver

SA637

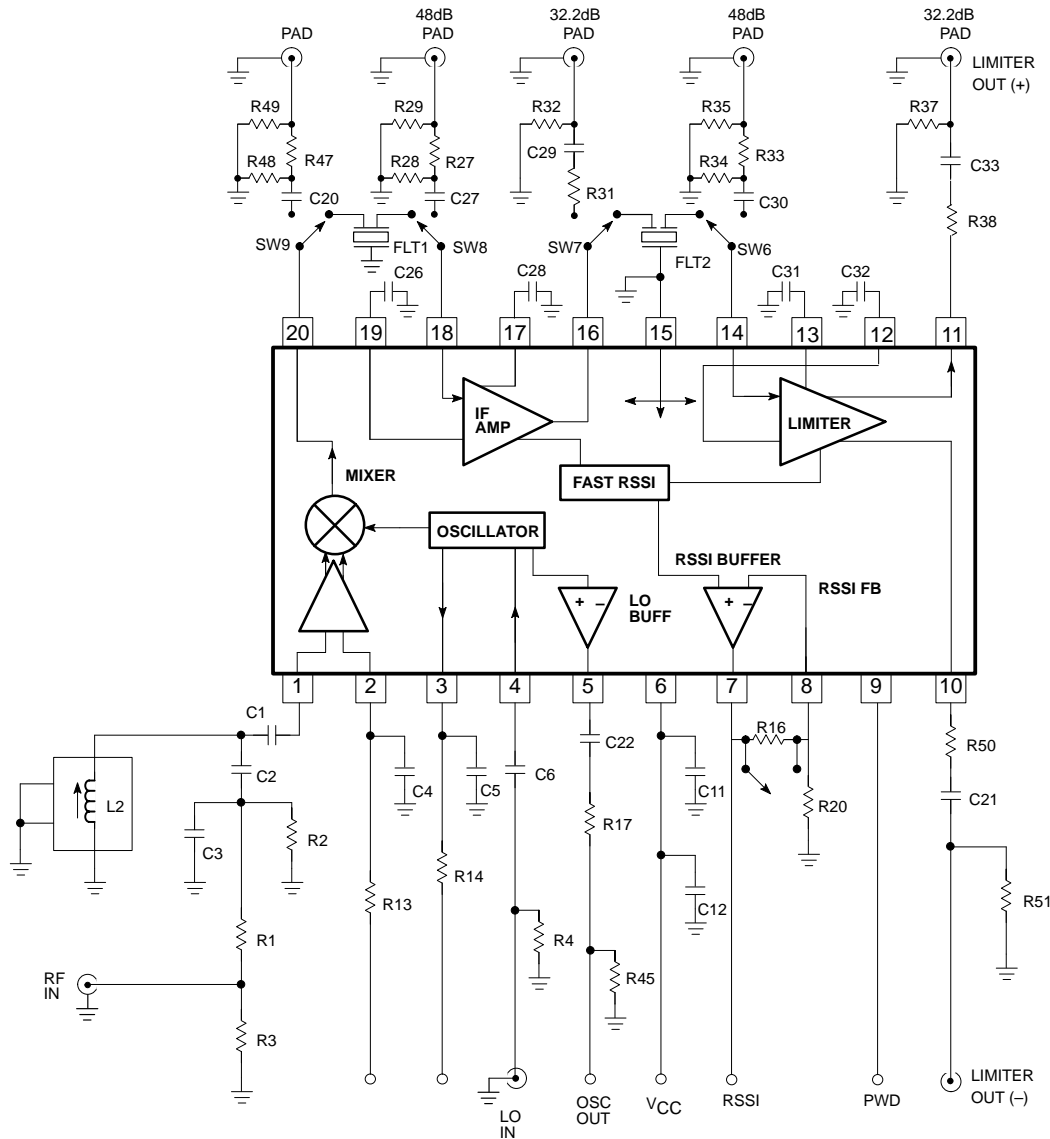

Automatic Test Circuit Component List

C1 10nF	C27 100nF	R4 49.9Ω	R32 49.9Ω	R32 49.9Ω
C2 91pF	C28 100nF	R13 10kΩ	R33 13.7kΩ	R50 1kΩ
C3 620pF	C29 100nF	R14 10kΩ	R34 1.68kΩ	R51 49.9Ω
C4 100nF	C30 100nF	R16 10kΩ	R35 49.9Ω	L2 62nH
C5 100nF	C31 100nF	R17 1kΩ	R38 1kΩ	
C6 10nF	C32 100nF	R20 10kΩ	R39 49.9Ω	
C11 100nF	C33 100nF	R27 13.7kΩ	R45 49.9Ω	
C20 100nF	R1 249Ω	R28 1.68kΩ	R47 2.43kΩ	
C21 100nF	R2 60.4Ω	R29 49.9Ω	R48 39.2kΩ	
C26 100nF	R3 60.4Ω	R31 1kΩ	R49 49.9Ω	

Figure 1. SA637 Automatic Test Circuit

Low-voltage digital IF receiver

SA637

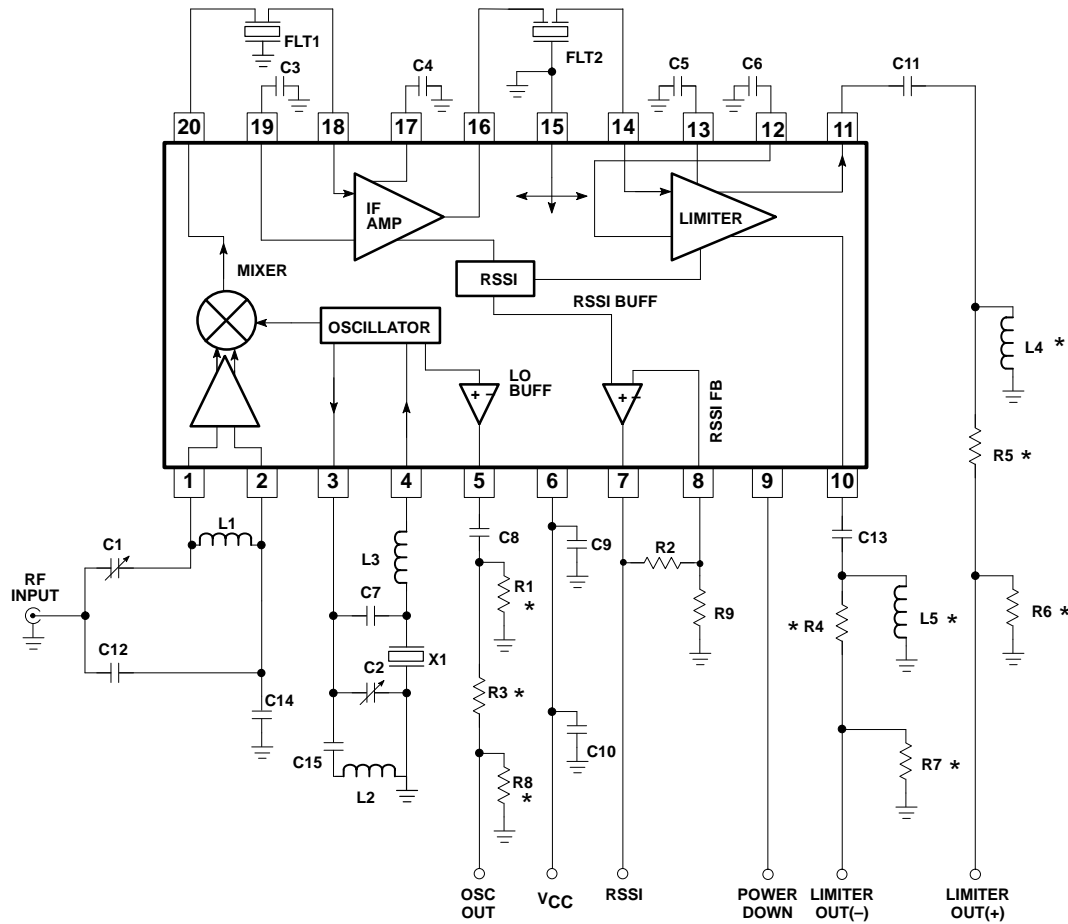

Component List

C1 5-30pF	C9 0.1μF	R1 OPEN	L1 0.15μH PM20-R15M
C2 5-30pF	C10 1.0μF	R2 0Ω (short)	L2 0.15μH PM20-R15M
C3 0.1μF	C11 0.1μF	R3 1kΩ	L3 0.47μH PM20-R47M
C4 0.1μF	C12 68pF	R4 1.0kΩ	L4 OPEN
C5 0.1μF	C13 0.1μF	R5 2.0kΩ	L5 OPEN
C6 0.1μF	C14 0.1μF	R6 51Ω	FLT1 455kHz SFGCC 455BX-TC
C7 10pF	C15 1000pF	R7 100Ω	FLT2 455kHz SFGCC 455BX-TC
C8 0.1μF		R8 100Ω	X1 82.705MHz CTS XTAL 020-3249-042
		R9 OPEN	

* NOTE: These components are optional and depend on user matching requirements. Pads are provided on the demo board. R2 and R9 set the RSSI buffer gain. For unity gain short R2 (Pin 7 to Pin 8) and leave R9 open.

Figure 2. SA637 Application Circuit

Low-voltage digital IF receiver

SA637

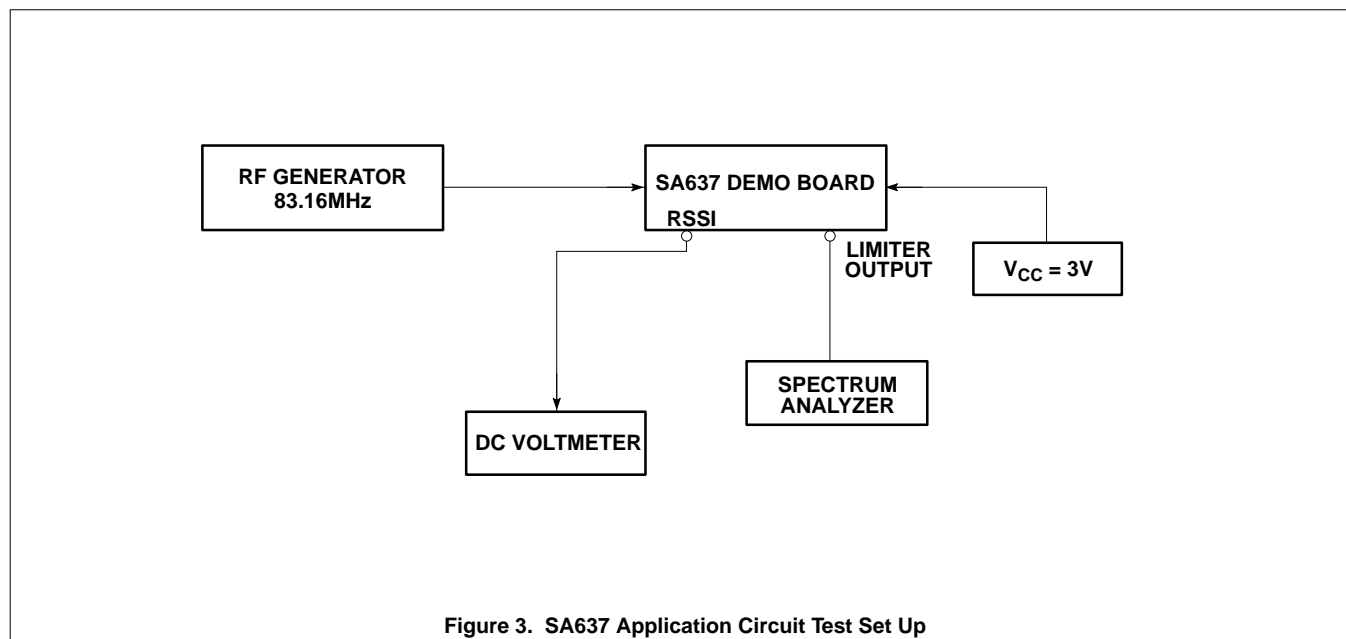

Figure 3. SA637 Application Circuit Test Set Up

NOTES:

1. Carrier-to-Noise (C/N): Connect a spectrum analyzer to Pin 10 or 11; set your RF generator to 83.16MHz or 455kHz above your LO frequency, modulation off; set the spectrum analyzer resolution bandwidth to 300Hz; and adjust your RF input level until the C/N = 26dB. Use video averaging. Assure that LIMOUT(+) and LIMOUT(-) are matched symmetrically.
2. Ceramic filters: The ceramic filter can be SFGCC455BX-TC made by Murata which has 30kHz IF bandwidth.
3. Sensitivity: The measured typical sensitivity for 12dB SINAD should be 0.45 μ V or -114dBm at the RF input.
4. Layout: The layout is very critical in the performance of the receiver. We highly recommend our demo board layout.
5. RSSI: The smallest RSSI voltage (i.e., when no RF input is present and the input is terminated) is a measure of the quality of the layout and design. If the lowest RSSI voltage is 500mV or higher, it means the receiver is in regenerative mode. In that case, the receiver sensitivity will be worse than expected.
6. Supply bypass and shielding: All of the inductors, the quad tank, and their shield must be grounded. A 0.1 μ F bypass capacitor on the supply pin improves sensitivity.

Low-voltage digital IF receiver

SA637

