



Dual N-Channel 30-V (D-S) MOSFET with Schottky Diode

PRODUCT SUMMARY		
V _{DS} (V)	r _{DS(on)} (Ω)	I _D (A)
30	0.022 @ V _{GS} = 10 V	7.5
	0.030 @ V _{GS} = 4.5 V	6.5

SCHOTTKY PRODUCT SUMMARY		
V _{DS} (V)	V _{SD} (V) Diode Forward Voltage	I _F (A)
30	0.50 V @ 1.0 A	2.0

LITTLE FOOT PLUS™

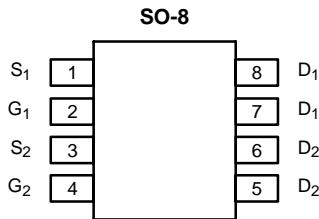

Top View

Ordering Information: Si4834DY
Si4834DY-T1 (with Tape and Reel)

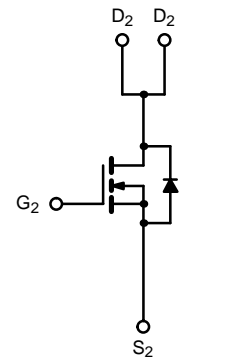
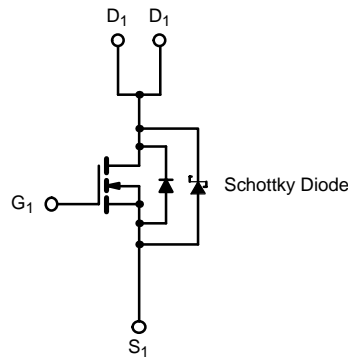

ABSOLUTE MAXIMUM RATINGS (T _A = 25 °C UNLESS OTHERWISE NOTED)					
Parameter		Symbol	10 secs	Steady State	Unit
Drain-Source Voltage		V _{DS}	30		V
Gate-Source Voltage		V _{GS}	± 20		
Continuous Drain Current (T _J = 150 °C) ^a	T _A = 25 °C	I _D	7.5	5.7	A
	T _A = 70 °C		6.0	4.6	
Pulsed Drain Current		I _{DM}	30		
Continuous Source Current (Diode Conduction) ^a		I _S	1.7	0.9	W
Maximum Power Dissipation ^a	T _A = 25 °C	P _D	2.0	1.1	
	T _A = 70 °C		1.3	0.7	
Operating Junction and Storage Temperature Range		T _J , T _{stg}	-55 to 150		°C

THERMAL RESISTANCE RATINGS							
Parameter		Symbol	MOSFET		Schottky		Unit
			Typ	Max	Typ	Max	
Maximum Junction-to-Ambient ^a	t ≤ 10 sec	R _{thJA}	52	62.5	53	62.5	°C/W
	Steady-State		93	110	93	110	
Maximum Junction-to-Foot (Drain)		R _{thJC}	35	40	35	40	

Notes

a. Surface Mounted on 1" x 1" FR4 Board.

MOSFET SPECIFICATIONS ($T_J = 25^\circ\text{C}$ UNLESS OTHERWISE NOTED).							
Parameter	Symbol	Test Condition	Min	Typ ^a	Max	Unit	
Static							
Gate Threshold Voltage	$V_{GS(th)}$	$V_{DS} = V_{GS}, I_D = 250 \mu\text{A}$	0.8			V	
Gate-Body Leakage	I_{GSS}	$V_{DS} = 0 \text{ V}, V_{GS} = \pm 20 \text{ V}$			± 100	nA	
Zero Gate Voltage Drain Current	I_{DSS}	$V_{DS} = 24 \text{ V}, V_{GS} = 0 \text{ V}$	Ch-1		100	μA	
			Ch-2		1		
		$V_{DS} = 24 \text{ V}, V_{GS} = 0 \text{ V}, T_J = 85^\circ\text{C}$	Ch-1		2000		
			Ch-2		15		
On-State Drain Current ^b	$I_{D(on)}$	$V_{DS} = 5 \text{ V}, V_{GS} = 10 \text{ V}$	20			A	
Drain-Source On-State Resistance ^b	$r_{DS(on)}$	$V_{GS} = 10 \text{ V}, I_D = 7.5 \text{ A}$		0.018	0.022	Ω	
		$V_{GS} = 4.5 \text{ V}, I_D = 6.5 \text{ A}$		0.024	0.030		
Forward Transconductance ^b	g_{fs}	$V_{DS} = 15 \text{ V}, I_D = 7.5 \text{ A}$		22		S	
Diode Forward Voltage ^b	V_{SD}	$I_S = 1 \text{ A}, V_{GS} = 0 \text{ V}$	Ch-1		0.47	0.5	V
			Ch-2		0.8	1.2	
Dynamic^a							
Total Gate Charge	Q_g	$V_{DS} = 15 \text{ V}, V_{GS} = 10 \text{ V}, I_D = 7.5 \text{ A}$		13	20	nC	
Gate-Source Charge	Q_{gs}			2			
Gate-Drain Charge	Q_{gd}			2.7			
Gate Resistance	R_g		0.5	1.9	3.2	Ω	
Turn-On Delay Time	$t_{d(on)}$	$V_{DD} = 15 \text{ V}, R_L = 15 \Omega$ $I_D \cong 1 \text{ A}, V_{GEN} = 10 \text{ V}, R_G = 6 \Omega$		8	16	ns	
Rise Time	t_r			10	20		
Turn-Off Delay Time	$t_{d(off)}$			21	40		
Fall Time	t_f			10	20		
Source-Drain Reverse Recovery Time	t_{rr}	$I_F = 1.7 \text{ A}, di/dt = 100 \text{ A}/\mu\text{s}$	Ch-1		32	70	
			Ch-2		40	80	

Notes

- a. Guaranteed by design, not subject to production testing.
 b. Pulse test; pulse width $\leq 300 \mu\text{s}$, duty cycle $\leq 2\%$.

SCHOTTKY SPECIFICATIONS ($T_J = 25^\circ\text{C}$ UNLESS OTHERWISE NOTED)						
Parameter	Symbol	Test Condition	Min	Typ	Max	Unit
Forward Voltage Drop	V_F	$I_F = 1.0 \text{ A}$		0.47	0.50	V
		$I_F = 1.0 \text{ A}, T_J = 125^\circ\text{C}$		0.36	0.42	
Maximum Reverse Leakage Current	I_{rm}	$V_r = 30 \text{ V}$		0.004	0.100	mA
		$V_r = 30 \text{ V}, T_J = 100^\circ\text{C}$		0.7	10	
		$V_r = -30 \text{ V}, T_J = 125^\circ\text{C}$		3.0	20	
Junction Capacitance	C_T	$V_r = 10 \text{ V}$		50		pF



TYPICAL CHARACTERISTICS (25°C UNLESS NOTED)

MOSFET

Output Characteristics

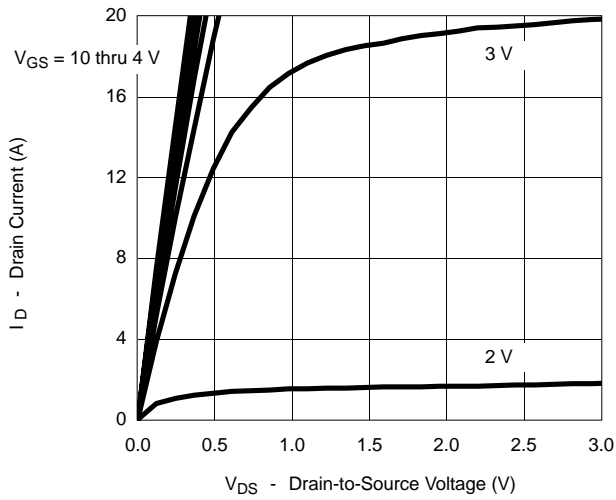

Transfer Characteristics

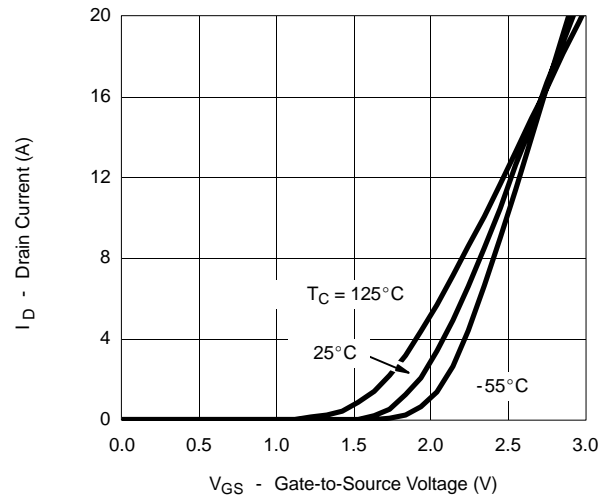

On-Resistance vs. Drain Current

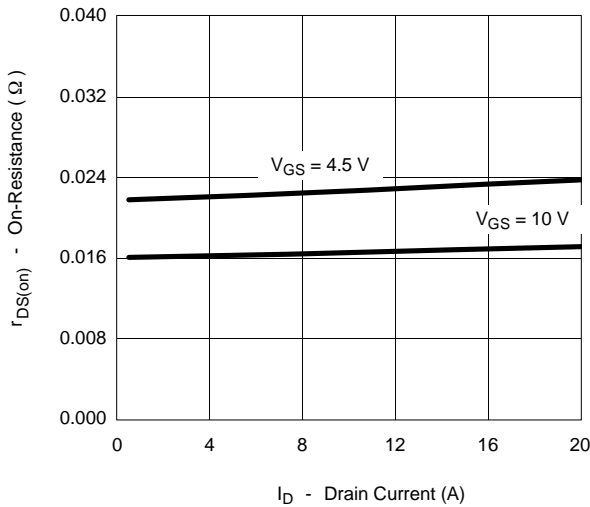

Capacitance

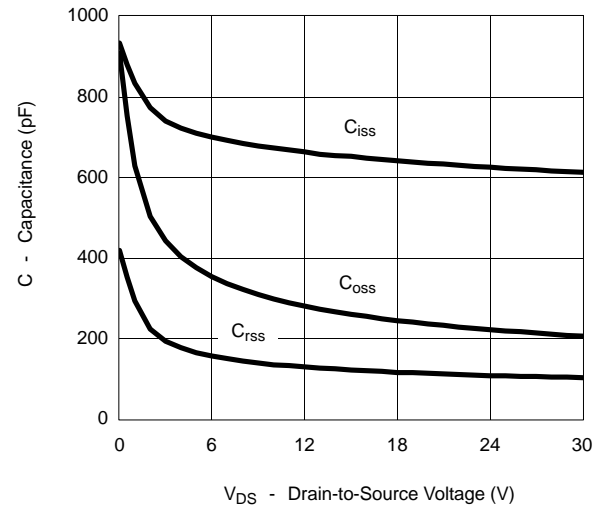

Gate Charge

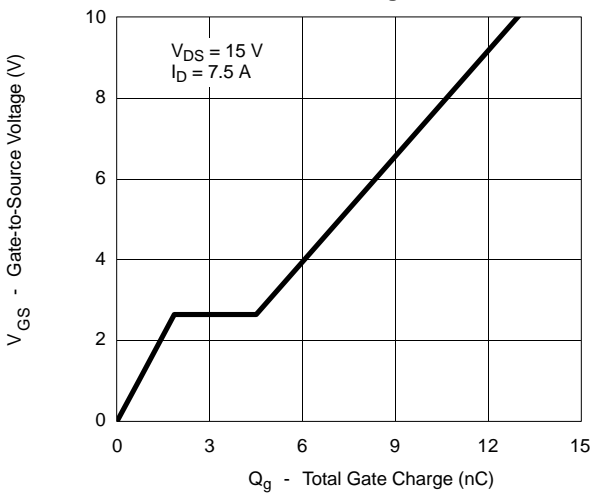

On-Resistance vs. Junction Temperature

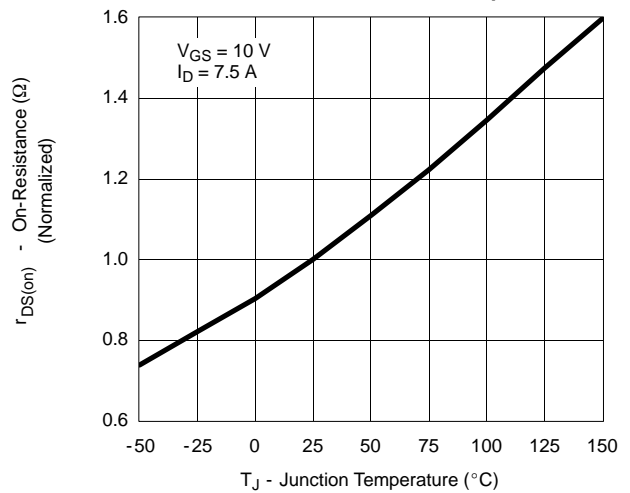

TYPICAL CHARACTERISTICS (25 °C UNLESS NOTED)

MOSFET

Source-Drain Diode Forward Voltage

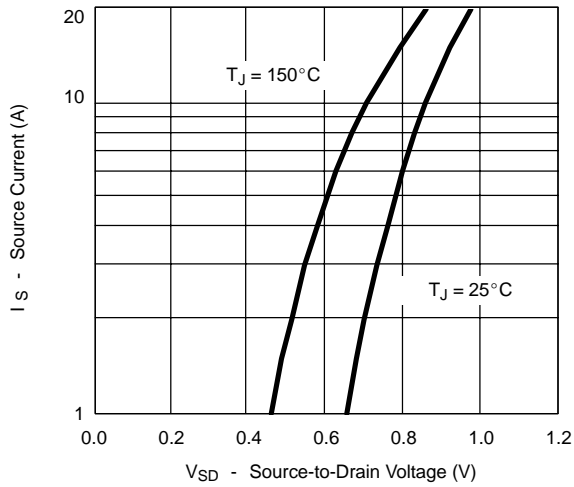

On-Resistance vs. Gate-to-Source Voltage

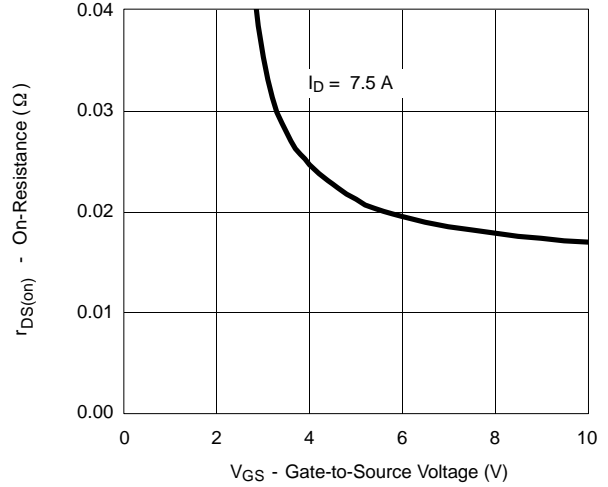

Threshold Voltage

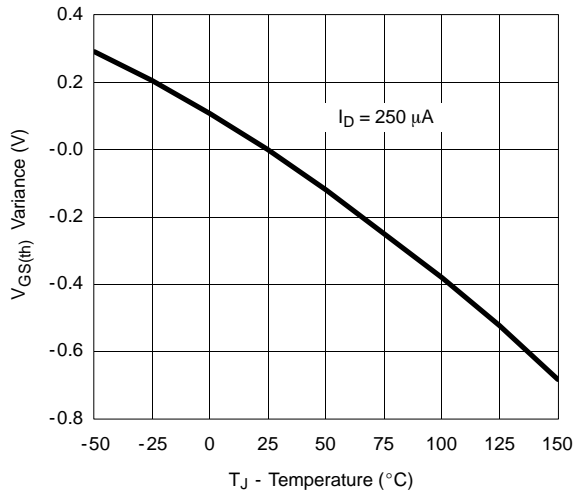

Single Pulse Power

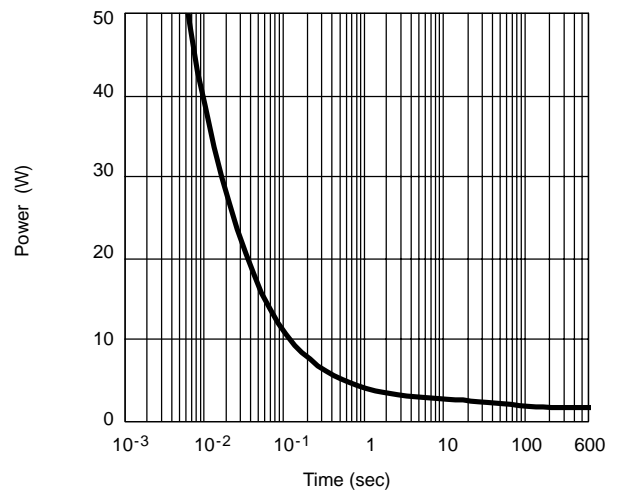

Normalized Thermal Transient Impedance, Junction-to-Ambient

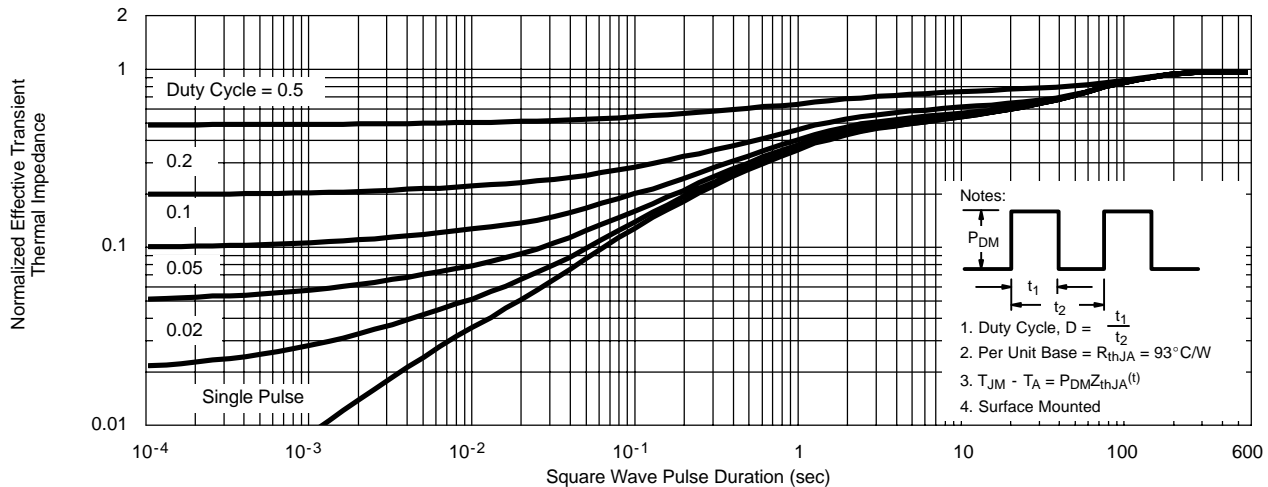



TYPICAL CHARACTERISTICS (25 °C UNLESS NOTED)

MOSFET

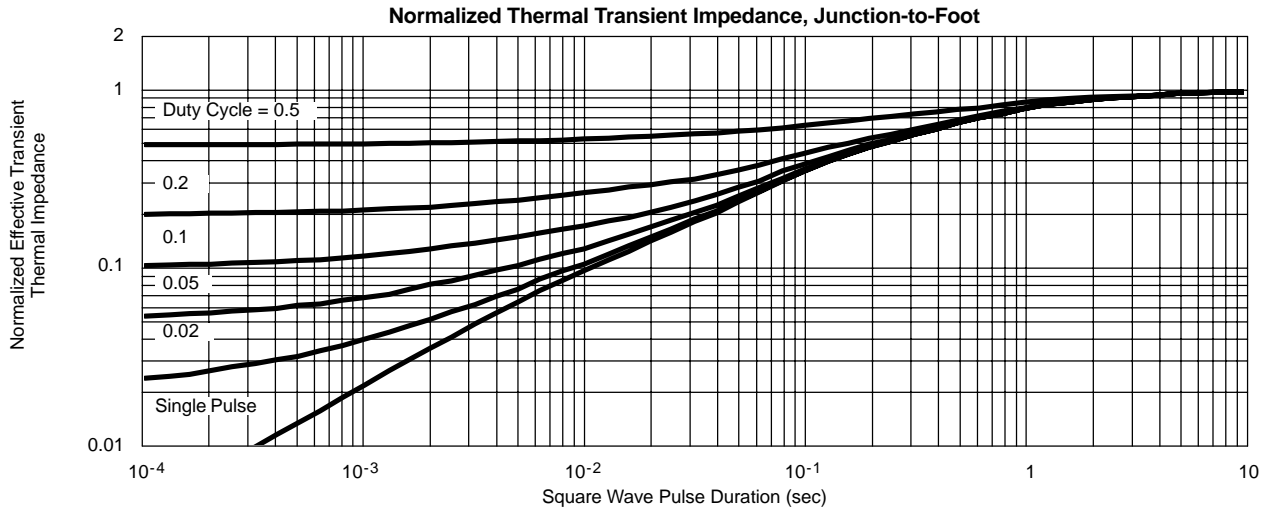

TYPICAL CHARACTERISTICS (25 °C UNLESS NOTED)

SCHOTTKY

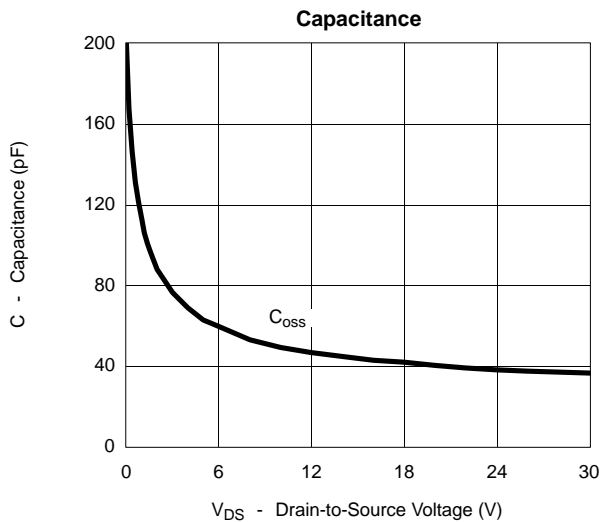
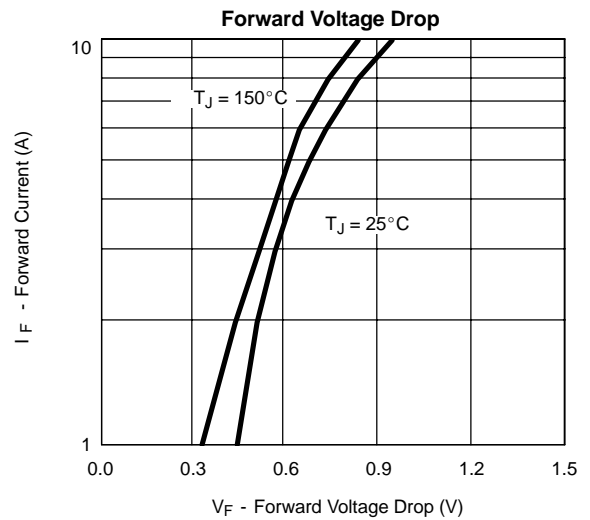
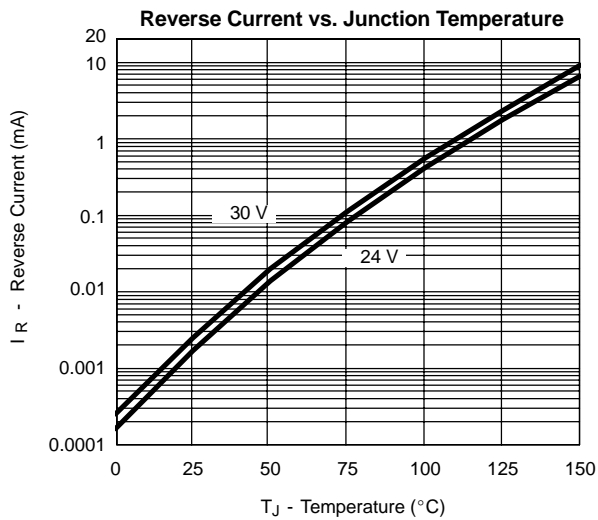



Disclaimer

All product specifications and data are subject to change without notice.

Vishay Intertechnology, Inc., its affiliates, agents, and employees, and all persons acting on its or their behalf (collectively, "Vishay"), disclaim any and all liability for any errors, inaccuracies or incompleteness contained herein or in any other disclosure relating to any product.

Vishay disclaims any and all liability arising out of the use or application of any product described herein or of any information provided herein to the maximum extent permitted by law. The product specifications do not expand or otherwise modify Vishay's terms and conditions of purchase, including but not limited to the warranty expressed therein, which apply to these products.

No license, express or implied, by estoppel or otherwise, to any intellectual property rights is granted by this document or by any conduct of Vishay.

The products shown herein are not designed for use in medical, life-saving, or life-sustaining applications unless otherwise expressly indicated. Customers using or selling Vishay products not expressly indicated for use in such applications do so entirely at their own risk and agree to fully indemnify Vishay for any damages arising or resulting from such use or sale. Please contact authorized Vishay personnel to obtain written terms and conditions regarding products designed for such applications.

Product names and markings noted herein may be trademarks of their respective owners.