

TC9270F, TC9270N

Σ-Δ MODULATION SYSTEM DA CONVERTER WITH A BUILT-IN DIGITAL ATTENUATOR DIGITAL FILTER

TC9270F, TC9270N are a 2nd order Σ-Δ modulation system 1-bit DA converter with a built-in 8 times over sampling FIR type digital filter developed for digital audio equipment.

As the de-emphasis filter has been incorporated, it is possible to construct small the digital filter ~ the analog output unit at a low price.

FEATURES

- Built-in 8 times over-sampling FIR type digital filter.
- Over sampling ratio (OSR) of Σ-Δ modulation circuit is 384fs or 256fs.
- Built-in digital de-emphasis filter.
- Permits microcontrollers to attenuate output levels (128 steps) during serial mode.
- Simultaneous outputs L-ch and R-ch.
- Compatible with double speed operation.
- Built-in Digital 0 Detection.
- Pin of OSCE can be stopped system clock.
- Characteristics of the digital filter and DA converter are as follows.

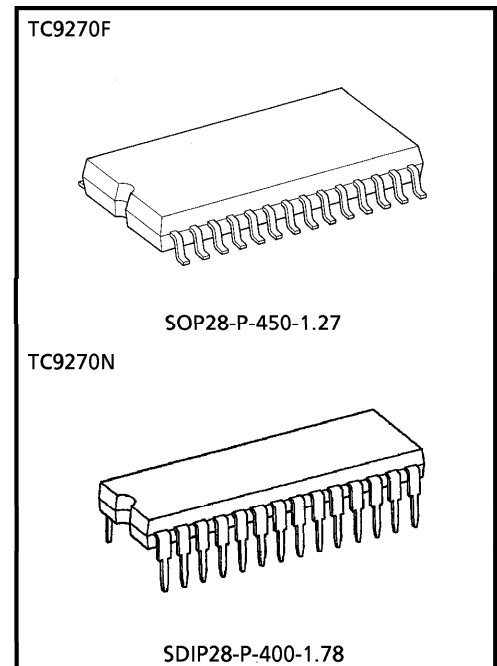

Weight
 SOP28-P-450-1.27 : 0.8g (Typ.)
 SDIP28-P-400-1.78 : 2.2g (Typ.)

DIGITAL FILTER

	DIGITAL FILTER	PASS-BAND RIPPLE	TRANSIENT BAND WIDTH	STOP-BAND SUPPRESSION
Standard Operation	8fs	± 0.003dB	20k~24.1kHz	- 68dB
Double Speed Operation	4fs	± 0.05dB	20k~24.1kHz	- 40dB

DA CONVERTER

	OSR	NOISE DISTORTION	S/N RATIO
Standard Operation	384fs	- 90dB (TYP)	100dB (TYP)
Double Speed Operation	192fs	- 87dB (TYP)	98dB (TYP)

- 2 kinds of package, Pin 28 flat package and Pin 28 DIP shrunk package.

PIN CONNECION

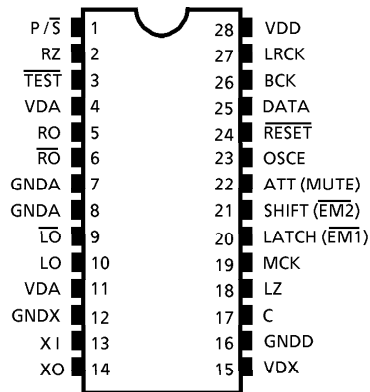

BLOCK DIAGRAM

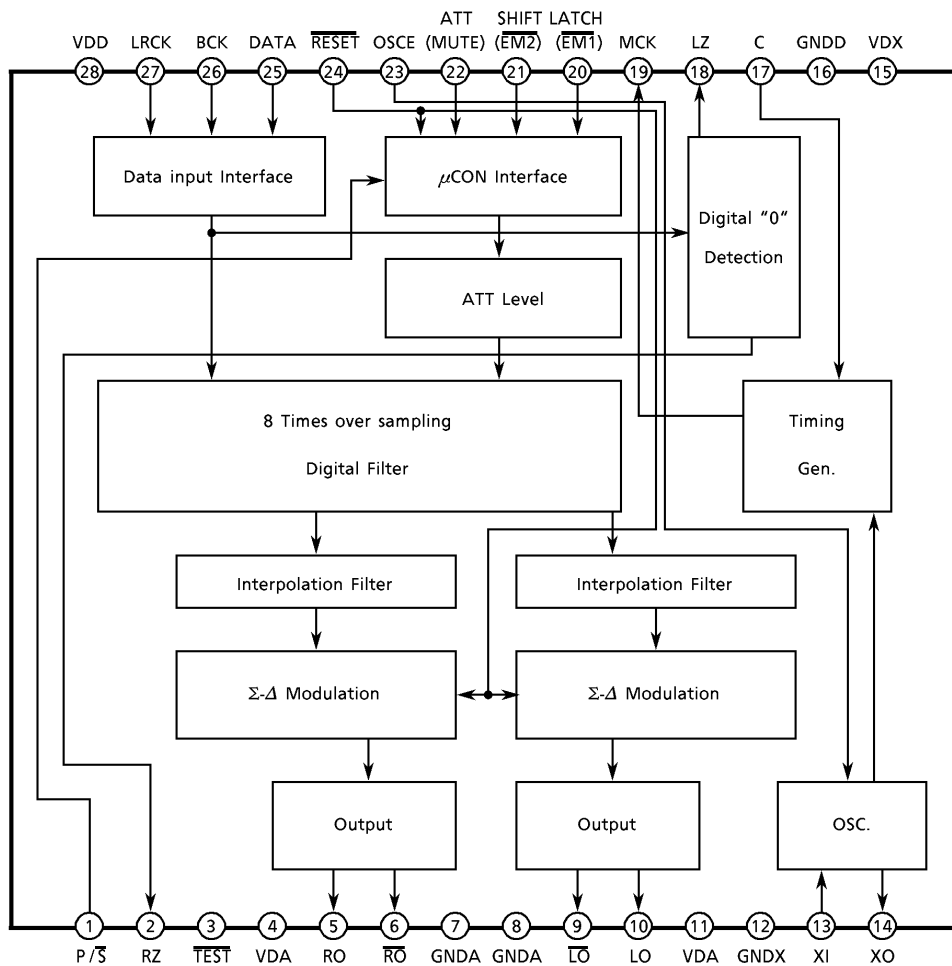

DESCRIPTION OF PIN FUNCTIONS

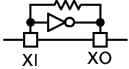
No.	SYMBOL	I/O	FUNCTION & OPERATION	REMARKS
1	P/S	I	Parallel control, serial control, switching pin.	Pull-up resistance
2	RZ	O	R-ch digital "0" detection output pin.	
3	$\overline{\text{TEST}}$	I	Test pin. Normally, use at "H".	Pull-up resistance
4	VDA	—	Analog power supply pin.	
5	RO	O	R-ch data forward output pin.	
6	$\overline{\text{RO}}$	O	R-ch data reverse output pin.	
7	GNDA	—	Analog ground pin.	
8	GNDA	—	Analog ground pin.	
9	$\overline{\text{LO}}$	O	L-ch data reverse output pin.	
10	LO	O	L-ch data forward output pin.	
11	VDA	—	Analog power supply pin.	
12	GNDX	—	Crystal oscillator ground Pin.	
13	XI	I	Crystal oscillator connection pin.	
14	XO	O	Connect to a crystal oscillator, generates needed frequency for the system.	
15	VDX	—	Crystal oscillator power supply pin.	
16	GNDD	—	Digital ground pin.	
17	C	I	Clock Select pin. "L" ; 256fs, "H" ; 384fs.	Pull-up resistance
18	LZ	O	L-ch digital "0" detection output pin.	
19	MCK	O	System clock output pin.	
20	LATCH (EM1)	I	Serial mode : Data latch signal input pin. Parallel mode : De-emphasis filter mode select pin.	Pull-up resistance
21	SHIFT (EM2)	I	Serial mode : Shift clock input pin. Parallel mode : De-emphasis filter mode select pin.	Pull-up resistance
22	ATT (MUTE)	I	Serial mode : Data input pin. Parallel mode : Soft mute control pin. ("H" Soft mute ON)	Pull-up resistance
23	OSCE	I	System clock control pin. "L" : System clock stop	Pull-up resistance
24	$\overline{\text{RESET}}$	I	Reset pin. "L" : Reset Σ - Δ circuit and ATT data 00 (HEX)	Pull-up resistance
25	DATA	I	Audio data input pin.	
26	BCK	I	Bit clock input pin.	
27	LRCK	I	LR clock input pin.	
28	VDD	—	Digital power supply pin.	

OPERATION DESCRIPTION FOR EACH BLOCK

1. CRYSTAL OSCILLATION CIRCUIT AND TIMING GENERATOR

Clock required for internal operation can be generated when crystal and capacitors are connected as shown in FIG.1 So external system clock signal may be applied to the X1 terminal at Pin 13. However care must be taken in using system clock since the S/N ratio and noise distortion performance can be greatly affected by Jitter, rise and fall characteristics...etc. of system clock.

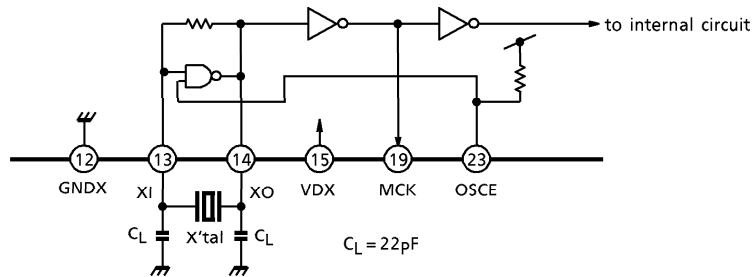

Use crystal with Low CI value and quick response.

FIG.1 Configuration of crystal oscillation circuit

The timing generator generates the timing signal for digital filter, digital attenuator, de-emphasis filter Σ - Δ demodulator circuit.

C (Pin 17)	XI INPUT CLOCK
L	256fs
H	384fs

Internal system clock can be stopped by OSCE pin but output of DAC will become unstable.

OSCE (Pin 23)	SYSTEM CLOCK
L	Stop
H	Normal operation

2. DATA INPUT CIRCUIT

Data and LRCK are taken into the shift register at the leading edge of BCK. As shown in the following timing example, it is necessary to input data and LRCK synchronized with the falling edge of BCK. In parallel mode ($P/\bar{S} = "H"$), input data length is fixed to 16 bits. In serial mode ($P/\bar{S} = "L"$), input data length can be selected to 16, 18, or 20bits.

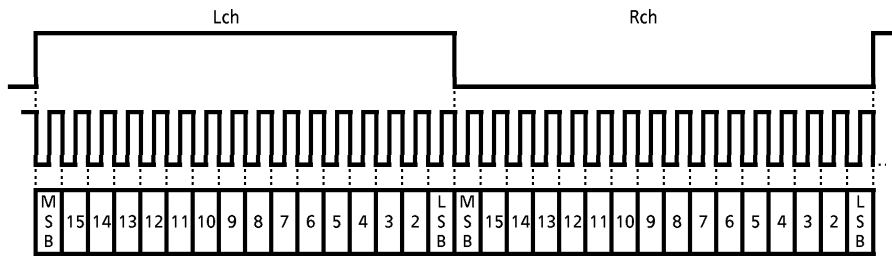

FIG.2a Example of input timing diagram (16 bit Input)

If BCK is 48fs or 64fs, please input DATA as follows.

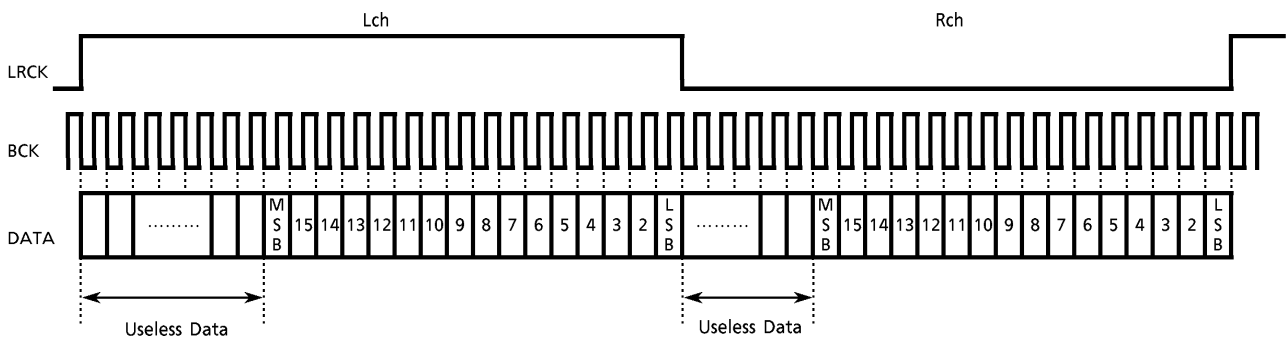
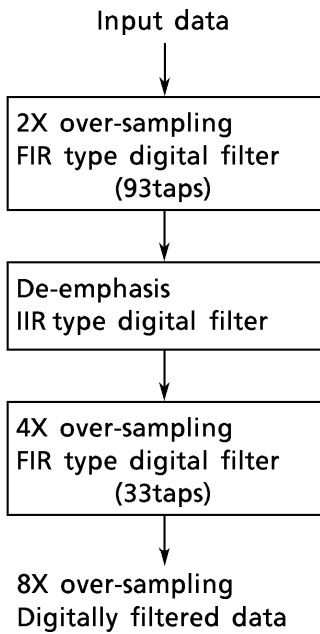

FIG.2b Example of input timing diagram (16 bit input)
When BCK = 48fs or 64fs.

3. DIGITAL FILTER, DE-EMPHASIS FILTER

Foldover noise component outside the band is removed by the 8 times over-sampling FIR type digital filter. The construction and basic characteristic of the digital filter are changed by the standard and double speed operations.

● Standard operation



● Double speed operation

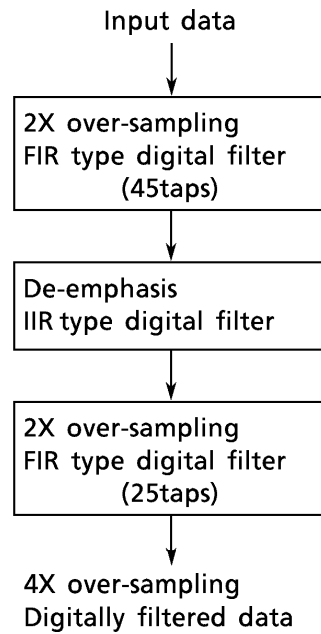

FIG.3 Construction of digital filter

Table-1 Basic characteristics of digital filter (fs = 44.1kHz)

MODE	PASS-BAND RIPPLE	TRANSIENT BAND WIDTH	STOP-BAND SUPPRESSION
Standard operation	± 0.003dB	20.0k~24.1kHz	- 68dB
Double speed operation	± 0.05dB	20.0k~24.1kHz	- 40dB

Digital filter frequency characteristics

● Standard operation

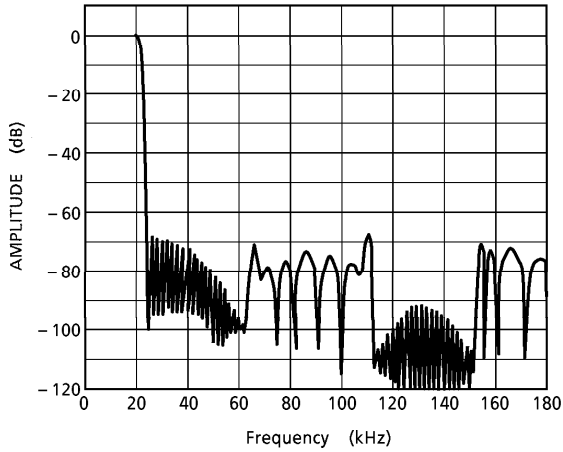

FIG4. Frequency characteristics (stop band)

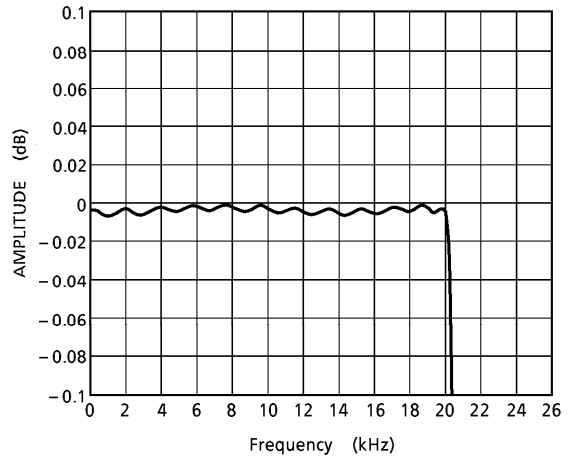

FIG5. Frequency characteristics (pass band)

● Double speed operation

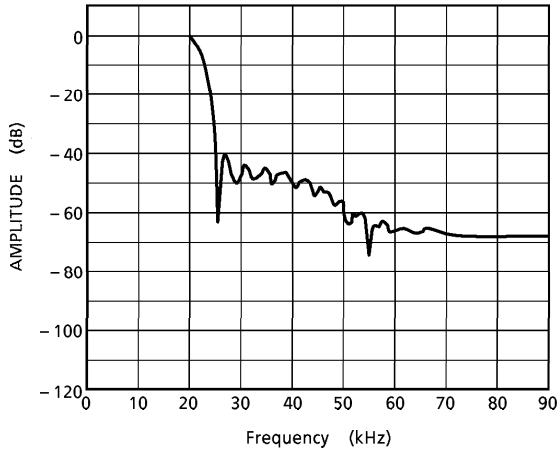

FIG6. Frequency characteristics (stop band)

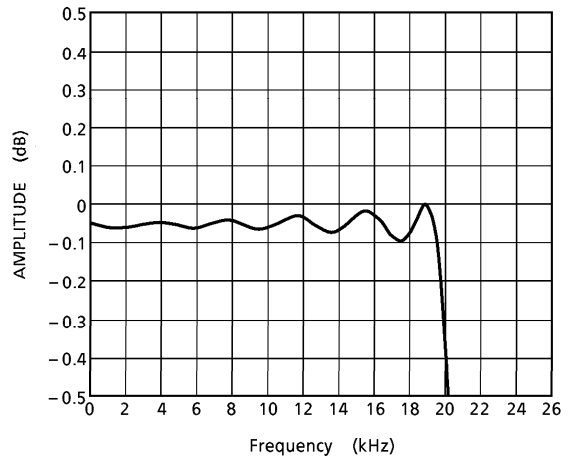

FIG7. Frequency characteristics (pass band)

The built-in digital de-emphasis circuit can be set to coup with sampling frequency of 32kHz, 44.1kHz, and 48kHz. The selection is done as shown in the following table.

Table.2 Truth table for de-emphasis filter selection

LATCH ($\overline{EM1}$)	H	H	L	L	(kHz)
SHIFT ($\overline{EM2}$)	H	L	H	L	
MODE (fs SELECT)	44.1	OFF	48	32	

Since the de-emphasis filter is a digital circuit, resistors, capacitors, and analog switches are not required. Filter construction is shown below.

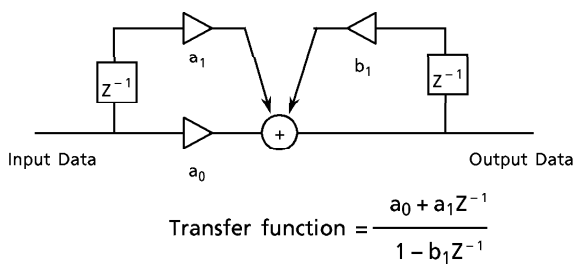

FIG.8 Digital De-emphasis filter construction

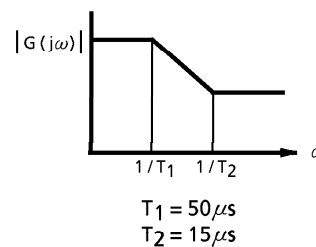

FIG.9 Filter Characteristics

4. INTERPOLATION FILTER AND DITHER CIRCUIT

The interpolation filter linearly interpolates 8 fs after the digital filter and over to 16fs in the dither circuit, DC offset and dither have been added to Data in order to areven noise by the idling pattern peculiar to Σ - Δ Modulation DAC. After adding the dither 384fs is over sampled in sample and hold circuit.

5. DA CONVERSION CIRCUIT

2 times Σ - Δ modulation DA converter for 2 channels (simultaneous output type) is incorporated in the TC9270F/N. The internal circuit construction is as shown in fig.10.

The conversion time for the bitstream output is 1/384fs. (in 384fs mode)

In case if CD application, fs = 44.1kHz

conversion time

$$T_{set} = (1 / 384 \times 44.1kHz) = 59.05ns$$

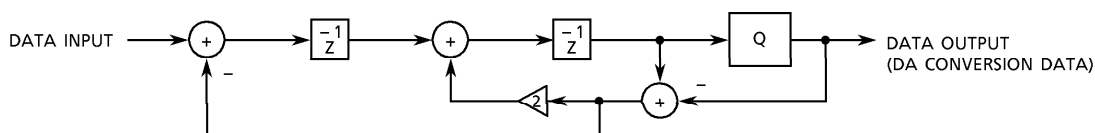

FIG.10 Σ - Δ Modulation circuit

6. The $\Sigma\Delta$ modulation section is designed to operate at same frequency as the master clock in both standard and double speed operation.

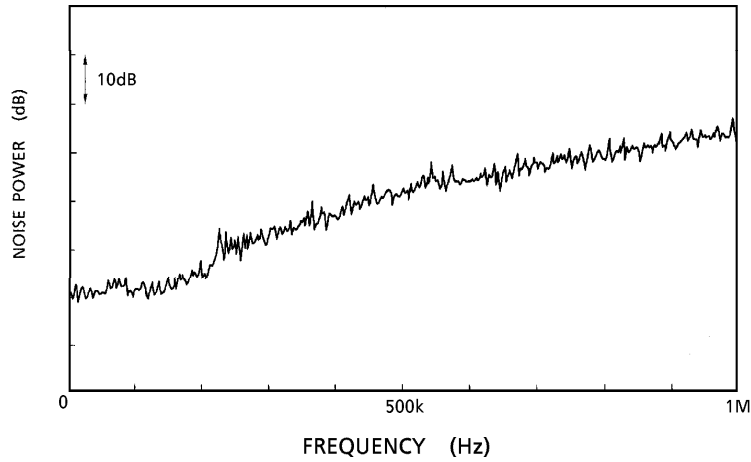

FIG.11 Noise shaping characteristics

7. DATA OUTPUT CIRCUIT

In the data output circuit, the 384fs or 256fs data are added to the data shift by rising and falling edge of clock. By differentiating these forward signal and the reverse signal in the external analog circuit, DA conversion of Low distortion factor high S/N ratio be obtained.

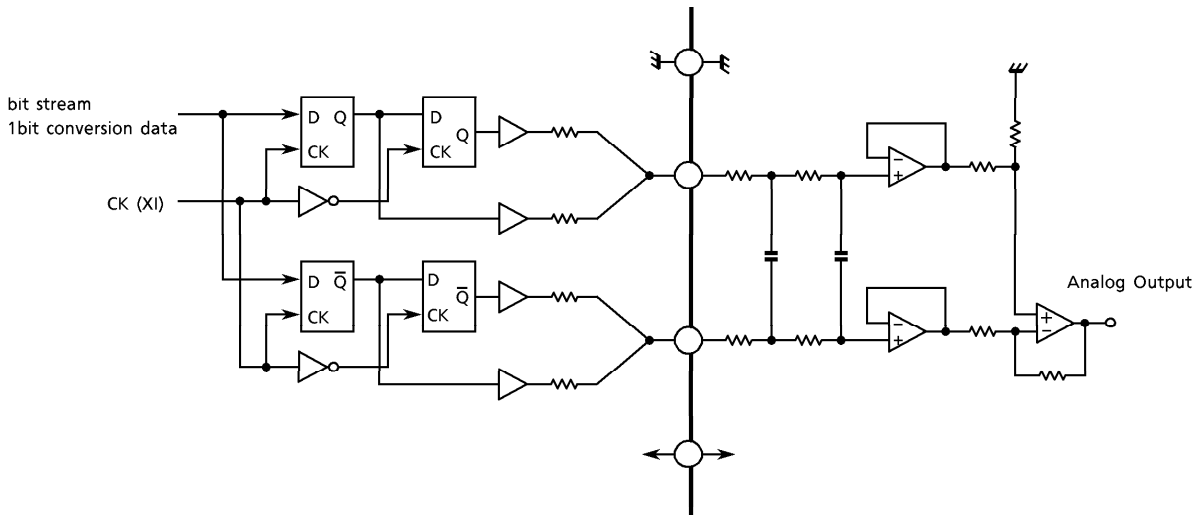

FIG.12 Data output circuit

8. INTERNAL CONTROL SIGNAL EXPLANATION

Parallel and serial control mode can be selected by the P/\bar{S} terminal. The controll functions are example as follow.

8-1 PARALLEL CONTROL MODE (P/\bar{S} PIN = H)

In parallel control mode, Pin 20, 21, 22 are set as follow.

Table-3 Terminal name at parallel mode

PIN No.	PIN NAME	FUNCTION
20	$\overline{EM1}$	De-emphasis control signal 1
21	$\overline{EM2}$	De-emphasis control signal 2
22	MUTE	If set to "H", digital mute for output is ON.

8-2 SERIAL CONTROL MODE (P/\bar{S} = L : FOR MICRO PROCESSOR CONTROL USE)

In serial control mode, the TC9270F/N can be controlled by micro processor. The control function of Pin 20, 21, 22 are as

Table-4 Terminal name at serial mode

PIN No.	PIN NAME	FUNCTION
20	LATCH	Data latch for input signal.
21	SHIFT	Shift clock signal input terminal
22	ATT	Att data input terminal

Latch and att signal are entered to the shift register of the LSI at the rising edge of the shift signal.

Also, the latch signal should rise after a minimum of $1.5\mu s$ of the last data is shifted to the register.

If the shift pulse is changed while catch is Low, Mis-operation may occur. Latch should be keep at Low until after D7 is shifted into the register.

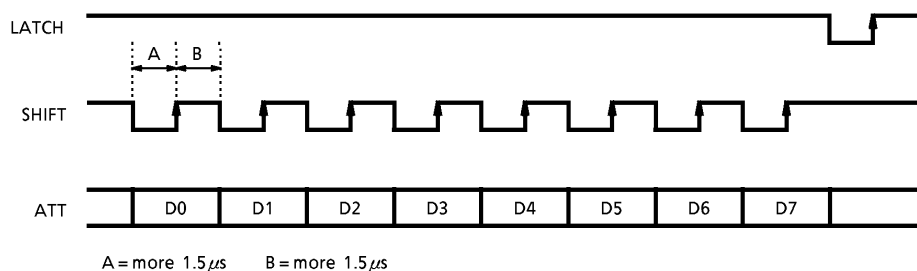

FIG.13 Example for serial control mode data

In serial control mode, the control features are as follow.

Table-5 Serial mode control

SERIAL INPUT DATA	CONTROL SIGNAL		
	0	1	
D6	AT6	0	1
D5	AT5	EMP	—
D4	AT4	CHS	MODE
D3	AT3	MONO	—
D2	AT2	HS	—
D1	AT1	μ EM2	BIT2
D0	AT0	μ EM1	BIT1

AT0~6 : Attenuation level setting
 μ EM1、2 : De-emphasis option set
 HS : Double speed mode setting
 BIT1、2 : Input data bit select
 MONO : Stereo / Mono setting
 CHS : Mono mode L / R mode
 EMP : De-emphasis ON / OF
 MODE : Digital filter fs selection

① Digital attenuator

D7 = L is the command for digital attenuator. If can be set to 28 levels as show below.

Table-6 Audio output of attenuation DATA

ATTENUATION CONTROL DATA D6~D0	AUDIO OUTPUT
7F (HEX)	0dB
7E (HEX)	- 0.069dB
⋮	⋮
01 (HEX)	- 42.076dB
00 (HEX)	- ∞

The attenuation value can be calculated from input data as follow :

$$ATT = 20\log(\text{input data} / 127)\text{dB}$$

Example : In case of attenuator = 7A

$$ATT = 20\log(122 / 127)\text{dB} = - 0.349\text{dB}$$

Digital attention change from 0dB to - ∞ with a slope of 1024s / f

② MONO, CHS

1) MONO is the commend for switching bit stereo and mono mode.

"H"- MONO "L"- STEREO

2) CHS selects the left or right channel in MONO mode.

"H"- R channel "L"- Left channel

(Note) : In parallel mode, both MONO and CHS are set to "L" an correspond to stereo mode.

Table-7 Mono, CHS control feature

MONO	CHS	CONTROL FEATURE
L	L	Stereo mode
L	H	
H	L	mono Left channel
H	H	mono Right channel

③ MODE、EMP、 μ EM1、 μ EM2

These control the fs selection and coefficient selection for De-emphasis filter.

Table-8 De-emphasis filter and digital filter coefficient setting

MODE	EMP	μ EM1	μ EM2	DIG. FILTER COEFFICIENT	DE-EMPHASIS COEFFICIENT
0	—	0	0	44.1 kHz	44.1 kHz
		0	1	44.1 kHz	OFF
		1	0	44.1 kHz	48 kHz
		1	1	44.1 kHz	32 kHz
1	0	0	0	44.1 kHz	OFF
		0	1	44.1 kHz	OFF
		1	0	48 kHz	OFF
		1	1	32 kHz	OFF
1	1	0	0	44.1 kHz	44.1 kHz
		0	1	44.1 kHz	OFF
		1	0	48 kHz	48 kHz
		1	1	32 kHz	32 kHz

④ HS

HS is for selecting normal speed mode and double speed mode.

"H" Double speed mode "L" - Normal In parallel mode it is fixed to "L" normal speed mode.

⑤ BIT1、BIT2

These are for selecting input data length.

Table-9 Input data length settings

BIT1	BIT2	INPUT DATA LENGTH
L	—	16
H	L	18
	H	20

9. ZERO DETECT FUNCTION

This device has a built-in input data digital zero detection function. If zero data is continued for over $(2^{15} / f_s)_{\text{sec}}$ "LZ" and "RZ" Pin become "H".

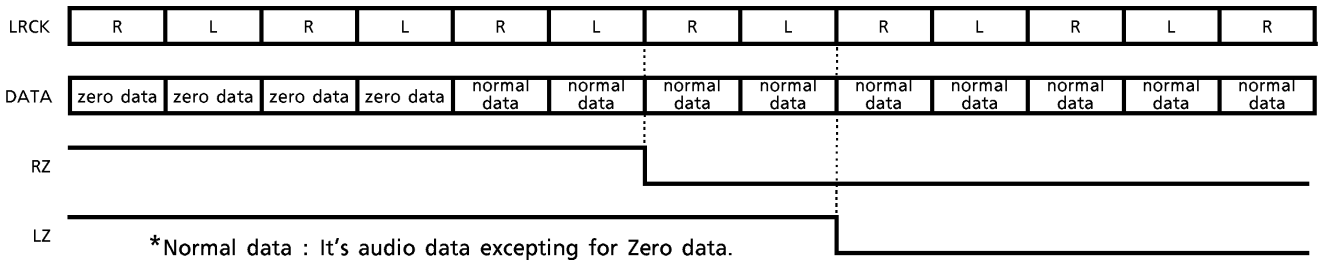

FIG.14 Zero detect cancel timing

10. RESET FUNCTION

The internal circuit can be reset by setting reset bit to "L".

In reset mode, outputs are as follow.

LO, \overline{LO} both fixed at "L"

RO, \overline{RO} both fixed at "H"

Output timing at reset is as follows.

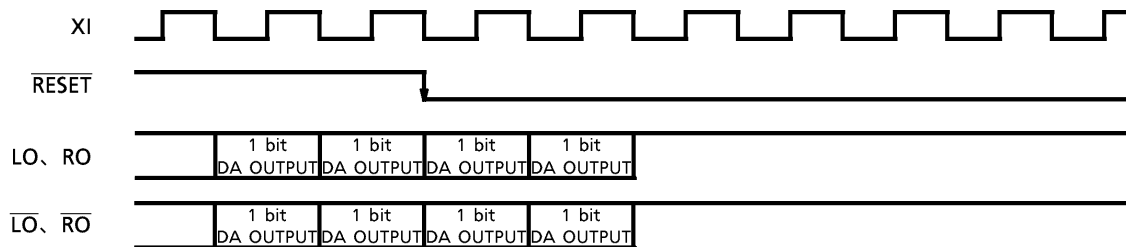

FIG.15 Reset and output relationship

The clock signal (XI input) is required for resetting internal circuit and output when setting reset to L.

MAXIMUM RATINGS (Ta = 25°C)

CHARACTERISTIC	SYMBOL	RATING	UNIT
Power Supply Voltage	V _{DD}	-0.3~6.0	V
	V _{DA}	-0.3~6.0	V
	V _{DX}	-0.3~6.0	V
Input Voltage	V _{in}	-0.3~V _{DD} +0.3	V
Power Dissipation	P _D	TC9270F : 600	mW
		TC9270N : 800	
Operating Temperature	T _{opr}	-35~85	°C
Storage Temperature	T _{stg}	-55~150	°C

ELECTRICAL CHARACTERISTICS (Unless otherwise specified, Ta = 25°C, V_{DD} = V_{DX} = V_{DA} = 5V)

DC CHARACTERISTICS

CHARACTERISTIC	SYMBOL	TEST CIR-CUIT	TEST CONDITION	MIN	TYP.	MAX	UNIT
Power Supply Voltage	V _{DD}	—	Ta = -35~85°C	4.5	5.0	5.5	V
	V _{DX}			4.5	5.0	5.5	
	V _{DA}			4.5	5.0	5.5	
Power Dissipation	I _{DD}	—	XI = 16.9MHz	—	30	40	mA
Input Voltage	"H" Level	—		V _{DD} × 0.7	—	V _{DD}	V
	"L" Level			0.0	—	V _{DD} × 0.3	
Input Current	"H" Level	—		-1.0	—	1.0	μA
	"L" Level						
Pull-up Resiso	RUP	—	1, 3, 17, 20, 21, 22, 23, Pin 24 Ta = 25°C, at 0V force measure current.	100	150	300	kΩ

AC CHARACTERISTICS (*) : Ta = 25°C

CHARACTERISTIC	SYMBOL	TEST CIR-CUIT	TEST CONDITION	MIN	TYP.	MAX	UNIT
Noise Distortion (*)	THD + N	1	1kHz Sine wave, full-scale input	—	-90	-85	dB
S/N Ratio (*)	S/N	1		95	100	—	dB
Dynamic Range (*)	DR	1	1kHz Sine wave, -60 Input Conversion	90	95	—	dB
Cross-talk (*)	CT	1	1kHz Sine wave, full-scale input	—	-95	-90	dB
Operating Frequency	f _{opr}	—		10	16.9344	19.2	MHz
Input Frequency	f _{LR}	—	LRCK duty cycle = 50%	30	44.1	100	kHz
	f _{BCK}		BCK duty cycle = 50%	0.96	1.4112	6.2	
Rise Time	t _r	—	LRCK, BCK (10%~90%)	—	—	15	ns
Fall Time	t _f						
Delay Time	t _d	—	BCK $\overline{\text{L}}$ Edge → LRCK, DATA	-50	—	50	ns

- **TEST CIRCUIT - 1** ; Application Circuit Example 1 is used.

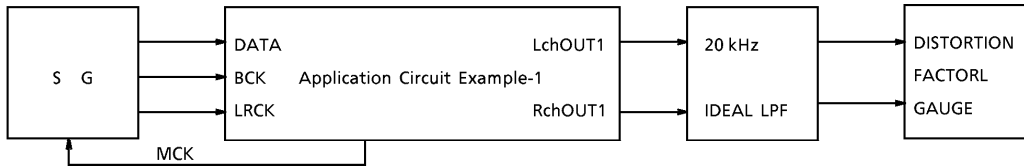

S G : ANRITSU MG-22A or equivalent
 LPF : SHIBASOKU 725C Built-In Filter
 Distortion Factor Gauge : SHIBASOKU 725C or equivalent

Measuring Item	Distortion factor gauge filter setting A weight
THD + N, CT	OFF
S/N, DR	ON

A weight : IEC - A or equivalent

- **AC CHARACTERISTIC POINT** ; (Input signal ; LRCK、BCK、 DATA)

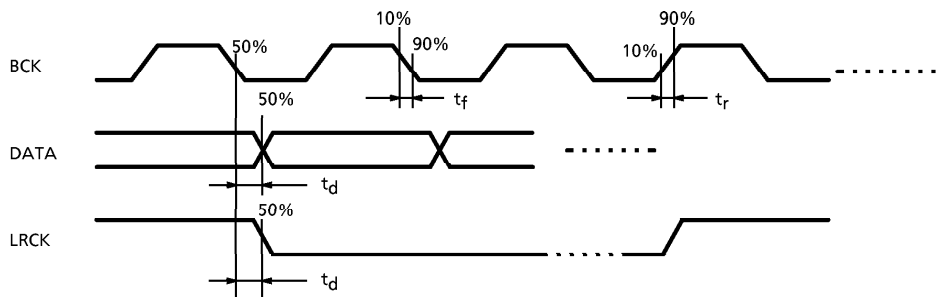

APPLICATION CIRCUIT

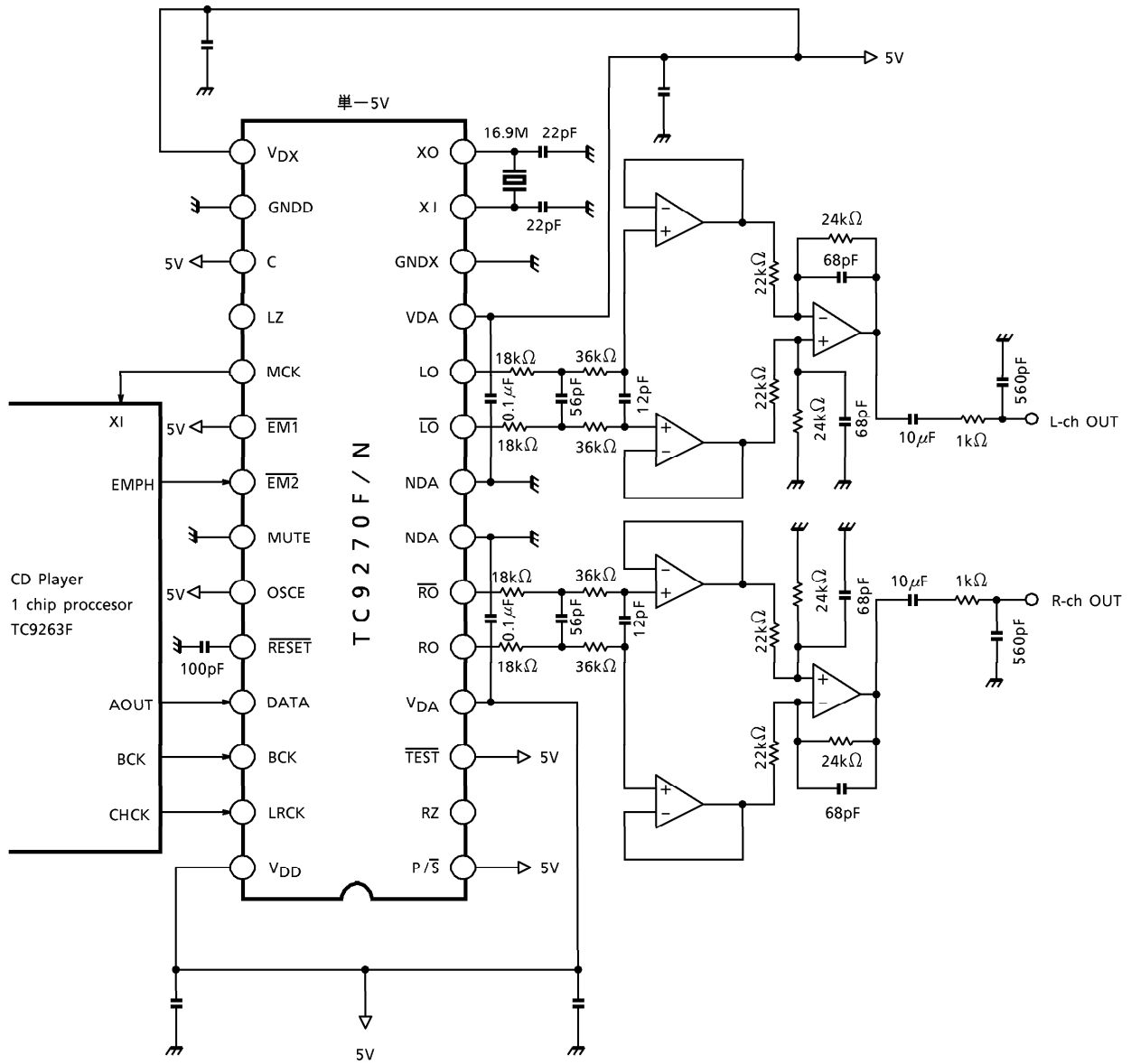

PACKAGE DIMENSIONS
SOP28-P-450-1.27

Unit : mm

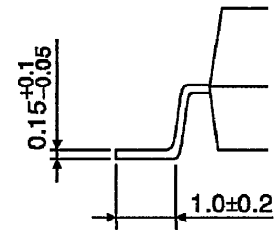
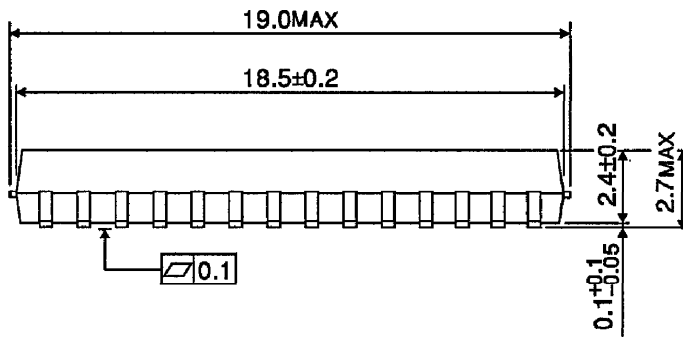
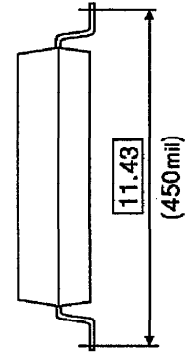
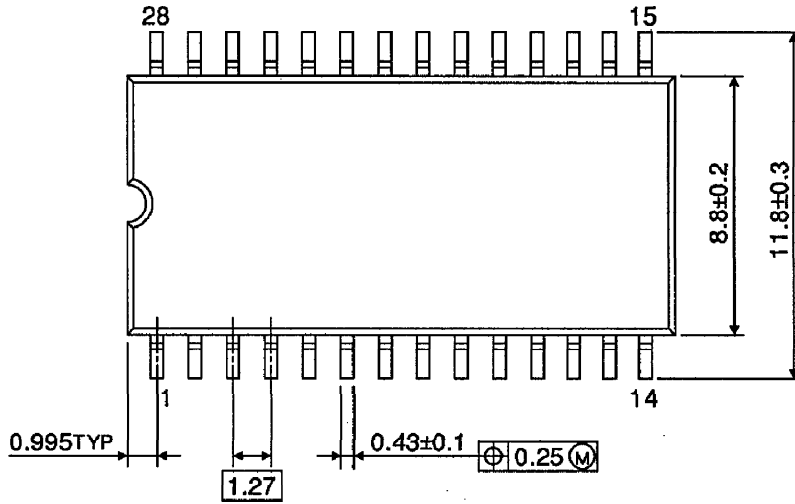

Weight : 0.8g (Typ.)

PACKAGE DIMENSIONS
SDIP28-P-400-1.78

Unit : mm

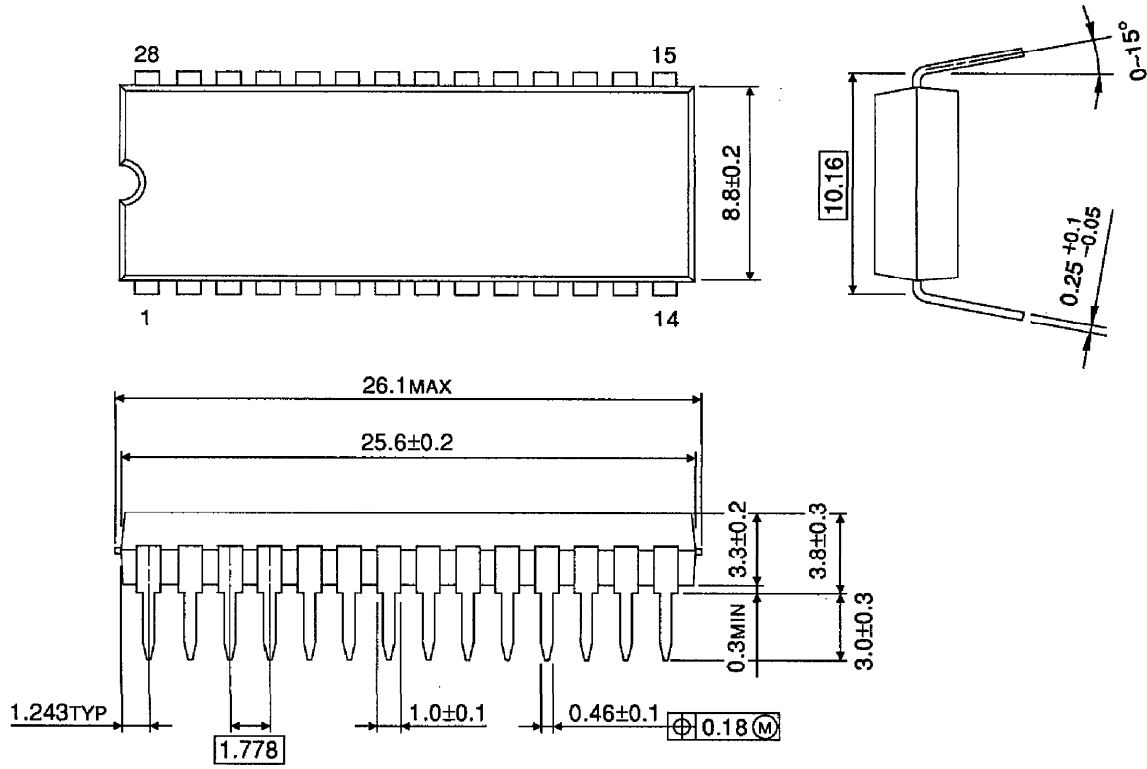

Weight : 2.2g (Typ.)

RESTRICTIONS ON PRODUCT USE

000707EBA

- TOSHIBA is continually working to improve the quality and reliability of its products. Nevertheless, semiconductor devices in general can malfunction or fail due to their inherent electrical sensitivity and vulnerability to physical stress. It is the responsibility of the buyer, when utilizing TOSHIBA products, to comply with the standards of safety in making a safe design for the entire system, and to avoid situations in which a malfunction or failure of such TOSHIBA products could cause loss of human life, bodily injury or damage to property. In developing your designs, please ensure that TOSHIBA products are used within specified operating ranges as set forth in the most recent TOSHIBA products specifications. Also, please keep in mind the precautions and conditions set forth in the "Handling Guide for Semiconductor Devices," or "TOSHIBA Semiconductor Reliability Handbook" etc..
- The TOSHIBA products listed in this document are intended for usage in general electronics applications (computer, personal equipment, office equipment, measuring equipment, industrial robotics, domestic appliances, etc.). These TOSHIBA products are neither intended nor warranted for usage in equipment that requires extraordinarily high quality and/or reliability or a malfunction or failure of which may cause loss of human life or bodily injury ("Unintended Usage"). Unintended Usage include atomic energy control instruments, airplane or spaceship instruments, transportation instruments, traffic signal instruments, combustion control instruments, medical instruments, all types of safety devices, etc.. Unintended Usage of TOSHIBA products listed in this document shall be made at the customer's own risk.
- The products described in this document are subject to the foreign exchange and foreign trade laws.
- The information contained herein is presented only as a guide for the applications of our products. No responsibility is assumed by TOSHIBA CORPORATION for any infringements of intellectual property or other rights of the third parties which may result from its use. No license is granted by implication or otherwise under any intellectual property or other rights of TOSHIBA CORPORATION or others.
- The information contained herein is subject to change without notice.

This datasheet has been download from:

www.datasheetcatalog.com

Datasheets for electronics components.