

TPS2211

SINGLE-SLOT PC CARD POWER INTERFACE SWITCH FOR PARALLEL PCMCIA CONTROLLERS

SLVS156E – JULY 1997 – REVISED JANUARY 2001

- Fully Integrated V_{CC} and V_{pp} Switching for Single-Slot PC Card™ Interface
- Low $r_{DS(on)}$ (90-m Ω 5-V V_{CC} Switch and 3.3-V V_{CC} Switch)
- Compatible With Controllers From Cirrus, Ricoh, O₂Micro, Intel, and Texas Instruments
- 3.3-V Low-Voltage Mode
- Meets PC Card Standards
- 12-V Supply Can Be Disabled Except During 12-V Flash Programming
- Short-Circuit and Thermal Protection
- Space-Saving 16-Pin SSOP (DB)
- Compatible With 3.3-V, 5-V, and 12-V PC Cards
- Break-Before-Make Switching

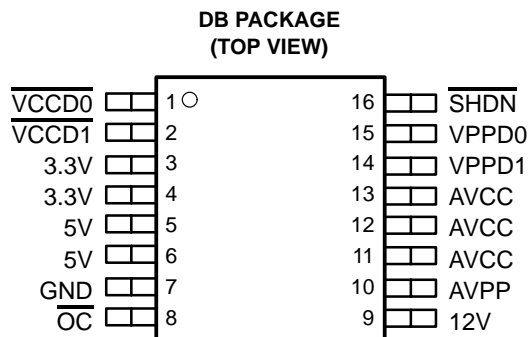

description

The TPS2211 PC Card power-interface switch provides an integrated power-management solution for a single PC Card. All of the discrete power MOSFETs, a logic section, current limiting, and thermal protection for PC Card control are combined on a single integrated circuit, using the Texas Instruments LinBiCMOS™ process. The circuit allows the distribution of 3.3-V, 5-V, and/or 12-V card power, and is compatible with many PCMCIA controllers. The current-limiting feature eliminates the need for fuses, which reduces component count and improves reliability. Current-limit reporting can help the user isolate a system fault to the PC Card.

The TPS2211 features a 3.3-V low-voltage mode that allows for 3.3-V switching without the need for 5 V. Bias power can be derived from either the 3.3-V or 5-V inputs. This facilitates low-power system designs such as sleep mode and pager mode where only 3.3 V is available.

End equipment for the TPS2211 includes notebook computers, desktop computers, personal digital assistants (PDAs), digital cameras, and bar-code scanners.

AVAILABLE OPTIONS

| T_A | PACKAGED DEVICE | CHIP FORM (Y) |
|---------------|-----------------------|------------------|
| | SMALL OUTLINE (DB) | |
| -40°C to 85°C | TPS2211DBR | TPS2211Y |

The DB package is only available taped and reeled, indicated by the R suffix on the device type.



Please be aware that an important notice concerning availability, standard warranty, and use in critical applications of Texas Instruments semiconductor products and disclaimers thereto appears at the end of this data sheet.

PC Card is a trademark of PCMCIA (Personal Computer Memory Card International Association).
LinBiCMOS is a trademark of Texas Instruments Incorporated.

PRODUCTION DATA information is current as of publication date. Products conform to specifications per the terms of Texas Instruments standard warranty. Production processing does not necessarily include testing of all parameters.



POST OFFICE BOX 655303 • DALLAS, TEXAS 75265

Copyright © 2001, Texas Instruments Incorporated

TPS2211 SINGLE-SLOT PC CARD POWER INTERFACE SWITCH FOR PARALLEL PCMCIA CONTROLLERS

SLVS156E – JULY 1997 – REVISED JANUARY 2001

typical PC-card power-distribution application

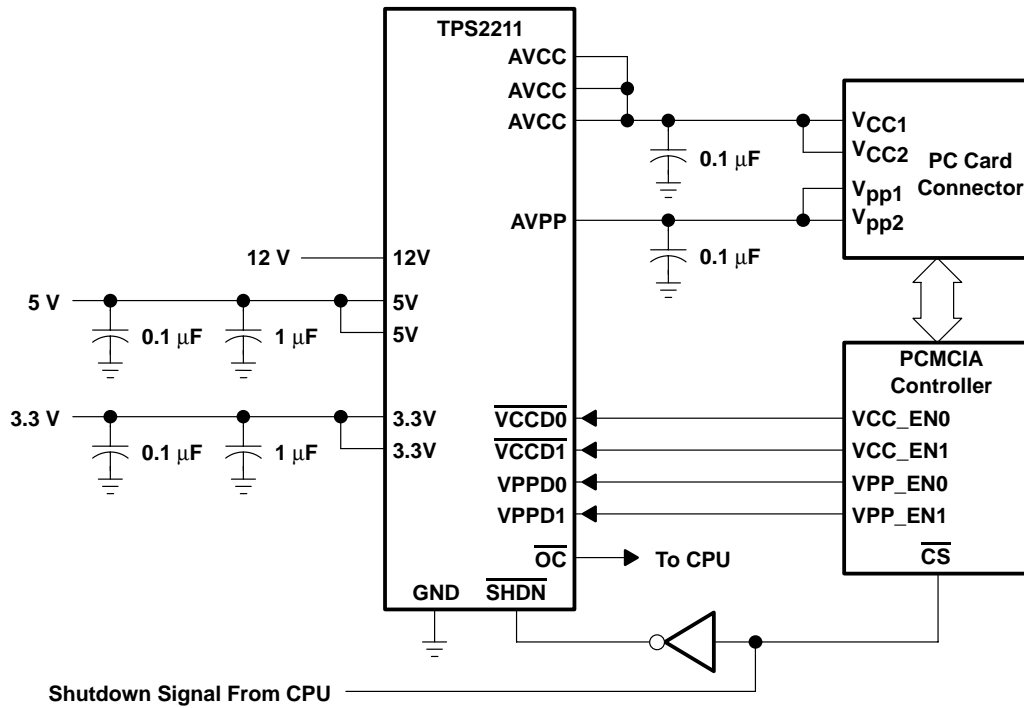

TPS2211 SINGLE-SLOT PC CARD POWER INTERFACE SWITCH FOR PARALLEL PCMCIA CONTROLLERS

SLVS156E – JULY 1997 – REVISED JANUARY 2001

TPS2211Y chip information

This chip, when properly assembled, displays characteristics similar to those of the TPS2211. Thermal compression or ultrasonic bonding may be used on the doped-aluminum bonding pads. The chips may be mounted with conductive epoxy or a gold-silicon preform.

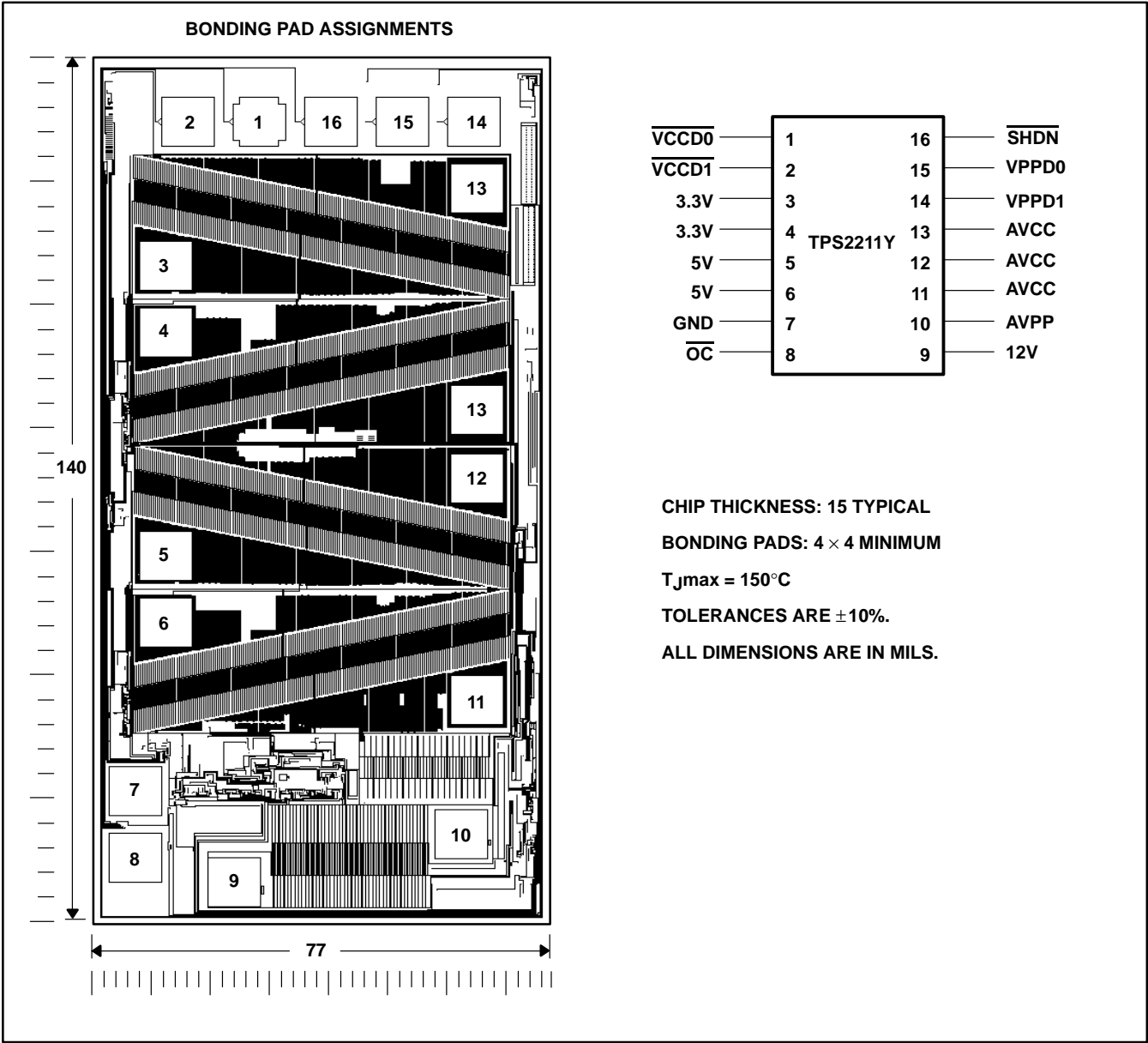

TPS2211
SINGLE-SLOT PC CARD POWER INTERFACE SWITCH
FOR PARALLEL PCMCIA CONTROLLERS

SLVS156E – JULY 1997 – REVISED JANUARY 2001

Terminal Functions

| TERMINAL NAME | NO. | I/O | DESCRIPTION |
|--------------------|------------|-----|--|
| 3.3V | 3, 4 | I | 3.3-V V_{CC} input for card power and/or chip power if 5 V is not present |
| 5V | 5, 6 | I | 5-V V_{CC} input for card power and/or chip power |
| 12V | 9 | I | 12-V V_{pp} input card power |
| AVCC | 11, 12, 13 | O | Switched output that delivers 0 V, 3.3-V, 5-V, or high impedance to card |
| AVPP | 10 | O | Switched output that delivers 0 V 3.3-V, 5-V, 12-V, or high impedance to card |
| GND | 7 | | Ground |
| \overline{OC} | 8 | O | Logic-level overcurrent reporting output that goes low when an overcurrent conditions exists |
| \overline{SHDN} | 16 | I | Logic input that shuts down the TPS2211 and sets all power outputs to high-impedance state |
| $\overline{VCCD0}$ | 1 | I | Logic input that controls voltage of AVCC (see control-logic table) |
| $\overline{VCCD1}$ | 2 | I | Logic input that controls voltage of AVCC (see control-logic table) |
| $\overline{VPPD0}$ | 15 | I | Logic input that controls voltage of AVPP (see control-logic table) |
| $\overline{VPPD1}$ | 14 | I | Logic input that controls voltage of AVPP (see control-logic table) |

absolute maximum ratings over operating free-air temperature (unless otherwise noted)†

| | | |
|--|---------------------|------------------------------|
| Input voltage range for card power: | $V_{I(5V)}$ | -0.3 V to 7 V |
| | $V_{I(3.3V)}$ | -0.3 V to 7 V |
| | $V_{I(12V)}$ | -0.3 V to 14 V |
| Logic input voltage | | -0.3 V to 7 V |
| Continuous total power dissipation | | See Dissipation Rating Table |
| Output current (each card): | $I_{O(VCC)}$ | internally limited |
| | $I_{O(VPP)}$ | internally limited |
| Operating virtual junction temperature range, T_J | | -40°C to 150°C |
| Operating free-air temperature range, T_A | | -40°C to 85°C |
| Storage temperature range, T_{stg} | | -55°C to 150°C |
| Lead temperature 1.6 mm (1/16 inch) from case for 10 seconds | | 260°C |

† Stresses beyond those listed under “absolute maximum ratings” may cause permanent damage to the device. These are stress ratings only, and functional operation of the device at these or any other conditions beyond those indicated under “recommended operating conditions” is not implied. Exposure to absolute-maximum-rated conditions for extended periods may affect device reliability.

DISSIPATION RATING TABLE

| PACKAGE | $T_A \leq 25^\circ\text{C}$ POWER RATING | DERATING FACTOR ABOVE $T_A = 25^\circ\text{C}$ | $T_A = 70^\circ\text{C}$ POWER RATING | $T_A = 85^\circ\text{C}$ POWER RATING |
|---------|---|---|--|--|
| DB | 775 mW | 6.2 mW/°C | 496 mW | 403 mW |

These devices are mounted on an FR4 board with no special thermal considerations.

recommended operating conditions

| | | MIN | MAX | UNIT |
|---|---------------|-----|------|------|
| Input voltage, V_I | $V_{I(5V)}$ | 0 | 5.25 | V |
| | $V_{I(3.3V)}$ | 0 | 5.25 | V |
| | $V_{I(12V)}$ | 0 | 13.5 | V |
| Output current | $I_{O(AVCC)}$ | | 1 | A |
| | $I_{O(AVPP)}$ | | 150 | mA |
| Operating virtual junction temperature, T_J | | -40 | 125 | °C |



TPS2211

SINGLE-SLOT PC CARD POWER INTERFACE SWITCH FOR PARALLEL PCMCIA CONTROLLERS

SLVS156E – JULY 1997 – REVISED JANUARY 2001

electrical characteristics, $T_A = -40^\circ\text{C}$ to 85°C (unless otherwise noted)

power switch

| PARAMETER | | TEST CONDITIONS† | TPS2211 | | | UNIT |
|-------------------|------------------------------------|--|---|-----|-----|---------------|
| | | | MIN | TYP | MAX | |
| Switch resistance | 5 V to AVCC | $V_{I(5V)} = 5\text{ V}$ | | 50 | 90 | m Ω |
| | 3.3 V to AVCC | $V_{I(5V)} = 5\text{ V}, V_{I(3.3V)} = 3.3\text{ V}$ | | 48 | 90 | |
| | 3.3 V to AVCC | $V_{I(5V)} = 0\text{ V}, V_{I(3.3V)} = 3.3\text{ V}$ | | 48 | 90 | |
| | 5 V to AVPP | $T_J = 25^\circ\text{C}$ | | | 6 | Ω |
| | 3.3 V to AVPP | $T_J = 25^\circ\text{C}$ | | | 6 | |
| | 12 V to AVPP | $T_J = 25^\circ\text{C}$ | | | 1 | |
| $V_{O(AVPP)}$ | Clamp low voltage | I_{pp} at 10 mA | | | 0.8 | V |
| $V_{O(AVCC)}$ | Clamp low voltage | I_{CC} at 10 mA | | | 0.8 | V |
| I_{lkg} | Leakage current | I_{pp} high-impedance state | $T_A = 25^\circ\text{C}$ | 1 | 10 | μA |
| | | | $T_A = 85^\circ\text{C}$ | | 50 | |
| | I_{CC} high-impedance state | $T_A = 25^\circ\text{C}$ | 1 | 10 | | |
| | | $T_A = 85^\circ\text{C}$ | | 50 | | |
| I_I | Input current | $V_{I(5V)} = 5\text{ V}$ | $V_{O(AVCC)} = 5\text{ V}, V_{O(AVPP)} = 12\text{ V}$ | 40 | 150 | μA |
| | | $V_{I(5V)} = 0\text{ V}, V_{I(3.3V)} = 3.3\text{ V}$ | $V_{O(AVCC)} = 3.3\text{ V}, V_{O(AVPP)} = 12\text{ V}$ | 40 | 150 | |
| | | Shutdown mode | $V_{O(AVCC)} = V_{O(AVPP)} = \text{Hi-Z}$ | | 1 | |
| I_{OS} | Short-circuit output-current limit | $I_{O(AVCC)}$ | $T_J = 85^\circ\text{C}$, output powered into a short to GND | 1 | 2.2 | A |
| | | $I_{O(AVPP)}$ | | 120 | 400 | mA |

† Pulse-testing techniques maintain junction temperature close to ambient temperature; thermal effects must be taken into account separately.

logic section

| PARAMETER | TEST CONDITIONS† | TPS2211 | | UNIT |
|-------------------------|---|---------------------|-----|---------------|
| | | MIN | MAX | |
| Logic input current | | | 1 | μA |
| Logic input high level | | 2 | | V |
| Logic input low level | | | 0.8 | V |
| Logic output high level | $V_{I(5V)} = 5\text{ V}, I_O = 1\text{ mA}$ | $V_{I(5V)} - 0.4$ | | V |
| | $V_{I(5V)} = 0\text{ V}, I_O = 1\text{ mA}, V_{I(3.3V)} = 3.3\text{ V}$ | $V_{I(3.3V)} - 0.4$ | | |
| Logic output low level | $I_O = 1\text{ mA}$ | | 0.4 | V |

† Pulse-testing techniques maintain junction temperature close to ambient temperature; thermal effects must be taken into account separately.

TPS2211
SINGLE-SLOT PC CARD POWER INTERFACE SWITCH
FOR PARALLEL PCMCIA CONTROLLERS

SLVS156E – JULY 1997 – REVISED JANUARY 2001

electrical characteristics, $T_A = 25^\circ\text{C}$ (unless otherwise noted)

power switch

| PARAMETER | | TEST CONDITIONS† | TPS2211Y | | | UNIT |
|-------------------|-------------------|--|---|-----|-----|------|
| | | | MIN | TYP | MAX | |
| Switch resistance | 5 V to AVCC | $V_{I(5V)} = 5\text{ V}$ | 50 | | | mΩ |
| | 3.3 V to AVCC | $V_{I(5V)} = 5\text{ V}, V_{I(3.3V)} = 3.3\text{ V}$ | 48 | | | |
| | 3.3 V to AVCC | $V_{I(5V)} = 0\text{ V}, V_{I(3.3V)} = 3.3\text{ V}$ | 48 | | | |
| | 5 V to AVPP | $T_J = 25^\circ\text{C}$ | 4.3 | | | Ω |
| | 3.3 V to AVPP | $T_J = 25^\circ\text{C}$ | 4.3 | | | |
| | 12 V to AVPP | $T_J = 25^\circ\text{C}$ | 0.5 | | | |
| $V_{O(AVPP)}$ | Clamp low voltage | I_{pp} at 10 mA | 0.28 | | | V |
| $V_{O(AVCC)}$ | Clamp low voltage | I_{pp} at 10 mA | 0.28 | | | V |
| I_{lkg} | Leakage current | I_{pp} high-impedance state | 1 | | | μA |
| | | I_{CC} high-impedance state | 1 | | | |
| I_I | Input current | $V_I = 5\text{ V}$ | $V_{O(AVCC)} = 5\text{ V}, V_{O(AVPP)} = 12\text{ V}$ | | | μA |
| | | $V_{I(5V)} = 5\text{ V}, V_{I(3.3V)} = 3.3\text{ V}$ | $V_{O(AVCC)} = 3.3\text{ V}, V_{O(AVPP)} = 12\text{ V}$ | | | |

† Pulse-testing techniques maintain junction temperature close to ambient temperature; thermal effects must be taken into account separately.

switching characteristics‡

| PARAMETER | | TEST CONDITIONS§ | TPS2211, TPS2211Y | | | UNIT |
|-----------|---------------------------------|---|-------------------|-----|-----|------|
| | | | MIN | TYP | MAX | |
| t_r | Rise times, output | $V_{O(AVCC)}$ | 2.8 | | | ms |
| | | $V_{O(AVPP)}$ | 6.4 | | | |
| t_f | Fall times, output | $V_{O(AVCC)}$ | 4.5 | | | |
| | | $V_{O(AVPP)}$ | 12 | | | |
| t_{pd} | Propagation delay (see Figure1) | $V_I(VPPD0)$ to $V_{O(AVPP)}$ | t_{on} | 6.8 | | ms |
| | | | t_{off} | 18 | | |
| | | $V_I(\overline{VCCD1})$ to $V_{O(AVCC)} (3.3V)$ | t_{on} | 4 | | |
| | | | t_{off} | 17 | | |
| | | $V_I(\overline{VCCD0})$ to $V_{O(AVCC)} (5V)$ | t_{on} | 6.6 | | |
| | | | t_{off} | 17 | | |

‡ Switching Characteristics are with $C_L = 150\text{ }\mu\text{F}$.

§ Refer to Parameter Measurement Information



TPS2211
SINGLE-SLOT PC CARD POWER INTERFACE SWITCH
FOR PARALLEL PCMCIA CONTROLLERS

SLVS156E – JULY 1997 – REVISED JANUARY 2001

PARAMETER MEASUREMENT INFORMATION

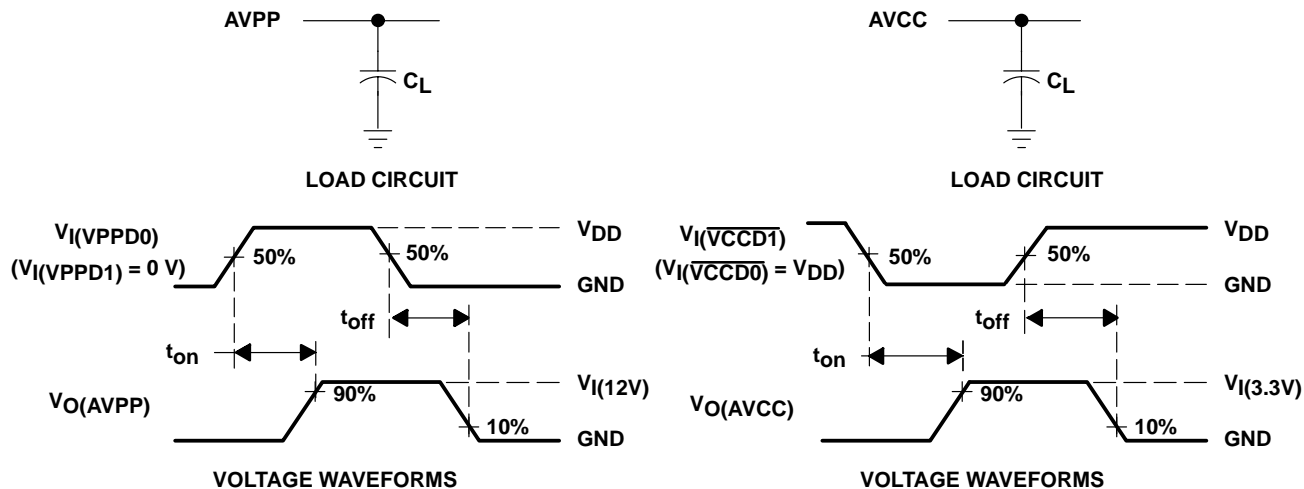

Figure 1. Test Circuits and Voltage Waveforms

Table of Timing Diagrams

| | FIGURE |
|---|--------|
| AVCC Propagation Delay and Rise Time With 1- μ F Load, 3.3-V Switch | 2 |
| AVCC Propagation Delay and Fall Time With 1- μ F Load, 3.3-V Switch | 3 |
| AVCC Propagation Delay and Rise Time With 150- μ F Load, 3.3-V Switch | 4 |
| AVCC Propagation Delay and Fall Time With 150- μ F Load, 3.3-V Switch | 5 |
| AVCC Propagation Delay and Rise Time With 1- μ F Load, 5-V Switch | 6 |
| AVCC Propagation Delay and Fall Time With 1- μ F Load, 5-V Switch | 7 |
| AVCC Propagation Delay and Rise Time With 150- μ F Load, 5-V Switch | 8 |
| AVCC Propagation Delay and Fall Time With 150- μ F Load, 5-V Switch | 9 |
| AVPP Propagation Delay and Rise Time With 1- μ F Load, 12-V Switch | 10 |
| AVPP Propagation Delay and Fall Time With 1- μ F Load, 12-V Switch | 11 |
| AVPP Propagation Delay and Rise Time With 150- μ F Load, 12-V Switch | 12 |
| AVPP Propagation Delay and Fall Time With 150- μ F Load, 12-V Switch | 13 |

TPS2211
SINGLE-SLOT PC CARD POWER INTERFACE SWITCH
FOR PARALLEL PCMCIA CONTROLLERS

SLVS156E – JULY 1997 – REVISED JANUARY 2001

PARAMETER MEASUREMENT INFORMATION

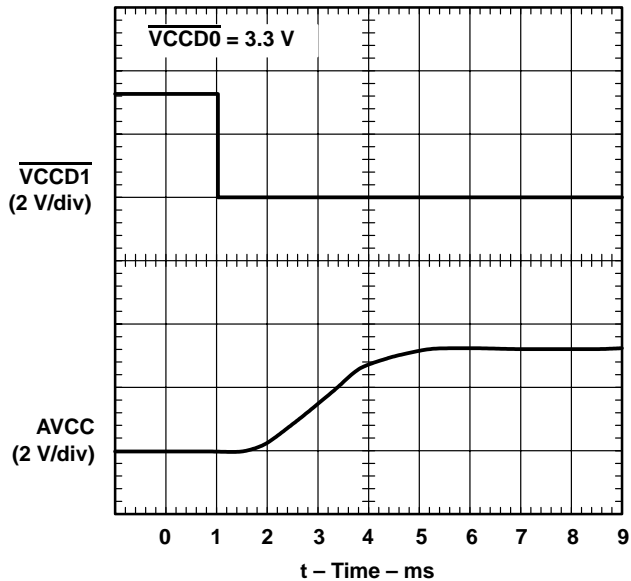

Figure 2. AVCC Propagation Delay and Rise Time With 1- μ F Load, 3.3-V Switch

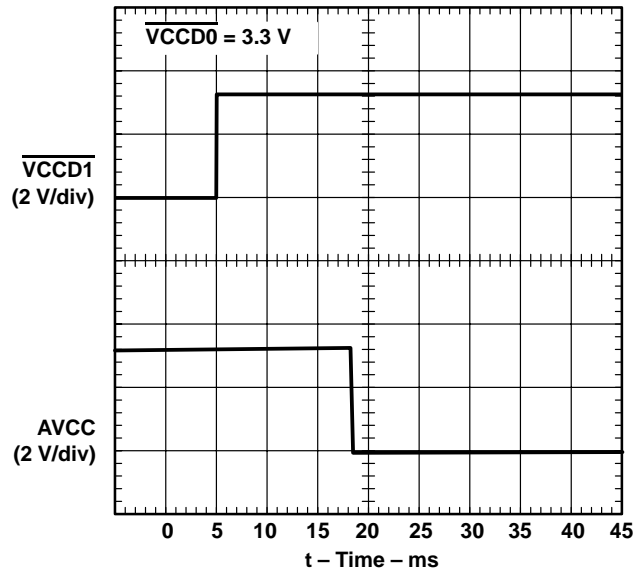

Figure 3. AVCC Propagation Delay and Fall Time With 1- μ F Load, 3.3-V Switch

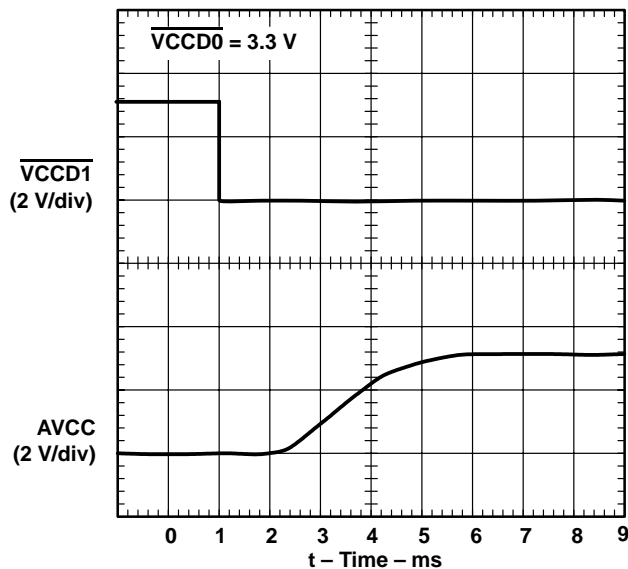

Figure 4. AVCC Propagation Delay and Rise Time With 150- μ F Load, 3.3-V Switch

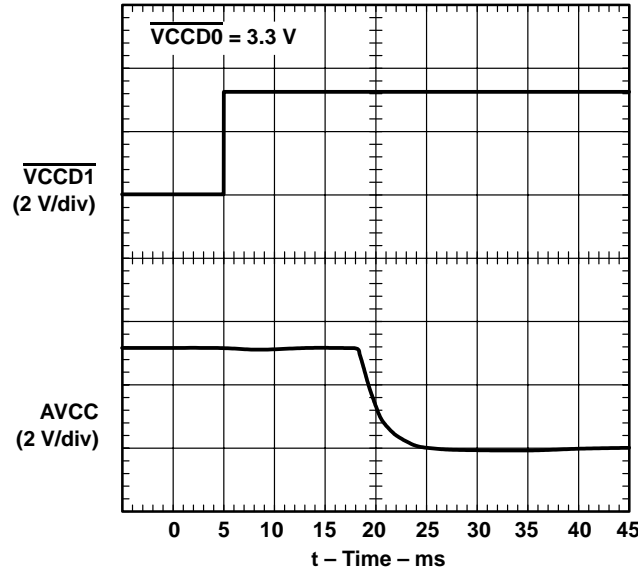

Figure 5. AVCC Propagation Delay and Fall Time With 150- μ F Load, 3.3-V Switch

PARAMETER MEASUREMENT INFORMATION

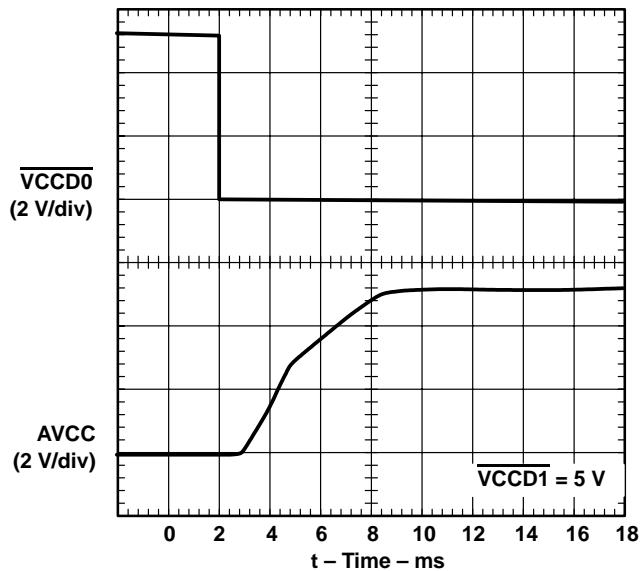

Figure 6. AVCC Propagation Delay and Rise Time With 1- μF Load, 5-V Switch

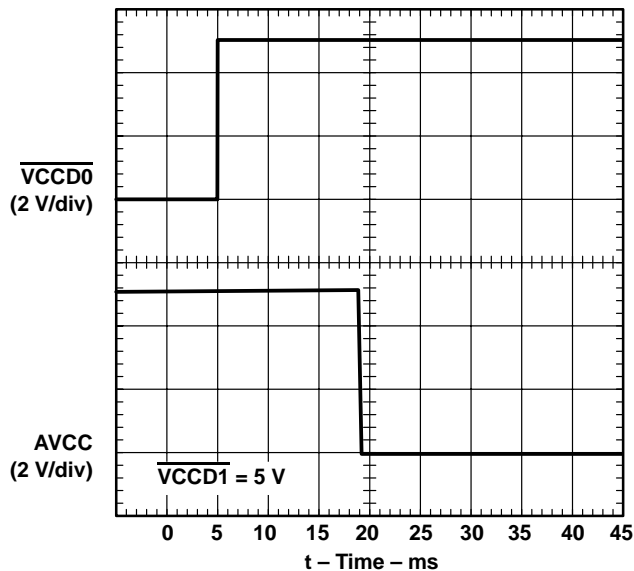

Figure 7. AVCC Propagation Delay and Fall Time With 1- μF Load, 5-V Switch

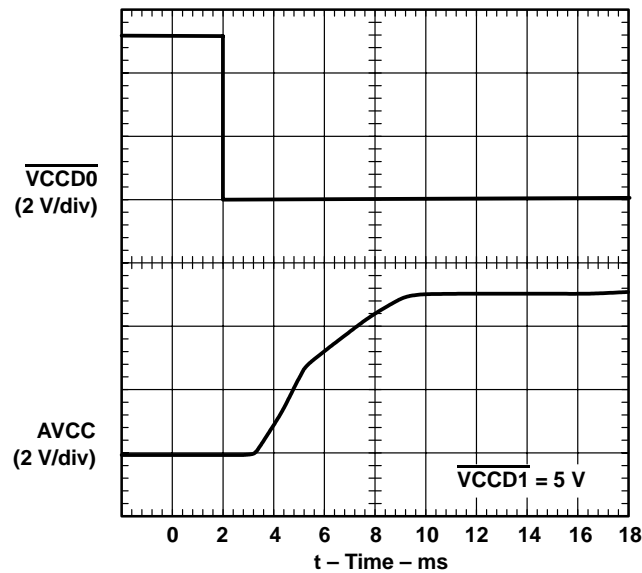

Figure 8. AVCC Propagation Delay and Rise Time With 150- μF Load, 5-V Switch

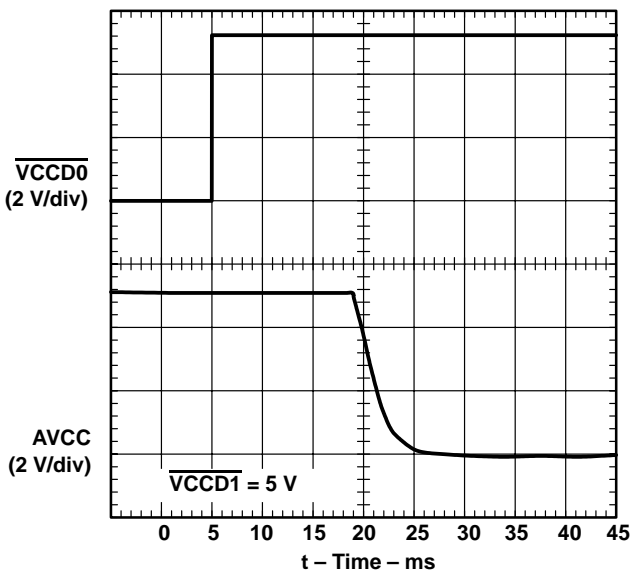

Figure 9. AVCC Propagation Delay and Fall Time With 150- μF Load, 5-V Switch

TPS2211
SINGLE-SLOT PC CARD POWER INTERFACE SWITCH
FOR PARALLEL PCMCIA CONTROLLERS

SLVS156E – JULY 1997 – REVISED JANUARY 2001

PARAMETER MEASUREMENT INFORMATION

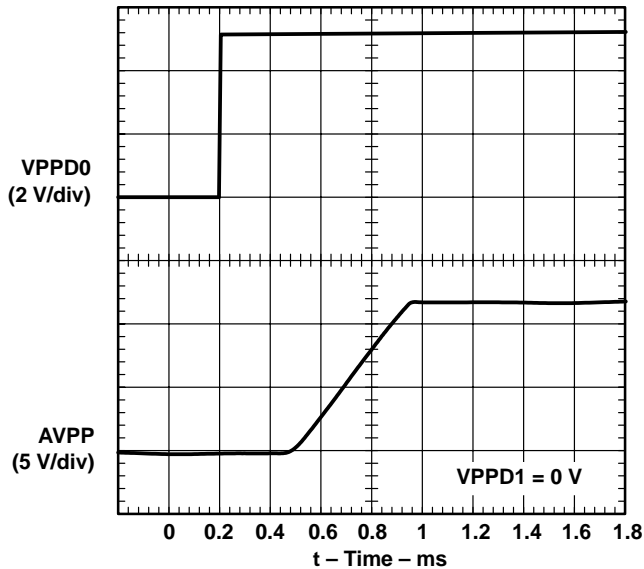

Figure 10. AVPP Propagation Delay and Rise Time With 1- μ F Load, 12-V Switch

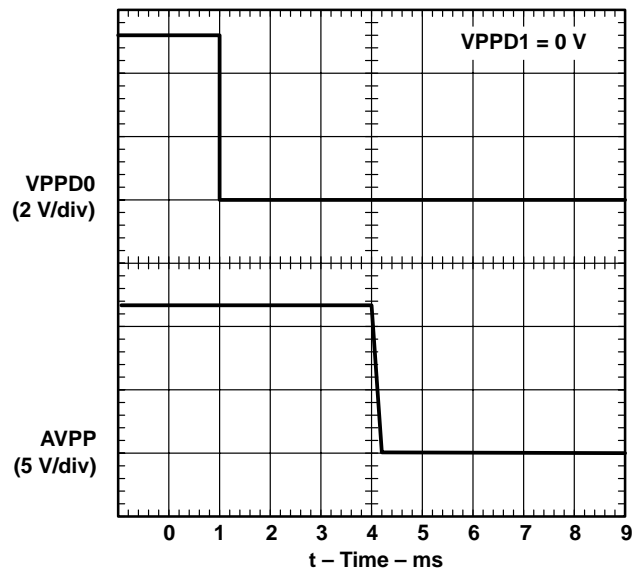

Figure 11. AVPP Propagation Delay and Fall Time With 1- μ F Load, 12-V Switch

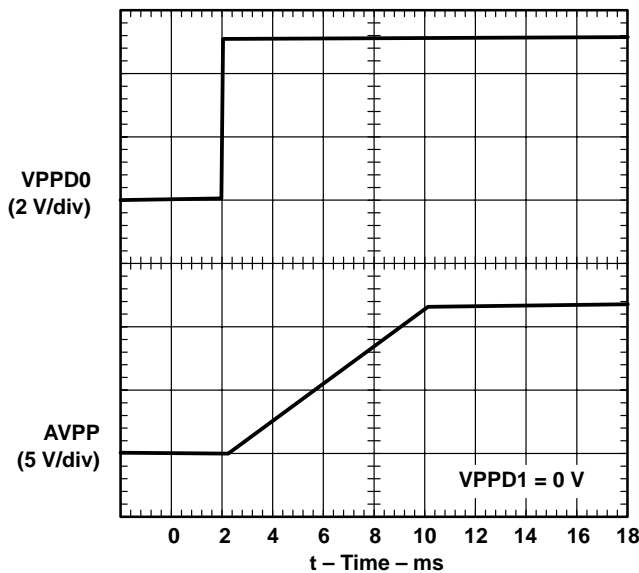

Figure 12. AVPP Propagation Delay and Rise Time With 150- μ F Load, 12-V Switch

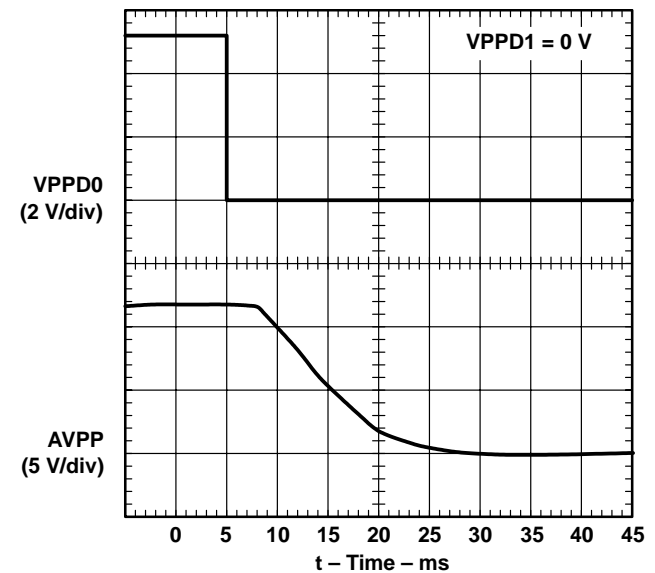

Figure 13. AVPP Propagation Delay and Fall Time With 150- μ F Load, 12-V Switch



TPS2211
SINGLE-SLOT PC CARD POWER INTERFACE SWITCH
FOR PARALLEL PCMCIA CONTROLLERS

SLVS156E – JULY 1997 – REVISED JANUARY 2001

TYPICAL CHARACTERISTICS

Table of Graphs

| | | | FIGURE |
|----------------|---|-------------------------|---------------|
| $I_{CC}(5V)$ | Supply current | vs Junction temperature | 14 |
| $I_{CC}(3.3V)$ | Supply current | vs Junction temperature | 15 |
| $r_{DS(on)}$ | Static drain-source on-state resistance, 5-V VCC switch | vs Junction temperature | 16 |
| $r_{DS(on)}$ | Static drain-source on-state resistance, 3.3-V VCC switch | vs Junction temperature | 17 |
| $r_{DS(on)}$ | Static drain-source on-state resistance, 12-V VPP switch | vs Junction temperature | 18 |
| $V_O(AVCC)$ | Output voltage, 5-V VCC switch | vs Output current | 19 |
| $V_O(AVCC)$ | Output voltage, 3.3-V VCC switch | vs Output current | 20 |
| $V_O(AVPP)$ | Output voltage, 12-V VPP switch | vs Output current | 21 |
| $I_{OS}(AVCC)$ | Short-circuit current, 5-V VCC switch | vs Junction temperature | 22 |
| $I_{OS}(AVCC)$ | Short-circuit current, 3.3-V VCC switch | vs Junction temperature | 23 |
| $I_{OS}(AVPP)$ | Short-circuit current, 12-V VPP switch | vs Junction temperature | 24 |

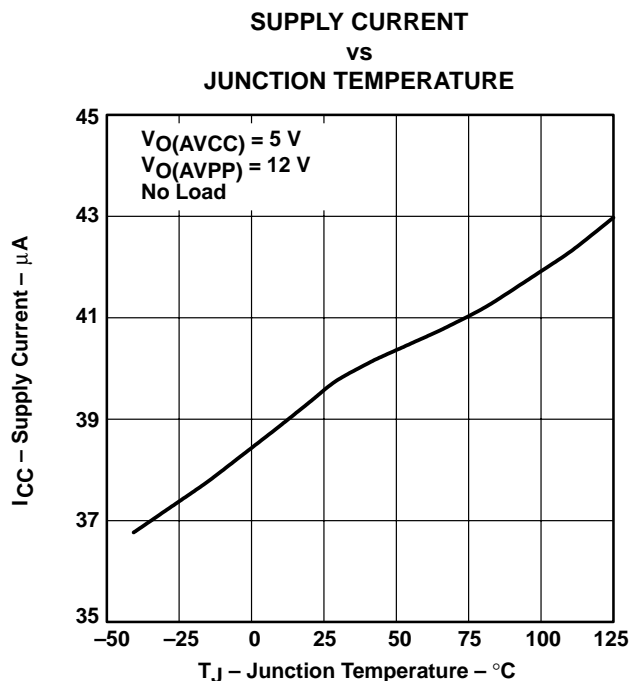

Figure 14

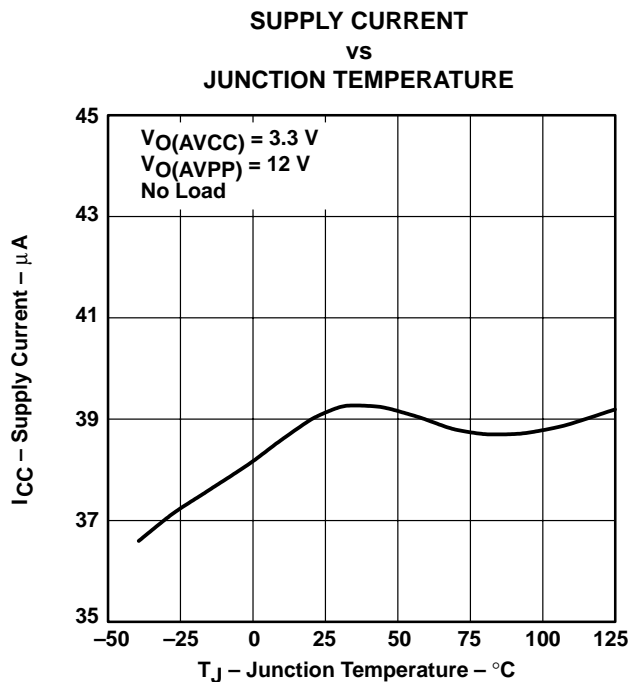

Figure 15

TPS2211
SINGLE-SLOT PC CARD POWER INTERFACE SWITCH
FOR PARALLEL PCMCIA CONTROLLERS

SLVS156E – JULY 1997 – REVISED JANUARY 2001

TYPICAL CHARACTERISTICS

5-V VCC SWITCH
STATIC DRAIN-SOURCE ON-STATE RESISTANCE
vs
JUNCTION TEMPERATURE

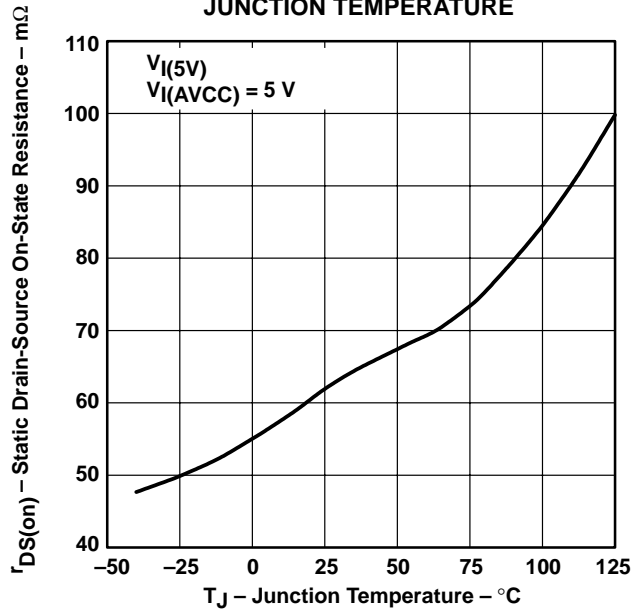

Figure 16

3.3-V VCC SWITCH
STATIC DRAIN-SOURCE ON-STATE RESISTANCE
vs
JUNCTION TEMPERATURE

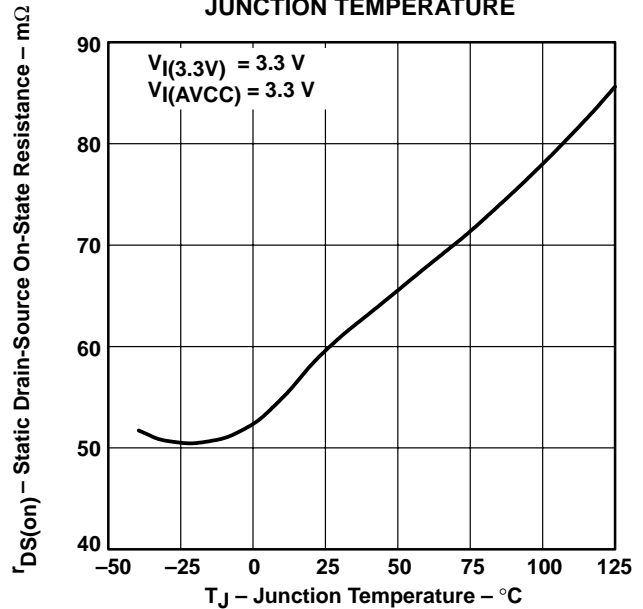

Figure 17

12-V VPP SWITCH
STATIC DRAIN-SOURCE ON-STATE RESISTANCE
vs
JUNCTION TEMPERATURE

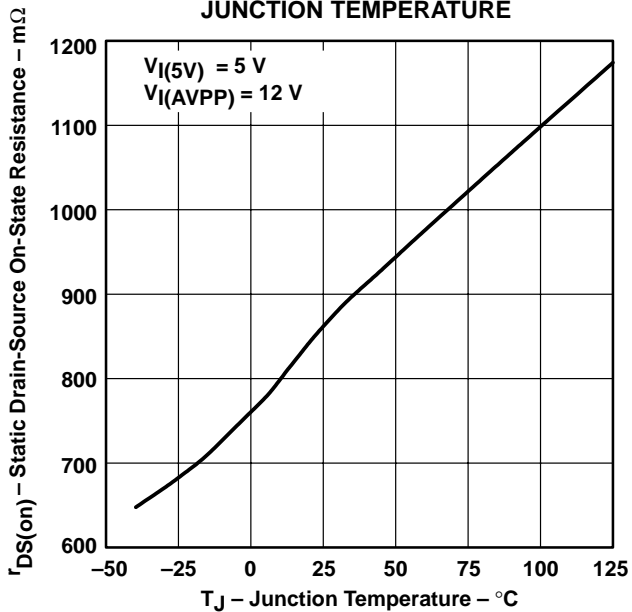

Figure 18

5-V VCC SWITCH
OUTPUT VOLTAGE
vs
OUTPUT CURRENT

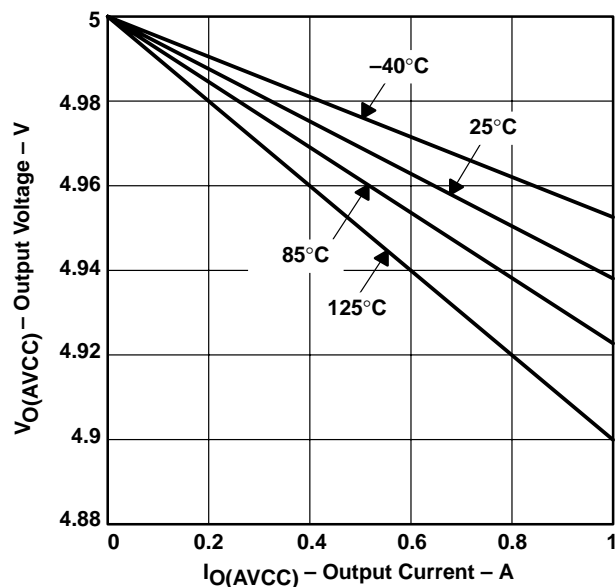

Figure 19



TYPICAL CHARACTERISTICS

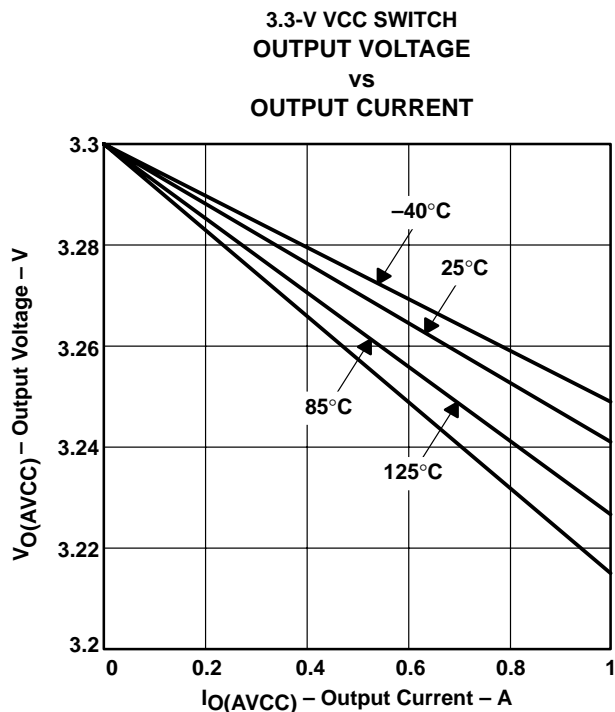

Figure 20

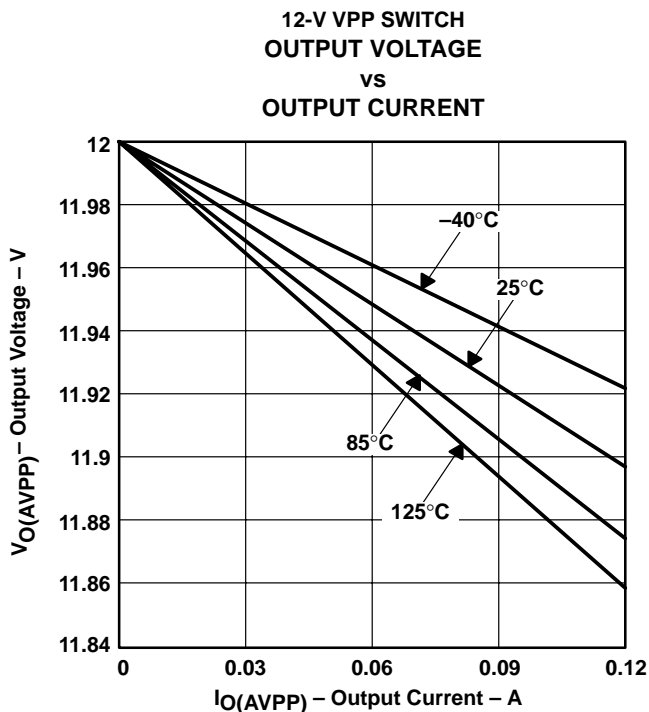

Figure 21

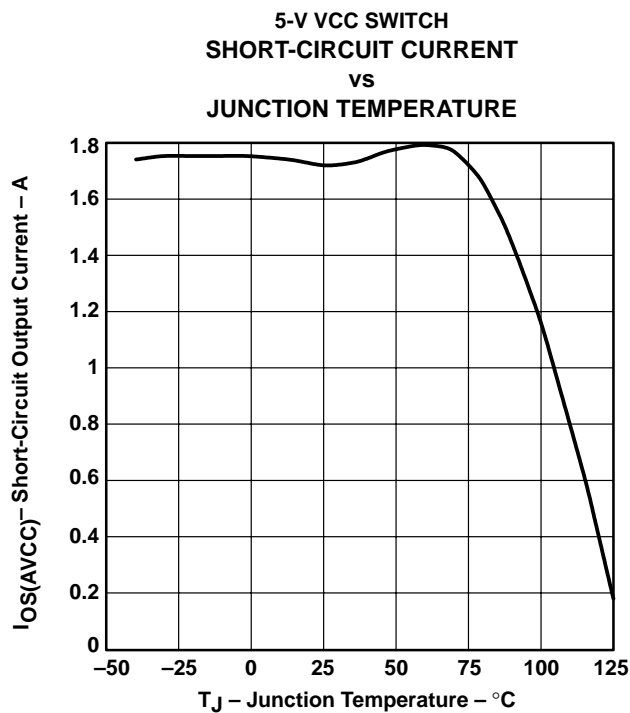

Figure 22

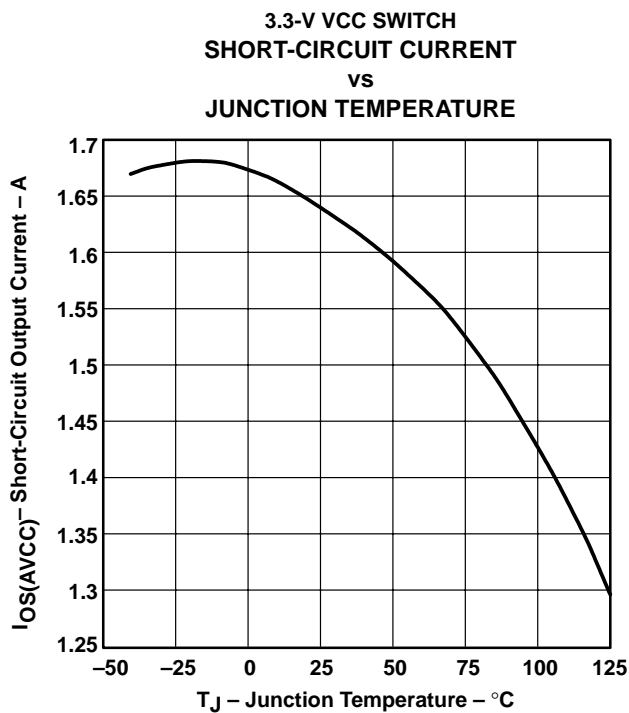

Figure 23

TPS2211 SINGLE-SLOT PC CARD POWER INTERFACE SWITCH FOR PARALLEL PCMCIA CONTROLLERS

SLVS156E – JULY 1997 – REVISED JANUARY 2001

TYPICAL CHARACTERISTICS

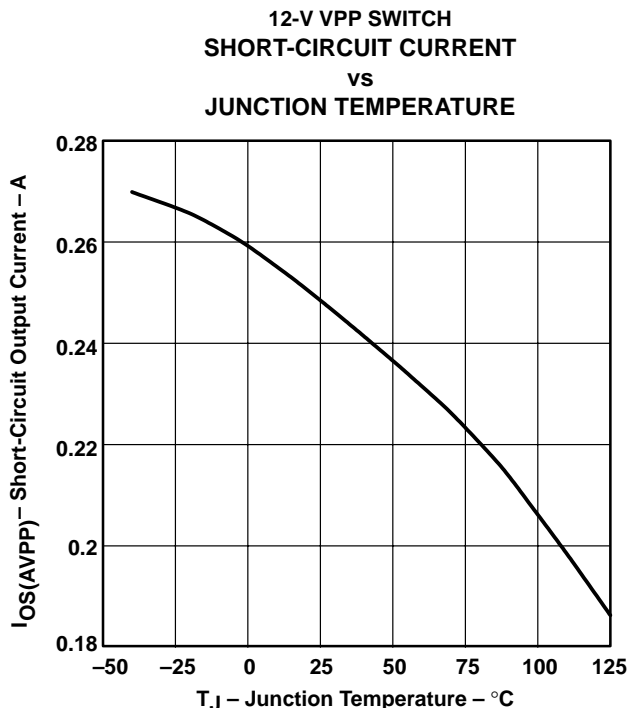

Figure 24

APPLICATION INFORMATION

overview

PC Cards were initially introduced as a means to add EEPROM (flash memory) to portable computers with limited onboard memory. The idea of add-in cards quickly took hold; modems, wireless LANs, GPS systems, multimedia, and hard-disk versions were soon available. As the number of PC Card applications grew, the engineering community quickly recognized the need for a standard to ensure compatibility across platforms. To this end, the PCMCIA (Personal Computer Memory Card International Association) was established, comprised of members from leading computer, software, PC Card, and semiconductor manufacturers. One key goal was to realize the *plug-and-play* concept, i.e. cards and hosts from different vendors should be compatible.

PC Card power specification

System compatibility also means power compatibility. The most current set of specifications (PC Card Standard) set forth by the PCMCIA committee states that power is to be transferred between the host and the card through eight of the 68 terminals of the PC Card connectors. This power interface consists of two V_{CC} , two V_{pp} , and four ground terminals. Multiple V_{CC} and ground terminals minimize connector-terminal and line resistance. The two V_{pp} terminals were originally specified as separate signals but are commonly tied together in the host to form a single node to minimize voltage losses. Card primary power is supplied through the V_{CC} terminals; flash-memory programming and erase voltage is supplied through the V_{pp} terminals.



POST OFFICE BOX 655303 • DALLAS, TEXAS 75265

APPLICATION INFORMATION

designing for voltage regulation

The current PCMCIA specification for output voltage regulation of the 5-V output is 5% (250 mV). In a typical PC power-system design, the power supply will have an output voltage regulation ($V_{PS(\text{reg})}$) of 2% (100 mV). Also, a voltage drop from the power supply to the PC Card will result from resistive losses (V_{PCB}) in the PCB traces and the PCMCIA connector. A typical design would limit the total of these resistive losses to less than 1% (50 mV) of the output voltage. Therefore, the allowable voltage drop (V_{DS}) for the TPS2211 is the PCMCIA voltage regulation less the power supply regulation and less the PCB and connector resistive drops:

$$V_{DS} = V_{O(\text{reg})} - V_{PS(\text{reg})} - V_{PCB}$$

Typically, this would leave 100 mV for the allowable voltage drop across the TPS2211. The voltage drop is the output current multiplied by the switch resistance of the TPS2211. Therefore, the maximum output current that can be delivered to the PC Card in regulation is the allowable voltage drop across the TPS2211 divided by the output switch resistance.

$$I_{O\text{max}} = \frac{V_{DS}}{r_{DS(\text{on})}}$$

The AVCC outputs deliver 1 A continuous at 5 V and 3.3 V within regulation over the operating temperature range. Using the same equations, the PCMCIA specification for output voltage regulation of the 3.3-V output is 300 mV. Using the voltage drop percentages for power supply regulation (2%) and PCB resistive loss (1%), the allowable voltage drop for the 3.3-V switch is 200 mV. The 12-V outputs (AVPP) of the TPS2211 can deliver 150 mA continuously.

overcurrent and overtemperature protection

PC Cards are inherently subject to damage from mishandling. Host systems require protection against short-circuited cards that could lead to power supply or PCB trace damage. Even systems sufficiently robust to withstand a short circuit would still undergo rapid battery discharge into the damaged PC Card, resulting in a sudden loss of system power. Most hosts include fuses for protection. The reliability of fused systems is poor and requires troubleshooting and repair, usually by the manufacturer, when fuses are blown.

The TPS2211 uses sense FETs to check for overcurrent conditions in each of the AVCC and AVPP outputs. Unlike sense resistors or polyfuses, these FETs do not add to the series resistance of the switch; therefore voltage and power losses are reduced. Overcurrent sensing is applied to each output separately. When an overcurrent condition is detected, only the power output affected is limited; all other power outputs continue to function normally. The \overline{OC} indicator, normally a logic high, is a logic low when an overcurrent condition is detected providing for initiation of system diagnostics and/or sending a warning message to the user.

During power up, the TPS2211 controls the rise time of the AVCC and AVPP outputs and limits the current into a faulty card or connector. If a short circuit is applied after power is established (e.g., hot insertion of a bad card), current is initially limited only by the impedance between the short and the power supply. In extreme cases, as much as 10 A to 15 A may flow into the short before the current limiting of the TPS2211 engages. If the AVCC or AVPP outputs are driven below ground, the TPS2211 may latch nondestructively in an off state. Cycling power will reestablish normal operation.

Overcurrent limiting for the AVCC outputs is designed to activate if powered up into a short in the range of 1 A to 2.2 A, typically at about 1.6 A. The AVPP outputs limit from 120 mA to 400 mA, typically around 280 mA. The protection circuitry acts by linearly limiting the current passing through the switch rather than initiating a full shutdown of the supply. Shutdown occurs only during thermal limiting.

Thermal limiting prevents destruction of the IC from overheating if the package power dissipation ratings are exceeded. Thermal limiting disables power output until the device has cooled.

TPS2211

SINGLE-SLOT PC CARD POWER INTERFACE SWITCH FOR PARALLEL PCMCIA CONTROLLERS

SLVS156E – JULY 1997 – REVISED JANUARY 2001

APPLICATION INFORMATION

12-V supply not required

Most PC Card switches use the externally supplied 12 V to power gate drive and other chip functions, which require that power be present at all times. The TPS2211 offers considerable power savings by using an internal charge pump to generate the required higher voltages from the 5-V input. Therefore, the external 12-V supply can be disabled except when needed for flash-memory functions, thereby extending battery lifetime. Do not ground the 12-V switch inputs when the 12-V input is not used. Additional power savings are realized by the TPS2211 during a software shutdown in which quiescent current drops to a maximum of 1 μ A.

3.3-V low-voltage mode

The TPS2211 will operate in a 3.3-V low-voltage mode when 3.3 V is the only available input voltage ($V_{I(5V)} = 0$). This allows host and PC Cards to be operated in low-power 3.3-volts-only modes such as sleep or pager modes. Note that in these operation modes, the TPS2211 will derive its bias current from the 3.3-V input pin and only 3.3 V can be delivered to the PC Card.

voltage transitioning requirement

PC Cards are migrating from 5 V to 3.3 V to minimize power consumption, optimize board space, and increase logic speeds. The TPS2211 meets all combinations of power delivery as currently defined in the PCMCIA standard. The latest protocol accommodates mixed 3.3-V/5-V systems by first powering the card with 5 V, then polling it to determine its 3.3-V compatibility. The PCMCIA specification requires that the capacitors on 3.3-V compatible cards be discharged to below 0.8 V before applying 3.3-V power. This functions as a power reset and ensures that sensitive 3.3-V circuitry is not subjected to any residual 5-V charge. The TPS2211 offers a selectable V_{CC} and V_{pp} ground state, in accordance with PCMCIA 3.3-V/5-V switching specifications.

output ground switches

PC Card specification requires that V_{CC} be discharged within 100 ms. PC Card resistance can not be relied on to provide a discharge path for voltages stored on PC Card capacitance because of possible high-impedance isolation by power-management schemes.

power-supply considerations

The TPS2211 has multiple pins for each of its 3.3-V and 5-V power inputs and for the switched AVCC outputs. Any individual pin can conduct the rated input or output current. Unless all pins are connected in parallel, the series resistance is significantly higher than that specified, resulting in increased voltage drops and lost power. It is recommended that all input and output power pins be paralleled for optimum operation.

To increase the noise immunity of the TPS2211, the power supply inputs should be bypassed with a 1- μ F electrolytic or tantalum capacitor paralleled by a 0.047- μ F to 0.1- μ F ceramic capacitor. It is strongly recommended that the switched outputs be bypassed with a 0.1- μ F, or larger, ceramic capacitor; doing so improves the immunity of the TPS2211 to electrostatic discharge (ESD). Care should be taken to minimize the inductance of PCB traces between the TPS2211 and the load. High switching currents can produce large negative voltage transients, which forward biases substrate diodes, resulting in unpredictable performance. Similarly, no pin should be taken below -0.3 V.



POST OFFICE BOX 655303 • DALLAS, TEXAS 75265

APPLICATION INFORMATION

calculating junction temperature

The switch resistance, $r_{DS(on)}$, is dependent on the junction temperature, T_J , of the die and the current through the switch. To calculate T_J , first find $r_{DS(on)}$ from Figures 16 through 18 using an initial temperature estimate about 50°C above ambient. Then calculate the power dissipation for each switch, using the formula:

$$P_D = r_{DS(on)} \times I^2$$

Next, sum the power dissipation and calculate the junction temperature:

$$T_J = \left(\sum P_D \times R_{\theta JA} \right) + T_A, \quad R_{\theta JA} = 108^\circ\text{C/W}$$

Compare the calculated junction temperature with the initial temperature estimate. If the temperatures are not within a few degrees of each other, recalculate using the calculated temperature as the initial estimate.

ESD protection

All TPS2211 inputs and outputs incorporate ESD-protection circuitry designed to withstand a 2-kV human-body-model discharge as defined in MIL-STD-883C, Method 3015. The AVCC and AVPP outputs can be exposed to potentially higher discharges from the external environment through the PC Card connector. Bypassing the outputs with 0.1- μF capacitors protects the devices from discharges up to 10 kV.

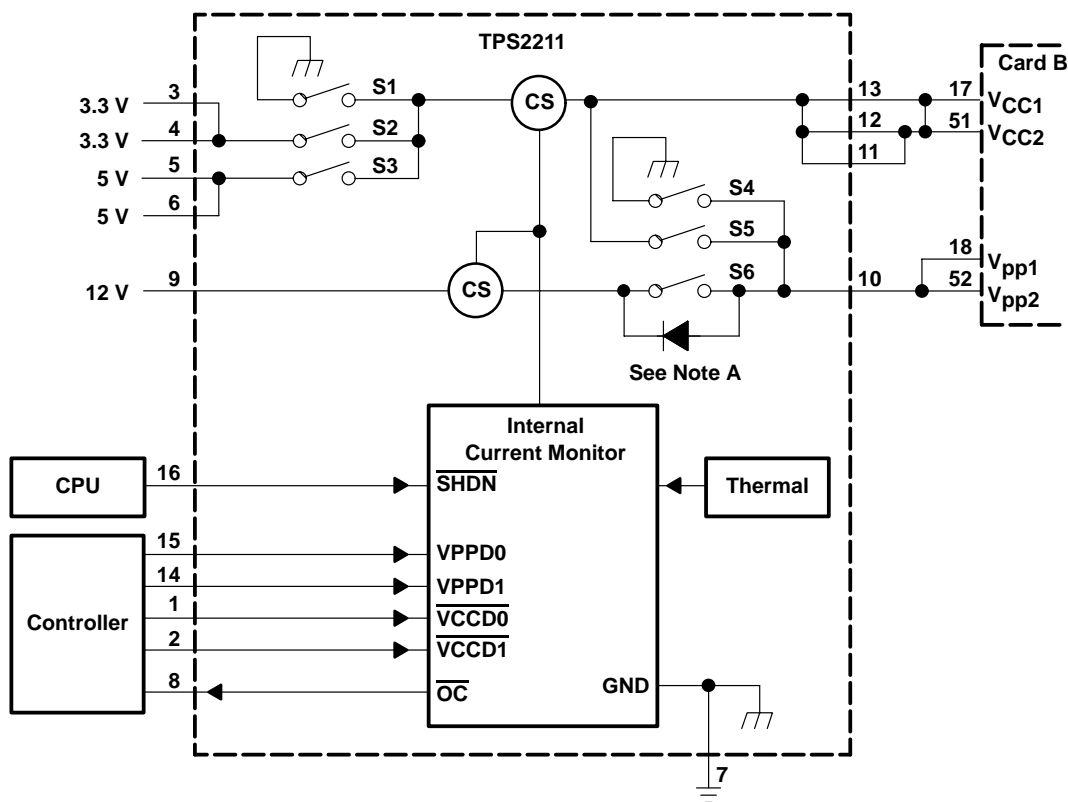

NOTE A: MOSFET switch S6 has a back-gate diode from the source to the drain. Unused switch inputs should never be grounded.

Figure 25. Internal Switching Matrix, TPS2211 Control Logic

TPS2211
SINGLE-SLOT PC CARD POWER INTERFACE SWITCH
FOR PARALLEL PCMCIA CONTROLLERS

SLVS156E – JULY 1997 – REVISED JANUARY 2001

APPLICATION INFORMATION

TPS2211 control logic

AVPP

| CONTROL SIGNALS | | | INTERNAL SWITCH SETTINGS | | | OUTPUT |
|--------------------------|-------|-------|--------------------------|--------|--------|------------|
| $\overline{\text{SHDN}}$ | VPPD0 | VPPD1 | S4 | S5 | S6 | AVPP |
| 1 | 0 | 0 | CLOSED | OPEN | OPEN | 0 V |
| 1 | 0 | 1 | OPEN | CLOSED | OPEN | AVCC† |
| 1 | 1 | 0 | OPEN | OPEN | CLOSED | VPP (12 V) |
| 1 | 1 | 1 | OPEN | OPEN | OPEN | Hi-Z |
| 0 | X | X | OPEN | OPEN | OPEN | Hi-Z |

† Output depends on AVCC

AVCC

| CONTROL SIGNALS | | | INTERNAL SWITCH SETTINGS | | | OUTPUT |
|--------------------------|---------------------------|---------------------------|--------------------------|--------|--------|--------|
| $\overline{\text{SHDN}}$ | $\overline{\text{VCCD1}}$ | $\overline{\text{VCCD0}}$ | S1 | S2 | S3 | AVCC |
| 1 | 0 | 0 | CLOSED | OPEN | OPEN | 0 V |
| 1 | 0 | 1 | OPEN | CLOSED | OPEN | 3.3 V |
| 1 | 1 | 0 | OPEN | OPEN | CLOSED | 5 V |
| 1 | 1 | 1 | CLOSED | OPEN | OPEN | 0 V |
| 0 | X | X | OPEN | OPEN | OPEN | Hi-Z |

12-V flash memory supply

The TPS6734 is a fixed 12-V output boost converter capable of delivering 120 mA from inputs as low as 2.7 V. The device is pin-for-pin compatible with the MAX734 regulator and offers the following advantages: lower supply current, wider operating input-voltage range, and higher output currents. As shown in Figure 1, the only external components required are: an inductor, a Schottky rectifier, an output filter capacitor, an input filter capacitor, and a small capacitor for loop compensation. The entire converter occupies less than 0.7 in² of PCB space when implemented with surface-mount components. An enable input is provided to shut the converter down and reduce the supply current to 3 μ A when 12 V is not needed.

The TPS6734 is a 170-kHz current-mode PWM (pulse-width modulation) controller with an n-channel MOSFET power switch. Gate drive for the switch is derived from the 12-V output after start-up to minimize the die area needed to realize the 0.7- Ω MOSFET and improve efficiency at input voltages below 5 V. Soft start is accomplished with the addition of one small capacitor. A 1.22-V reference (pin 2) is brought out for external use. For additional information, see the TPS6734 data sheet (SLVS127).



TPS2211
SINGLE-SLOT PC CARD POWER INTERFACE SWITCH
FOR PARALLEL PCMCIA CONTROLLERS

SLVS156E – JULY 1997 – REVISED JANUARY 2001

APPLICATION INFORMATION

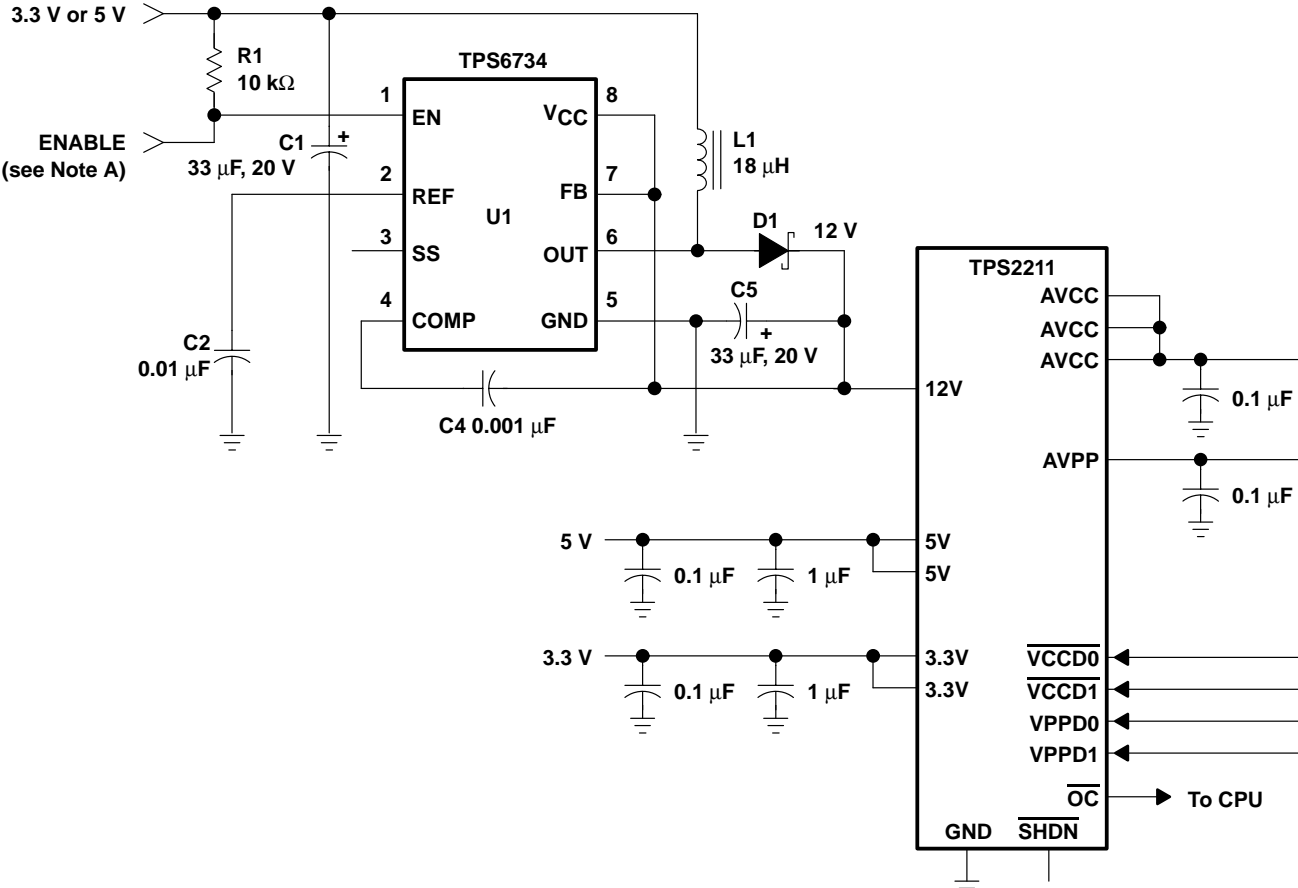

NOTE A: The enable terminal can be tied to a general-purpose I/O terminal on the PCMCIA controller or tied high.

Figure 26. TPS2211 With TPS6734 12-V, 120-mA Supply



PACKAGING INFORMATION

| Orderable Device | Status (1) | Package Type | Package Drawing | Pins | Package Qty | Eco Plan (2) | Lead/Ball Finish (6) | MSL Peak Temp (3) | Op Temp (°C) | Device Marking (4/5) | Samples |
|------------------|---------------|--------------|-----------------|------|-------------|-------------------------|-------------------------|----------------------|--------------|-------------------------|-------------------------|
| TPS2211IDB | ACTIVE | SSOP | DB | 16 | 80 | Green (RoHS & no Sb/Br) | CU NIPDAU | Level-1-260C-UNLIM | | PU2211 | Samples |
| TPS2211IDBG4 | ACTIVE | SSOP | DB | 16 | 80 | Green (RoHS & no Sb/Br) | CU NIPDAU | Level-1-260C-UNLIM | | PU2211 | Samples |
| TPS2211IDBR | ACTIVE | SSOP | DB | 16 | 2000 | Green (RoHS & no Sb/Br) | CU NIPDAU | Level-1-260C-UNLIM | -40 to 85 | PU2211 | Samples |

(1) The marketing status values are defined as follows:

ACTIVE: Product device recommended for new designs.

LIFEBUY: TI has announced that the device will be discontinued, and a lifetime-buy period is in effect.

NRND: Not recommended for new designs. Device is in production to support existing customers, but TI does not recommend using this part in a new design.

PREVIEW: Device has been announced but is not in production. Samples may or may not be available.

OBsolete: TI has discontinued the production of the device.

(2) **RoHS:** TI defines "RoHS" to mean semiconductor products that are compliant with the current EU RoHS requirements for all 10 RoHS substances, including the requirement that RoHS substance do not exceed 0.1% by weight in homogeneous materials. Where designed to be soldered at high temperatures, "RoHS" products are suitable for use in specified lead-free processes. TI may reference these types of products as "Pb-Free".

RoHS Exempt: TI defines "RoHS Exempt" to mean products that contain lead but are compliant with EU RoHS pursuant to a specific EU RoHS exemption.

Green: TI defines "Green" to mean the content of Chlorine (Cl) and Bromine (Br) based flame retardants meet JS709B low halogen requirements of <=1000ppm threshold. Antimony trioxide based flame retardants must also meet the <=1000ppm threshold requirement.

(3) MSL, Peak Temp. - The Moisture Sensitivity Level rating according to the JEDEC industry standard classifications, and peak solder temperature.

(4) There may be additional marking, which relates to the logo, the lot trace code information, or the environmental category on the device.

(5) Multiple Device Markings will be inside parentheses. Only one Device Marking contained in parentheses and separated by a "-" will appear on a device. If a line is indented then it is a continuation of the previous line and the two combined represent the entire Device Marking for that device.

(6) Lead/Ball Finish - Orderable Devices may have multiple material finish options. Finish options are separated by a vertical ruled line. Lead/Ball Finish values may wrap to two lines if the finish value exceeds the maximum column width.

Important Information and Disclaimer:The information provided on this page represents TI's knowledge and belief as of the date that it is provided. TI bases its knowledge and belief on information provided by third parties, and makes no representation or warranty as to the accuracy of such information. Efforts are underway to better integrate information from third parties. TI has taken and continues to take reasonable steps to provide representative and accurate information but may not have conducted destructive testing or chemical analysis on incoming materials and chemicals. TI and TI suppliers consider certain information to be proprietary, and thus CAS numbers and other limited information may not be available for release.

In no event shall TI's liability arising out of such information exceed the total purchase price of the TI part(s) at issue in this document sold by TI to Customer on an annual basis.

TAPE AND REEL INFORMATION

REEL DIMENSIONS



TAPE DIMENSIONS



| | |
|----|---|
| A0 | Dimension designed to accommodate the component width |
| B0 | Dimension designed to accommodate the component length |
| K0 | Dimension designed to accommodate the component thickness |
| W | Overall width of the carrier tape |
| P1 | Pitch between successive cavity centers |

TAPE AND REEL INFORMATION

*All dimensions are nominal

| Device | Package Type | Package Drawing | Pins | SPQ | Reel Diameter (mm) | Reel Width W1 (mm) | A0 (mm) | B0 (mm) | K0 (mm) | P1 (mm) | W (mm) | Pin1 Quadrant |
|-------------|--------------|-----------------|------|------|--------------------|--------------------|---------|---------|---------|---------|--------|---------------|
| TPS2211IDBR | SSOP | DB | 16 | 2000 | 330.0 | 16.4 | 8.2 | 6.6 | 2.5 | 12.0 | 16.0 | Q1 |

TAPE AND REEL BOX DIMENSIONS



*All dimensions are nominal

| Device | Package Type | Package Drawing | Pins | SPQ | Length (mm) | Width (mm) | Height (mm) |
|-------------|--------------|-----------------|------|------|-------------|------------|-------------|
| TPS2211IDBR | SSOP | DB | 16 | 2000 | 367.0 | 367.0 | 38.0 |

IMPORTANT NOTICE

Texas Instruments Incorporated (TI) reserves the right to make corrections, enhancements, improvements and other changes to its semiconductor products and services per JESD46, latest issue, and to discontinue any product or service per JESD48, latest issue. Buyers should obtain the latest relevant information before placing orders and should verify that such information is current and complete.

TI's published terms of sale for semiconductor products (<http://www.ti.com/sc/docs/stdterms.htm>) apply to the sale of packaged integrated circuit products that TI has qualified and released to market. Additional terms may apply to the use or sale of other types of TI products and services.

Reproduction of significant portions of TI information in TI data sheets is permissible only if reproduction is without alteration and is accompanied by all associated warranties, conditions, limitations, and notices. TI is not responsible or liable for such reproduced documentation. Information of third parties may be subject to additional restrictions. Resale of TI products or services with statements different from or beyond the parameters stated by TI for that product or service voids all express and any implied warranties for the associated TI product or service and is an unfair and deceptive business practice. TI is not responsible or liable for any such statements.

Buyers and others who are developing systems that incorporate TI products (collectively, "Designers") understand and agree that Designers remain responsible for using their independent analysis, evaluation and judgment in designing their applications and that Designers have full and exclusive responsibility to assure the safety of Designers' applications and compliance of their applications (and of all TI products used in or for Designers' applications) with all applicable regulations, laws and other applicable requirements. Designer represents that, with respect to their applications, Designer has all the necessary expertise to create and implement safeguards that (1) anticipate dangerous consequences of failures, (2) monitor failures and their consequences, and (3) lessen the likelihood of failures that might cause harm and take appropriate actions. Designer agrees that prior to using or distributing any applications that include TI products, Designer will thoroughly test such applications and the functionality of such TI products as used in such applications.

TI's provision of technical, application or other design advice, quality characterization, reliability data or other services or information, including, but not limited to, reference designs and materials relating to evaluation modules, (collectively, "TI Resources") are intended to assist designers who are developing applications that incorporate TI products; by downloading, accessing or using TI Resources in any way, Designer (individually or, if Designer is acting on behalf of a company, Designer's company) agrees to use any particular TI Resource solely for this purpose and subject to the terms of this Notice.

TI's provision of TI Resources does not expand or otherwise alter TI's applicable published warranties or warranty disclaimers for TI products, and no additional obligations or liabilities arise from TI providing such TI Resources. TI reserves the right to make corrections, enhancements, improvements and other changes to its TI Resources. TI has not conducted any testing other than that specifically described in the published documentation for a particular TI Resource.

Designer is authorized to use, copy and modify any individual TI Resource only in connection with the development of applications that include the TI product(s) identified in such TI Resource. NO OTHER LICENSE, EXPRESS OR IMPLIED, BY ESTOPPEL OR OTHERWISE TO ANY OTHER TI INTELLECTUAL PROPERTY RIGHT, AND NO LICENSE TO ANY TECHNOLOGY OR INTELLECTUAL PROPERTY RIGHT OF TI OR ANY THIRD PARTY IS GRANTED HEREIN, including but not limited to any patent right, copyright, mask work right, or other intellectual property right relating to any combination, machine, or process in which TI products or services are used. Information regarding or referencing third-party products or services does not constitute a license to use such products or services, or a warranty or endorsement thereof. Use of TI Resources may require a license from a third party under the patents or other intellectual property of the third party, or a license from TI under the patents or other intellectual property of TI.

TI RESOURCES ARE PROVIDED "AS IS" AND WITH ALL FAULTS. TI DISCLAIMS ALL OTHER WARRANTIES OR REPRESENTATIONS, EXPRESS OR IMPLIED, REGARDING RESOURCES OR USE THEREOF, INCLUDING BUT NOT LIMITED TO ACCURACY OR COMPLETENESS, TITLE, ANY EPIDEMIC FAILURE WARRANTY AND ANY IMPLIED WARRANTIES OF MERCHANTABILITY, FITNESS FOR A PARTICULAR PURPOSE, AND NON-INFRINGEMENT OF ANY THIRD PARTY INTELLECTUAL PROPERTY RIGHTS. TI SHALL NOT BE LIABLE FOR AND SHALL NOT DEFEND OR INDEMNIFY DESIGNER AGAINST ANY CLAIM, INCLUDING BUT NOT LIMITED TO ANY INFRINGEMENT CLAIM THAT RELATES TO OR IS BASED ON ANY COMBINATION OF PRODUCTS EVEN IF DESCRIBED IN TI RESOURCES OR OTHERWISE. IN NO EVENT SHALL TI BE LIABLE FOR ANY ACTUAL, DIRECT, SPECIAL, COLLATERAL, INDIRECT, PUNITIVE, INCIDENTAL, CONSEQUENTIAL OR EXEMPLARY DAMAGES IN CONNECTION WITH OR ARISING OUT OF TI RESOURCES OR USE THEREOF, AND REGARDLESS OF WHETHER TI HAS BEEN ADVISED OF THE POSSIBILITY OF SUCH DAMAGES.

Unless TI has explicitly designated an individual product as meeting the requirements of a particular industry standard (e.g., ISO/TS 16949 and ISO 26262), TI is not responsible for any failure to meet such industry standard requirements.

Where TI specifically promotes products as facilitating functional safety or as compliant with industry functional safety standards, such products are intended to help enable customers to design and create their own applications that meet applicable functional safety standards and requirements. Using products in an application does not by itself establish any safety features in the application. Designers must ensure compliance with safety-related requirements and standards applicable to their applications. Designer may not use any TI products in life-critical medical equipment unless authorized officers of the parties have executed a special contract specifically governing such use. Life-critical medical equipment is medical equipment where failure of such equipment would cause serious bodily injury or death (e.g., life support, pacemakers, defibrillators, heart pumps, neurostimulators, and implantables). Such equipment includes, without limitation, all medical devices identified by the U.S. Food and Drug Administration as Class III devices and equivalent classifications outside the U.S.

TI may expressly designate certain products as completing a particular qualification (e.g., Q100, Military Grade, or Enhanced Product). Designers agree that it has the necessary expertise to select the product with the appropriate qualification designation for their applications and that proper product selection is at Designers' own risk. Designers are solely responsible for compliance with all legal and regulatory requirements in connection with such selection.

Designer will fully indemnify TI and its representatives against any damages, costs, losses, and/or liabilities arising out of Designer's non-compliance with the terms and provisions of this Notice.