

## Description

The  $\mu$ PD41464 is a 65,536-word by 4-bit dynamic RAM designed to operate from a single +5-volt power supply and fabricated with a double polylayer, N-channel silicon-gate process for high density, high performance, and high reliability. A single-transistor storage cell and advanced dynamic circuitry ensure minimum power dissipation, while an on-chip feature internally generates the negative voltage substrate bias—automatically and transparently.

The three-state I/O is controlled by  $\overline{\text{CAS}}$  independent of  $\overline{\text{RAS}}$ . After a valid read or hidden refresh cycle, data is held by holding  $\overline{\text{CAS}}$  low. Data input and output is returned to high impedance by returning  $\overline{\text{CAS}}$  high. Hidden refreshing allows  $\overline{\text{CAS}}$  to be held low to maintain output data while  $\overline{\text{RAS}}$  is used to execute  $\overline{\text{RAS}}$ -only refresh cycles.

Refreshing may be accomplished by means of a  $\overline{\text{CAS}}$  before  $\overline{\text{RAS}}$  cycle that internally generates the refresh address, by means of  $\overline{\text{RAS}}$ -only refresh cycles, or by normal read or write cycles on the 256 address combinations of  $A_0$  through  $A_7$  during a 4-ms refresh period.

## Features

- 65,536-word by 4-bit organization
- Single +5-volt  $\pm 10\%$  power supply
- $\overline{\text{CAS}}$  before  $\overline{\text{RAS}}$  internal refreshing
- Multiplexed address inputs
- On-chip substrate bias generator
- Low power dissipation
  - 28 mA max (standby)
  - 440 mW (active,  $t_{\text{RC}} = t_{\text{RC min}}$ )
- Nonlatched, TTL-compatible inputs and outputs
- Low input capacitance
- 256 refresh cycles every 4 ms
- Standard 18-pin plastic DIP and PLCC packaging

## Ordering Information

Part Number	Row Access Time (max)	Package
$\mu$ PD41464C-80	80 ns	18-pin plastic DIP
C-10	100 ns	
C-12	120 ns	
$\mu$ PD41464L-80	80 ns	18-pin PLCC
L-10	100 ns	
L-12	120 ns	

## Pin Configurations

### 18-Pin Plastic DIP

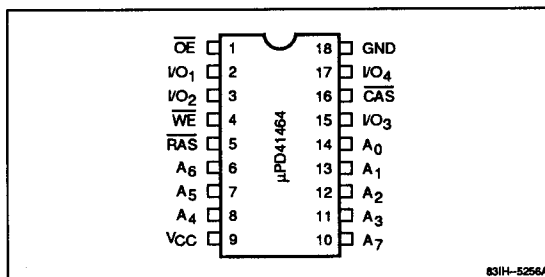

### 18-Pin Plastic Leaded Chip Carrier (PLCC)

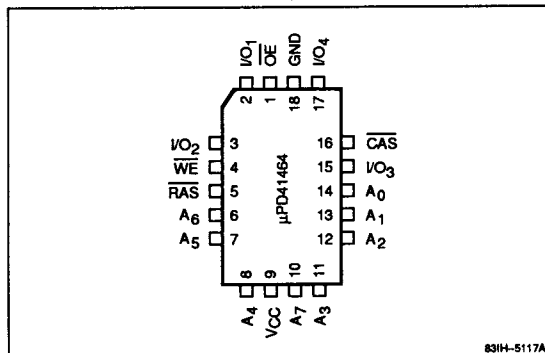

3b

**Pin Identification**

Name	Function
A <sub>0</sub> - A <sub>7</sub>	Address inputs
I/O <sub>1</sub> - I/O <sub>4</sub>	Data inputs and outputs
CAS	Column address strobe
OE	Output enable
RAS	Row address strobe
WE	Write enable
GND	Ground
V <sub>CC</sub>	+5-volt power supply
NC	No connection

**Capacitance**

T<sub>A</sub> = 25°C; f = 1 MHz

Parameter	Symbol	Max	Unit	Pins Under Test
Input capacitance	C <sub>I1</sub>	5	pF	A <sub>0</sub> through A <sub>7</sub>
	C <sub>I2</sub>	8	pF	RAS, CAS, WE, OE
Input/output capacitance	C <sub>O</sub>	7	pF	I/O <sub>1</sub> through I/O <sub>4</sub>

**Absolute Maximum Ratings**

Voltage on any pin relative to GND	-1.0 to +7.0 V
Operating temperature, T <sub>OPR</sub>	0 to +70°C
Storage temperature, T <sub>STG</sub>	-55 to +125°C
Short-circuit output current, I <sub>OS</sub>	50 mA
Power dissipation, P <sub>D</sub>	1.0 W

Exposure to Absolute Maximum Ratings for extended periods may affect device reliability; exceeding the ratings could cause permanent damage. The device should be operated within the limits specified under DC and AC Characteristics.

**Recommended Operating Conditions**

Parameter	Symbol	Min	Typ	Max	Unit
Input voltage, high	V <sub>IH</sub>	2.4		V <sub>CC</sub> + 1	V
Input voltage, low	V <sub>IL</sub>	-1		0.8	V
Supply voltage	V <sub>CC</sub>	4.5	5.0	5.5	V
Ambient temperature	T <sub>A</sub>	0		70	°C

**Block Diagram**

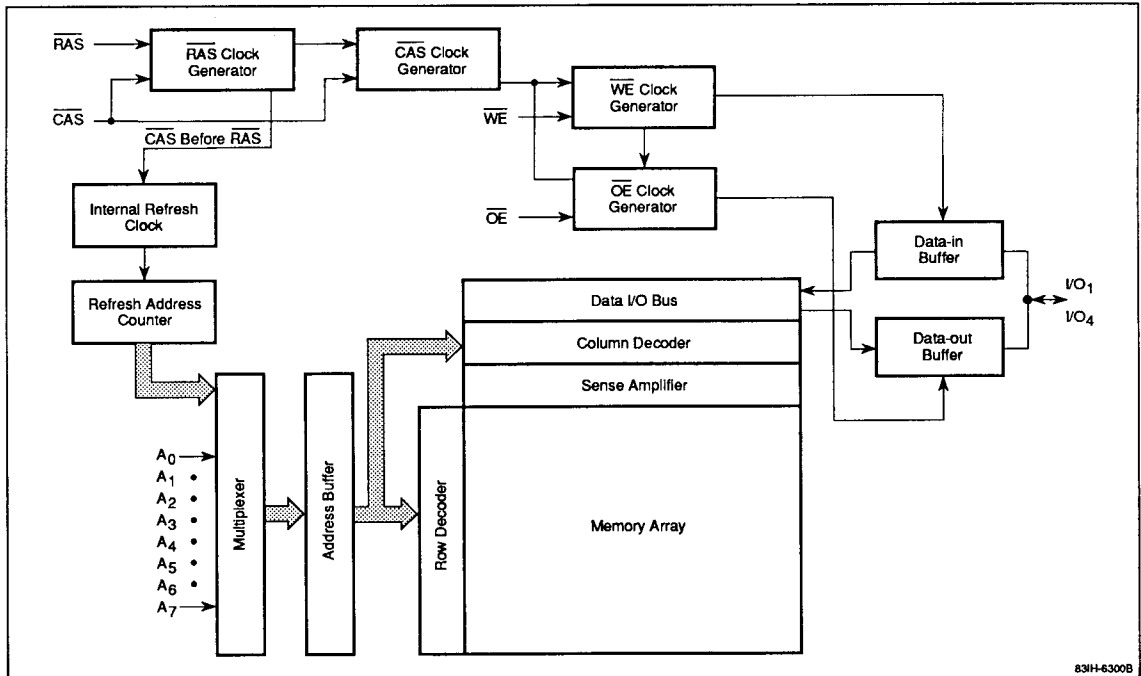

83H-6300B

## DC Characteristics

T<sub>A</sub> = 0 to +70°C; V<sub>CC</sub> = +5.0 V ±10%

Parameter	Symbol	Min	Max	Unit	Test Conditions
Standby current	I <sub>CC2</sub>		5.0	mA	$\overline{RAS} = \overline{CAS} = V_{IH}$
Input leakage current	I <sub>I(L)</sub>	-10	10	μA	V <sub>IN</sub> = 0 V to V <sub>CC</sub> ; all other pins not under test = 0 V
Output leakage current	I <sub>O(L)</sub>	-10	10	μA	I/O is high-Z; V <sub>IO</sub> = 0 V to V <sub>CC</sub>
Output voltage, low	V <sub>OL</sub>	0	0.4	V	I <sub>OL</sub> = 4.2 mA
Output voltage, high	V <sub>OH</sub>	2.4	V <sub>CC</sub>	V	I <sub>OH</sub> = -5 mA

## AC Characteristics

T<sub>A</sub> = 0 to +70°C; V<sub>CC</sub> = +5.0 V ±10%

Parameter	Symbol	μPD41464-80		μPD41464-10		μPD41464-12		Unit	Test Conditions
		Min	Max	Min	Max	Min	Max		
Operating current, average	I <sub>CC1</sub>		85		80		75	mA	$\overline{RAS}, \overline{CAS}$ cycling; t <sub>RC</sub> = t <sub>RC</sub> min (Note 5)
Operating current, refresh cycle, average	I <sub>CC3</sub>		70		65		60	mA	$\overline{RAS}$ cycling; $\overline{CAS} = V_{IH}$ ; t <sub>RC</sub> = t <sub>RC</sub> min (Note 5)
Operating current, page cycle, average	I <sub>CC4</sub>		60		55		50	mA	$\overline{RAS} = V_{IL}$ ; $\overline{CAS}$ cycling; t <sub>PC</sub> = t <sub>PC</sub> min (Note 5)
Operating current, $\overline{CAS}$ before $\overline{RAS}$ refresh cycle, average	I <sub>CC5</sub>		70		70		65	mA	$\overline{RAS}$ cycling; $\overline{CAS} \geq V_{IH}$ ; t <sub>RC</sub> = t <sub>RC</sub> min (Note 5)
Random read or write cycle time	t <sub>RC</sub>	160		200		220		ns	(Note 6)
Read-write cycle time	t <sub>RWC</sub>	230		270		300		ns	(Note 6)
Page cycle time	t <sub>PC</sub>	70		100		120		ns	(Note 6)
Refresh period	t <sub>REF</sub>		4		4		4	ms	
Access time from $\overline{RAS}$	t <sub>RAC</sub>		80		100		120	ns	(Notes 7, 8)
Access time from $\overline{CAS}$	t <sub>CAC</sub>		40		50		60	ns	(Notes 7, 9)
Output buffer turnoff delay	t <sub>OFF</sub>	0	20	0	25	0	30	ns	(Note 10)
Rise and fall transition time	t <sub>T</sub>	3	50	3	50	3	50	ns	(Notes 2, 3)
$\overline{RAS}$ precharge time	t <sub>RP</sub>	70		90		90		ns	
$\overline{RAS}$ pulse width	t <sub>RAS</sub>	80	10000	100	10000	120	10000	ns	
$\overline{RAS}$ hold time	t <sub>RSH</sub>	40		50		60		ns	
$\overline{CAS}$ pulse width	t <sub>CAS</sub>	40	10000	50	10000	60	10000	ns	
$\overline{CAS}$ hold time	t <sub>CSH</sub>	80		100		120		ns	
$\overline{RAS}$ to $\overline{CAS}$ delay time	t <sub>RCD</sub>	20	40	20	50	25	60	ns	(Note 11)
$\overline{CAS}$ to $\overline{RAS}$ precharge time	t <sub>CRP</sub>	10		10		10		ns	(Note 12)
$\overline{CAS}$ precharge time for nonpage cycle	t <sub>CPN</sub>	25		25		25		ns	
$\overline{CAS}$ precharge time for page cycle	t <sub>CP</sub>	30		40		50		ns	
$\overline{RAS}$ precharge $\overline{CAS}$ hold time	t <sub>RPC</sub>		0		0		0	ns	
Row address setup time	t <sub>ASR</sub>	0		0		0		ns	
Row address hold time	t <sub>RAH</sub>	10		10		15		ns	
Column address setup time	t <sub>ASC</sub>	0		0		0		ns	
Column address hold time	t <sub>CAH</sub>	15		15		20		ns	
Column address hold time referenced to $\overline{RAS}$	t <sub>AR</sub>	55		65		80		ns	

### AC Characteristics (cont)

Parameter	Symbol	μPD41464-80		μPD41464-10		μPD41464-12		Unit	Test Conditions
		Min	Max	Min	Max	Min	Max		
Read command hold time referenced to $\overline{\text{RAS}}$	$t_{RRH}$	10		10		10		ns	(Note 13)
Read command hold time referenced to $\overline{\text{CAS}}$	$t_{RCH}$	0		0		0		ns	(Note 13)
Write command hold time	$t_{WCH}$	20		25		30		ns	
Write command hold time referenced to $\overline{\text{RAS}}$	$t_{WCR}$	60		75		90		ns	
Write command pulse width	$t_{WP}$	20		15		20		ns	
Write command to $\overline{\text{RAS}}$ lead time	$t_{RWL}$	30		35		40		ns	
Write command to $\overline{\text{CAS}}$ lead time	$t_{CWL}$	30		35		40		ns	
Data-in setup time	$t_{DS}$	0		0		0		ns	(Note 14)
Data-in hold time	$t_{DH}$	20		25		30		ns	(Note 14)
Data-in hold time referenced to $\overline{\text{RAS}}$	$t_{DHR}$	60		75		90		ns	
Write command setup time	$t_{WCS}$	0		0		0		ns	(Note 15)
$\overline{\text{RAS}}$ to $\overline{\text{WE}}$ delay	$t_{RWD}$	105		130		155		ns	(Note 15)
$\overline{\text{CAS}}$ to $\overline{\text{WE}}$ delay	$t_{CWD}$	65		80		95		ns	(Note 15)
Access time from $\overline{\text{OE}}$	$t_{OEA}$		20		25		30	ns	
Data delay time	$t_{OED}$	20		25		30		ns	
$\overline{\text{OE}}$ command hold time	$t_{OEH}$	0		0		0		ns	
Output turnoff delay from $\overline{\text{OE}}$	$t_{OEZ}$	0	20	0	25	0	30	ns	
$\overline{\text{OE}}$ to $\overline{\text{RAS}}$ inactive setup time	$t_{OES}$	10		10		10		ns	
Read or write cycle time for counter test cycle	$t_{TRC}$	185		220		245		ns	(Note 16)
Read or write cycle time for counter test cycle	$t_{TRWC}$	245		290		325		ns	(Note 16)
$\overline{\text{CAS}}$ setup time for $\overline{\text{CAS}}$ before $\overline{\text{RAS}}$ refresh cycle	$t_{CSR}$	10		10		10		ns	
$\overline{\text{CAS}}$ hold time for $\overline{\text{CAS}}$ before $\overline{\text{RAS}}$ refresh cycle	$t_{CHR}$	15		20		25		ns	

### Notes:

- (1) An initial pause of 100 μs ( $\overline{\text{RAS}}$  inactive) is required after power-up, followed by any eight  $\overline{\text{RAS}}$  cycles, before proper device operation is achieved.
- (2) AC measurements assume  $t_T = 5$  ns.
- (3)  $V_{IH}$  (min) and  $V_{IL}$  (max) are reference levels for measuring the timing of input signals.
- (4) All voltages are referenced to GND.
- (5)  $I_{CC1}$ ,  $I_{CC3}$ ,  $I_{CC4}$ , and  $I_{CC5}$  depend on output loading and cycle rates. Specified values are obtained with the output open. For lot code K of the μPD41464-15,  $t_{RC}$  (min) must be 270 ns and  $I_{CC3} = 60$  mA.
- (6) The minimum specifications are used only to indicate the cycle time at which proper operation over the full temperature range ( $T_A = 0$  to  $+70^\circ\text{C}$ ) is assured. For lot code K of the μPD41464-15,  $t_{RC}$  (min) must be 270 ns.
- (7) Load = 2 TTL loads and 100 pF
- (8) Assumes that  $t_{RCD} \leq t_{RCD}(\text{max})$ . If  $t_{RCD}$  is greater than the maximum recommended value in this table,  $t_{RAC}$  increases by the amount that  $t_{RCD}$  exceeds the value shown. For a  $\overline{\text{CAS}}$  before  $\overline{\text{RAS}}$  refresh counter test cycle,  $t_{RAC}$  is specified as  $t_{RAC} = t_{CHR} + t_{CP} + t_{CAC} + 2t_T$  and is greater than the maximum specified value shown in this table.
- (9) Assumes that  $t_{RCD} \geq t_{RCD}(\text{max})$ .
- (10)  $t_{OFF}(\text{max})$  and  $t_{OEZ}(\text{max})$  define the time at which the output achieves the open-circuit condition and are not referenced to  $V_{OH}$  or  $V_{OL}$ .
- (11) Operation within the  $t_{RCD}(\text{max})$  limit assures that  $t_{RAC}(\text{max})$  can be met.  $t_{RCD}(\text{max})$  is specified as a reference point only; if  $t_{RCD}$  is greater than  $t_{RCD}(\text{max})$ , access time is controlled exclusively by  $t_{CAC}$ .
- (12) The  $t_{CRP}$  requirement should be applicable for  $\overline{\text{RAS}}/\overline{\text{CAS}}$  cycles preceded by any cycle.
- (13) Either  $t_{RRH}$  or  $t_{RCH}$  must be satisfied for a read cycle.
- (14) These parameters are referenced to the leading edge of  $\overline{\text{CAS}}$  for early write cycles and to the leading edge of  $\overline{\text{WE}}$  for delayed write or read-modify-write cycles.
- (15)  $t_{WCS}$ ,  $t_{CWD}$ , and  $t_{RWD}$  are restrictive operating parameters in read-write/read-modify-write cycles only. If  $t_{WCS} \geq t_{WCS}(\text{min})$ , the cycle is an early write cycle and the data I/O pins will remain high impedance throughout the entire cycle. If  $t_{CWD} \geq t_{CWD}(\text{min})$ ,  $t_{RWD} \geq t_{RWD}(\text{min})$ , the cycle is a read-write cycle and the data I/O pins will contain data read from the selected cell. If neither of the above conditions is met, the condition of the data I/O pins (at access time and until  $\overline{\text{CAS}}$  returns to  $V_{IH}$ ) is indeterminate.
- (16)  $t_{TRC}$  and  $t_{TRWC}$  are applicable for  $\overline{\text{CAS}}$  before  $\overline{\text{RAS}}$  refresh counter test cycles.

Timing Waveforms

Read Cycle

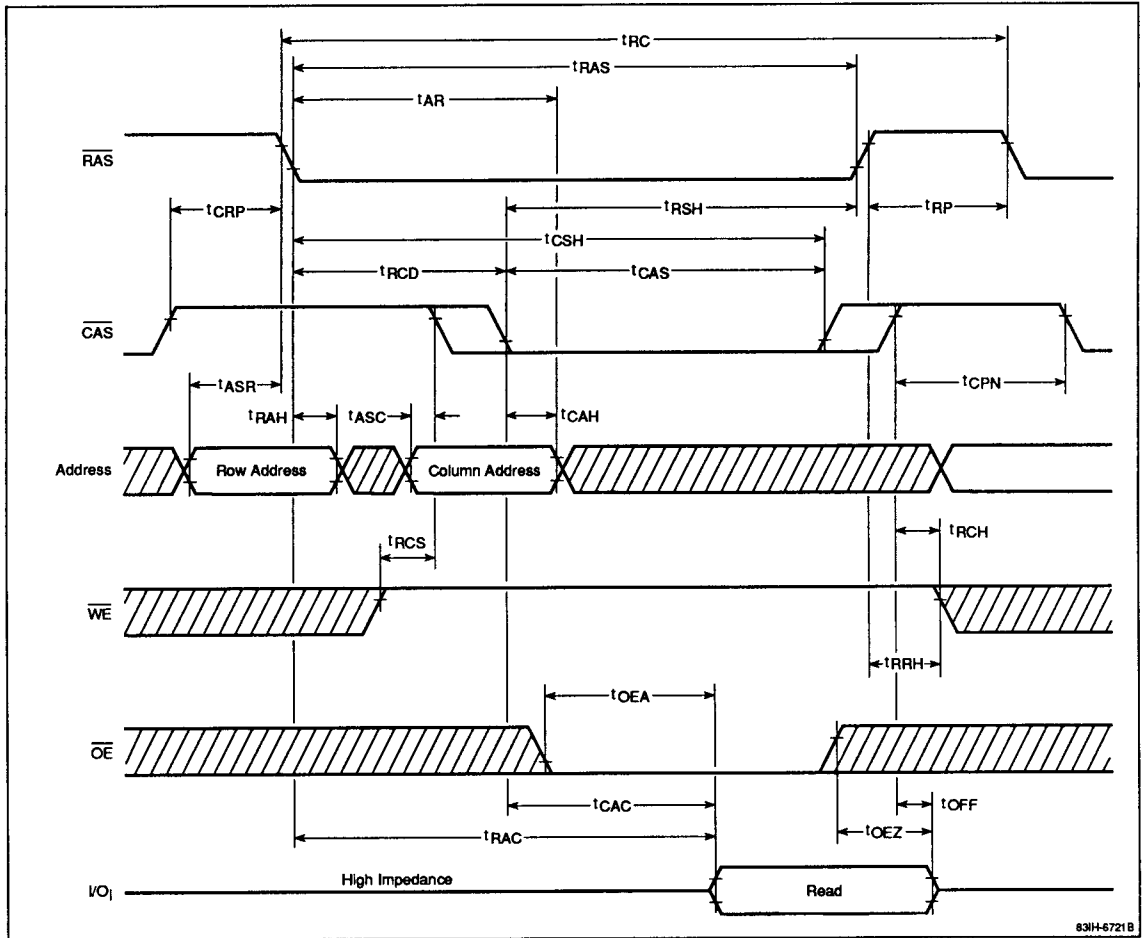

## Timing Waveforms (cont)

### Early Write Cycle

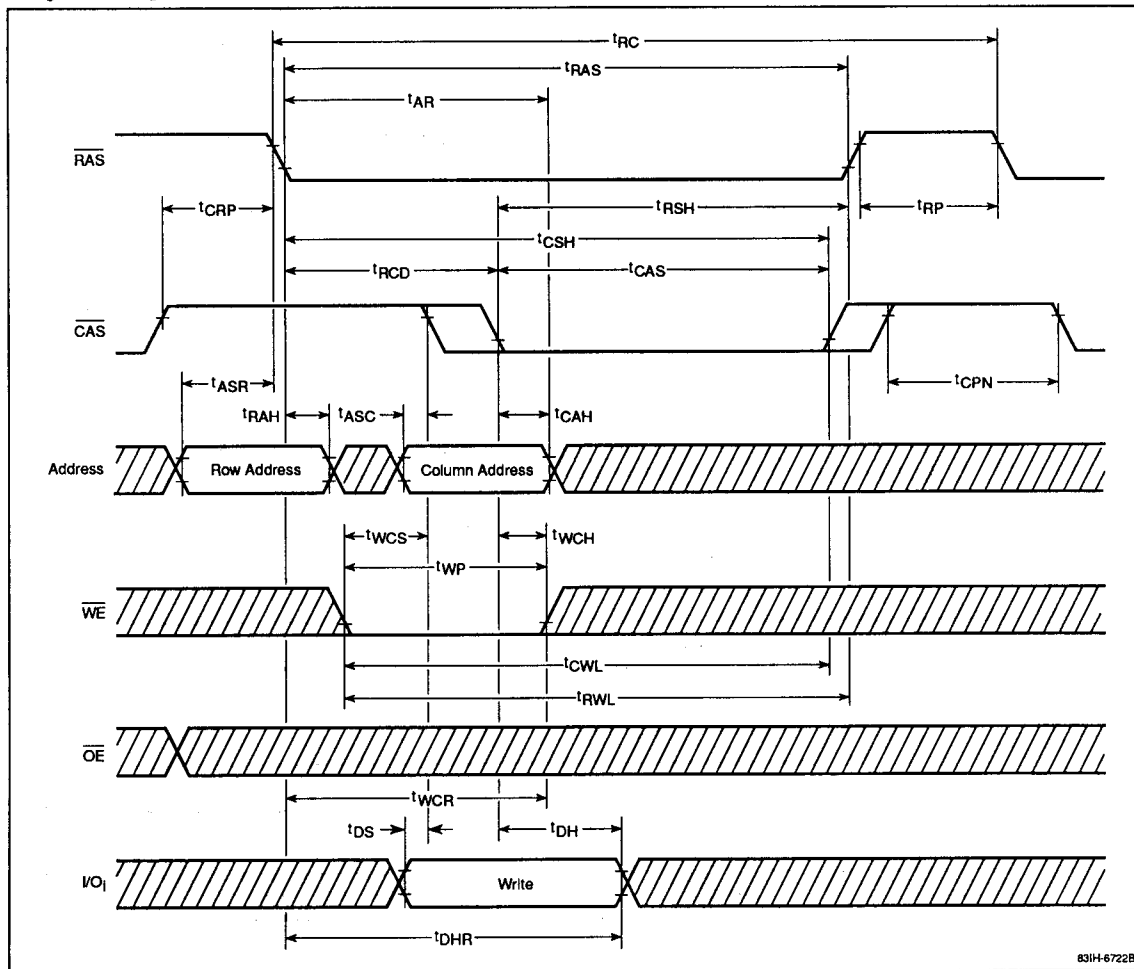

3b

Timing Waveforms (cont)

**$\overline{OE}$ -Controlled Write Cycle**

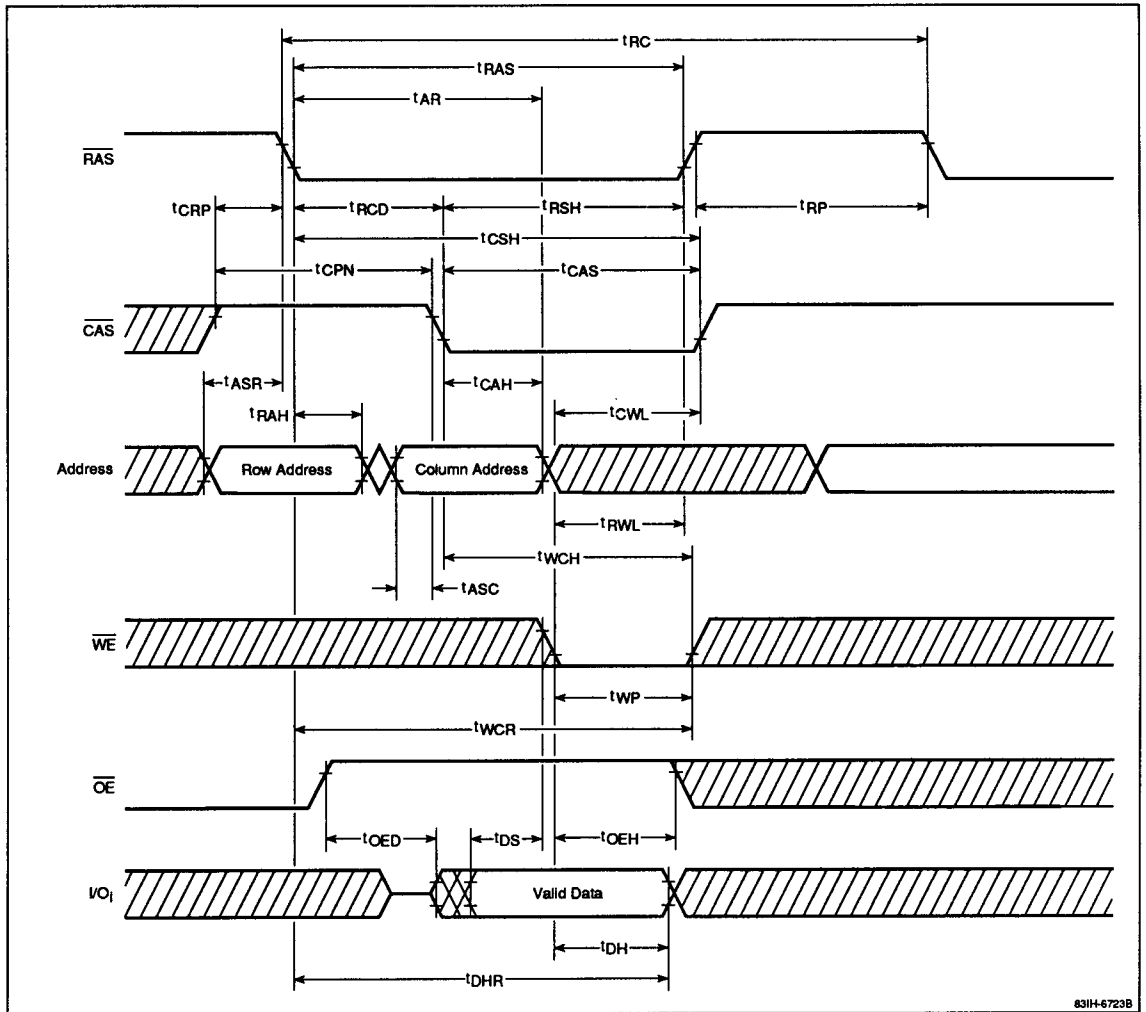



## Timing Waveforms (cont)

### Read-Write/Read-Modify-Write Cycle

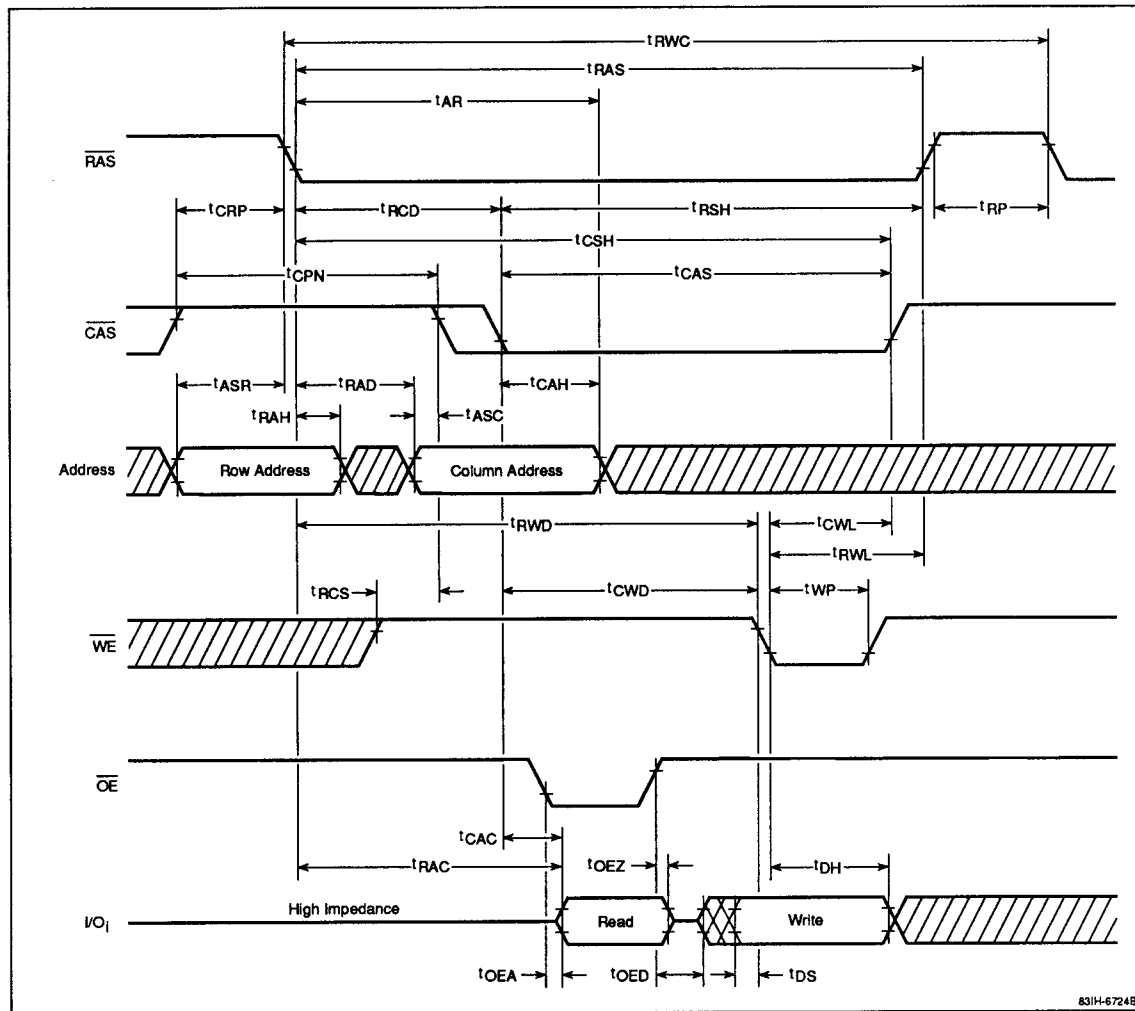

3b

Timing Waveforms (cont)

Page Read Cycle

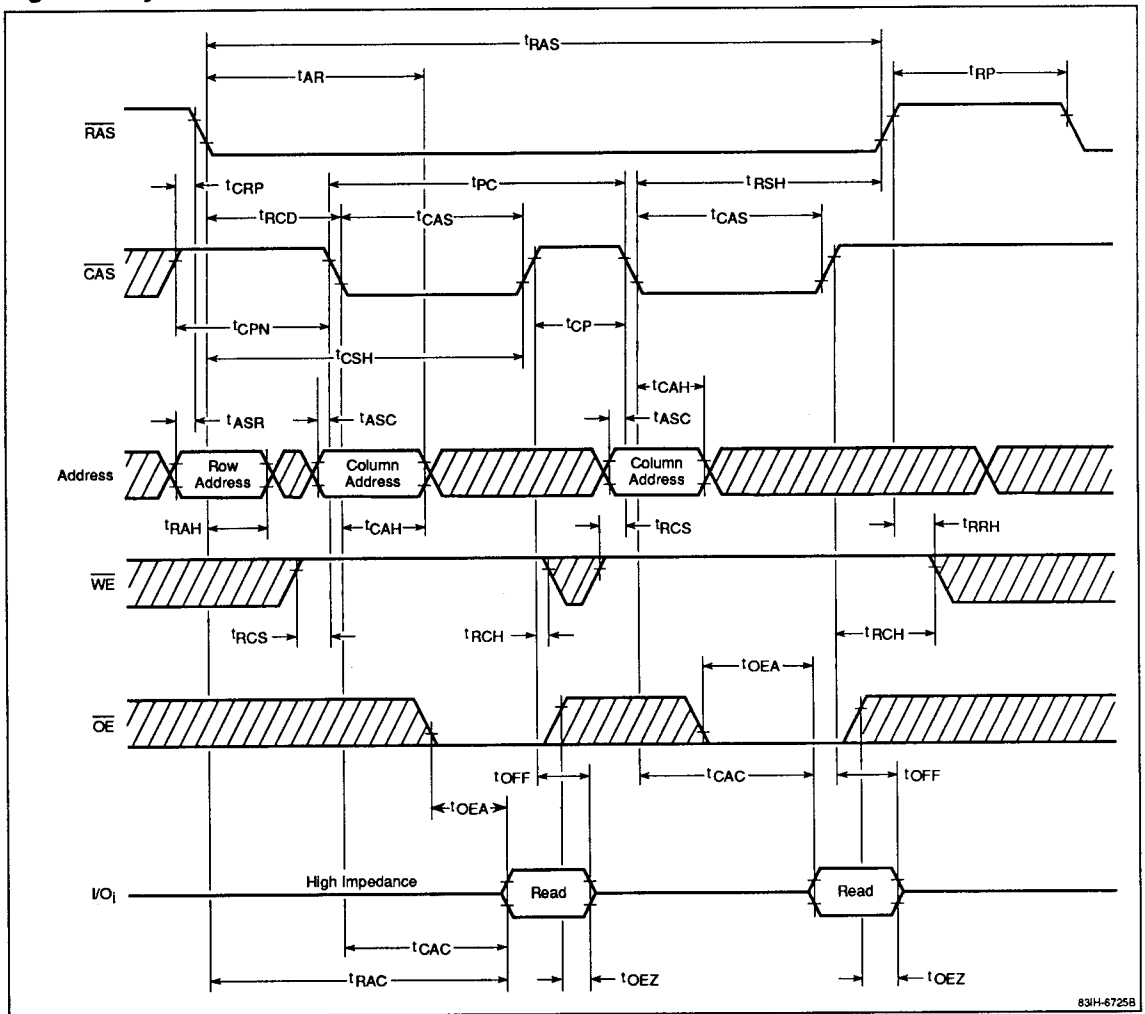

## Timing Waveforms (cont)

### Page Write Cycle (Early Write)

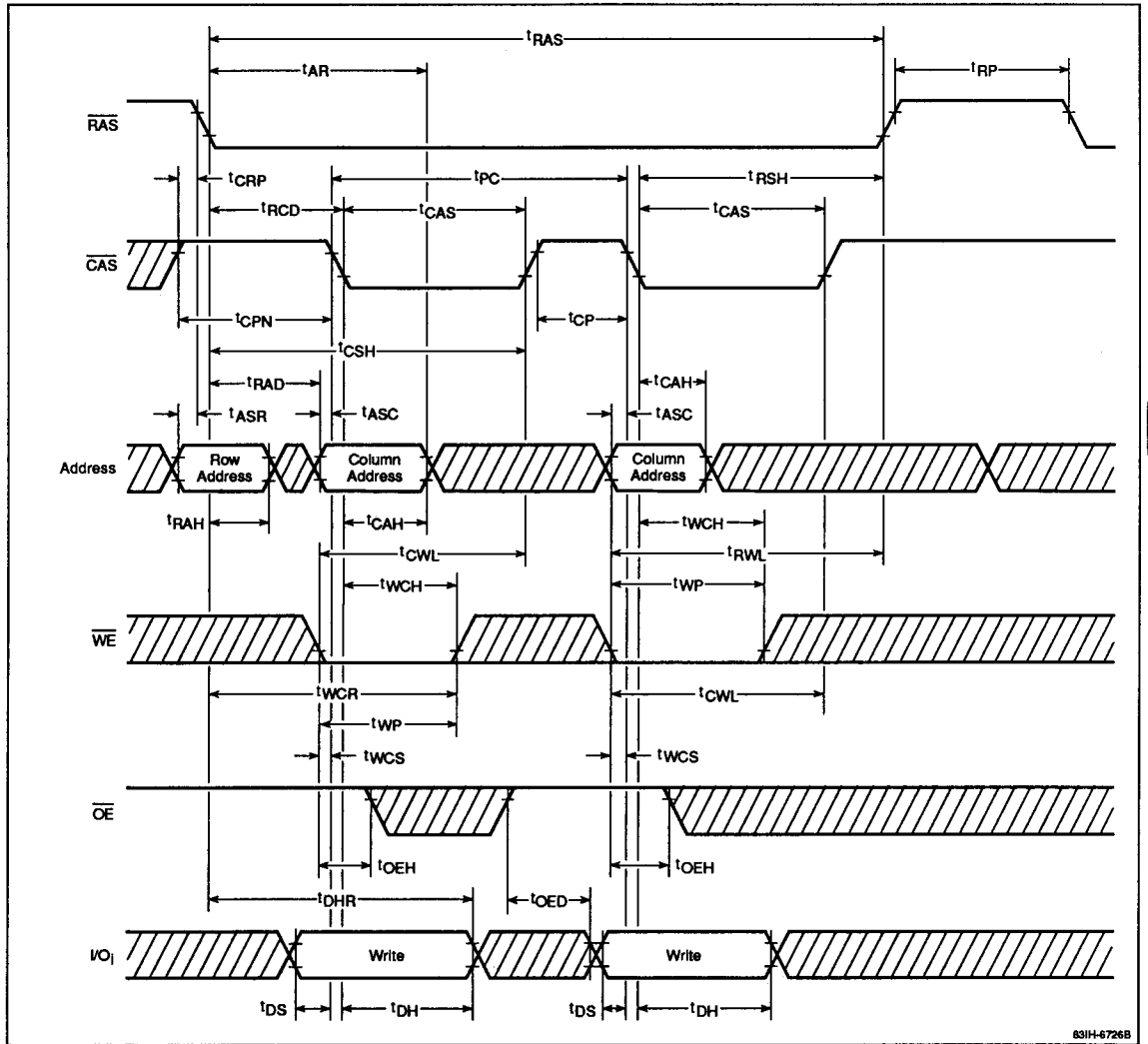

Timing Waveforms (cont)

Page Read-Write/Read-Modify-Write Cycle

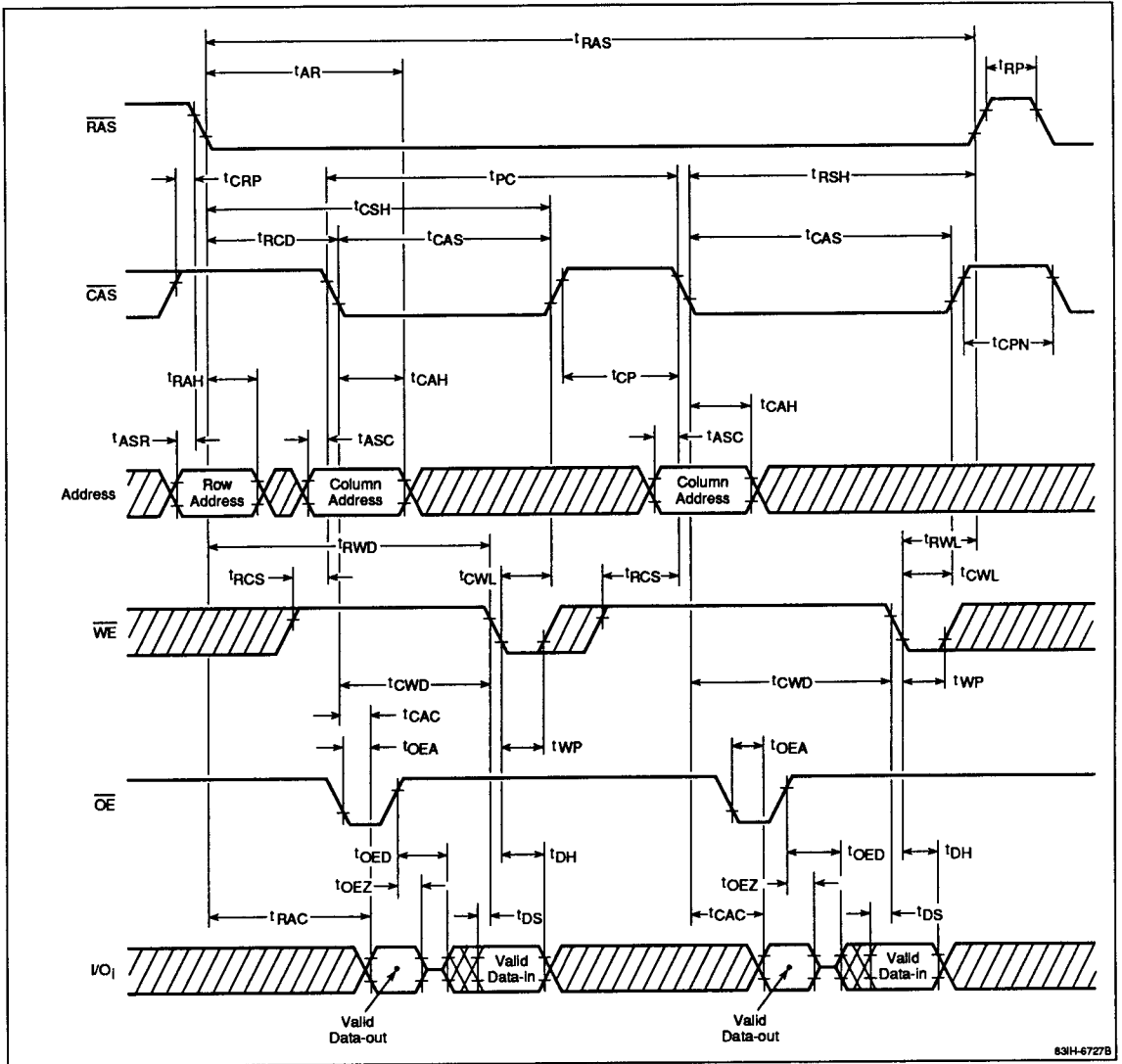

## Timing Waveforms (cont)

### RAS-Only Refresh Cycle

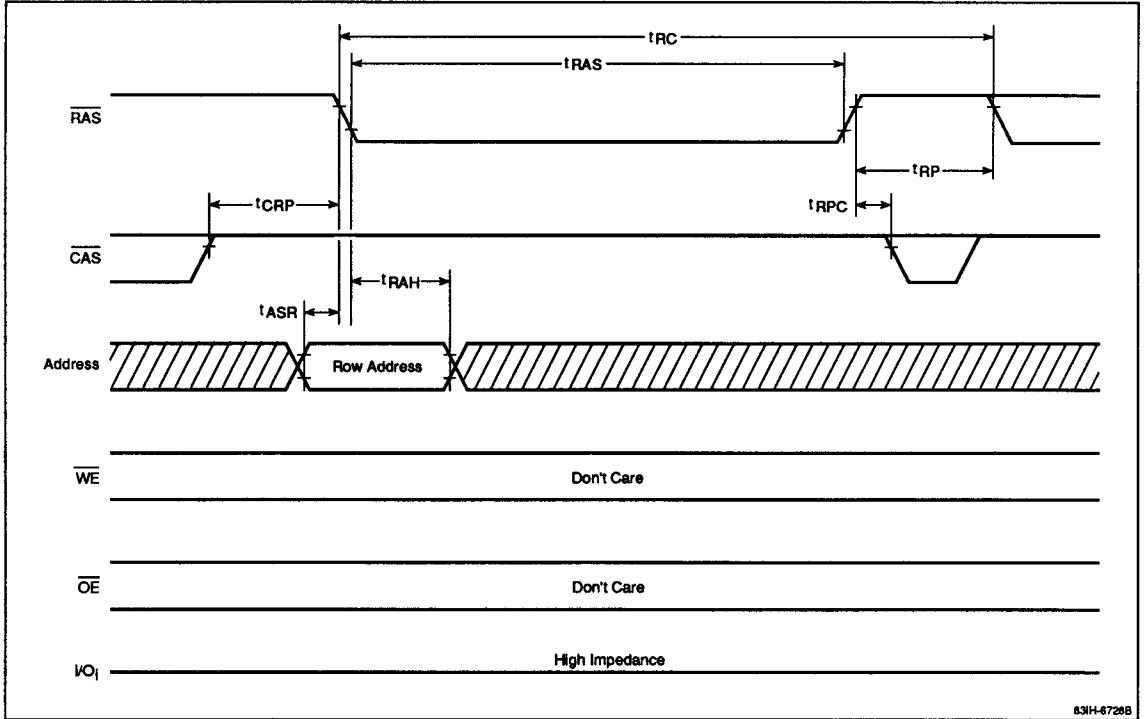

3b

**Timing Waveforms (cont)**

**CAS Before RAS Refresh Cycle**

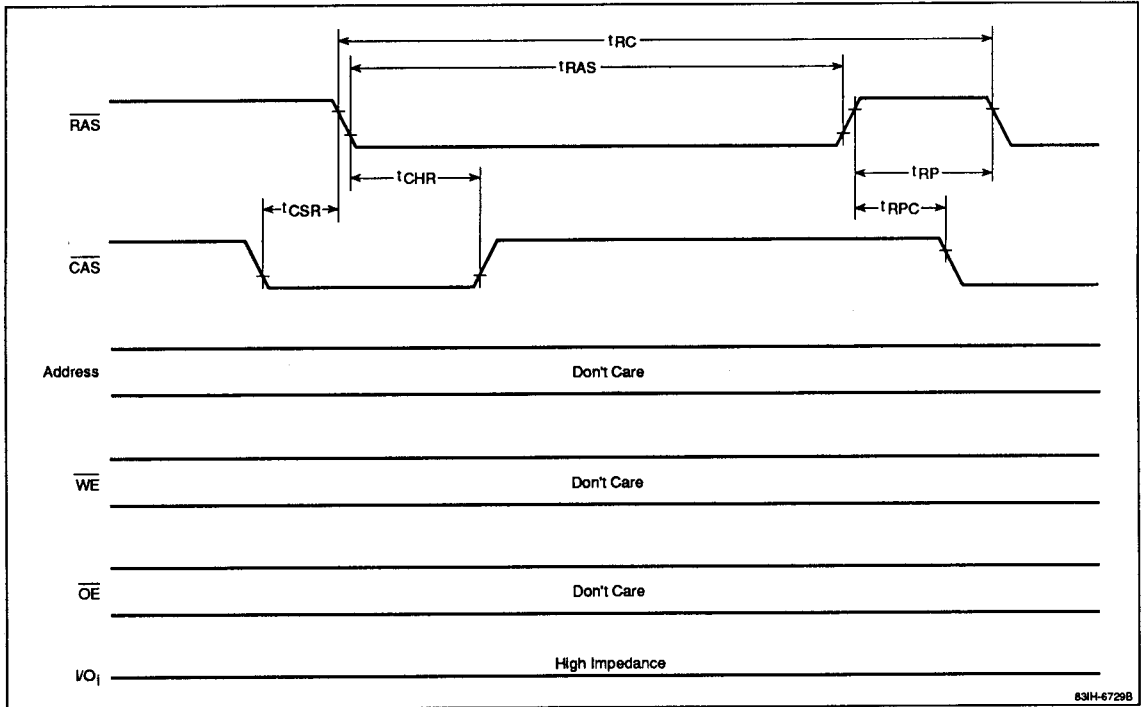



**$\overline{\text{CAS}}$  Before  $\overline{\text{RAS}}$  Refresh Counter Test**

The μPD41464 provides a method to verify proper operation of the internal address counter used in  $\overline{\text{CAS}}$  before  $\overline{\text{RAS}}$  refreshing. After a  $\overline{\text{CAS}}$  before  $\overline{\text{RAS}}$  refresh cycle is initiated,  $\overline{\text{CAS}}$  satisfies a hold time ( $t_{\text{CHP}}$ ), a precharge time ( $t_{\text{CP}}$ ), and then returns low while  $\overline{\text{RAS}}$  is held low to enable read, write, or read-modify-write operation. As shown in the appropriate timing waveforms, a refresh counter test can be initiated at this point on specified row and column addresses. The row is selected by the internal address counter, and the column is defined by an external address supplied at the second falling edge of  $\overline{\text{CAS}}$ . Test patterns can be generated in several ways; the following example is one possibility. Any pattern must be preceded by the normal power-up procedure containing a pause of 100 μs and then eight  $\overline{\text{RAS}}$  cycles to initialize the internal counter.

- (1) Write "0" into 256 memory cells with 256  $\overline{\text{CAS}}$  before  $\overline{\text{RAS}}$  refresh counter test write cycles. Use the same column address in each cycle.
- (2) Use a counter test read-modify-write cycle to read the "0" written in the first cycle of step 1 and then write a "1" into that location in the same cycle. Perform this operation 256 times, until a "1" is written into each of the 256 memory cells. Continue using the same column address as specified in step 1.
- (3) Read each "1" written in step 2 using a counter test read cycle.
- (4) Complement the test pattern and repeat steps 1, 2, and 3.



## Timing Waveforms (cont)

### CAS Before RAS Refresh Counter Test Read Cycle

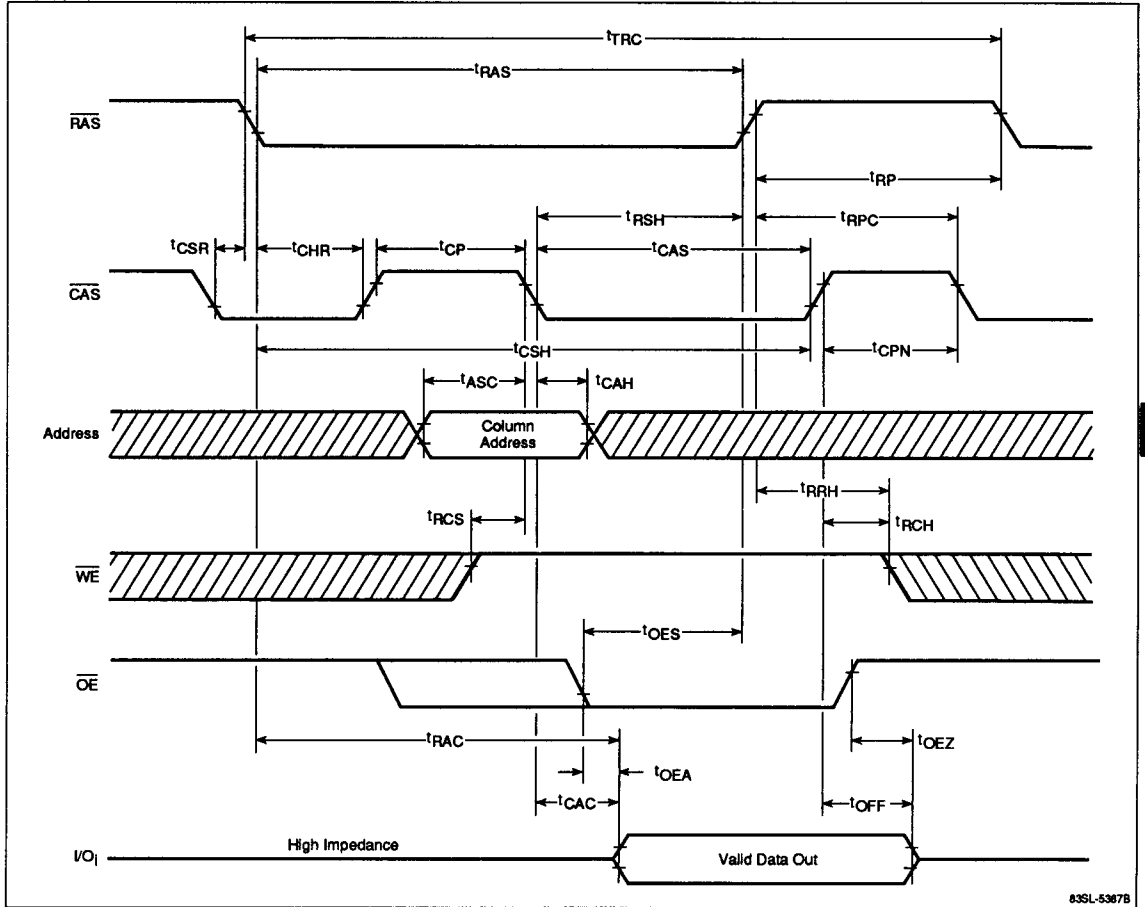

3b

Timing Waveforms (cont)

**CAS Before RAS Refresh Counter Test Write Cycle**

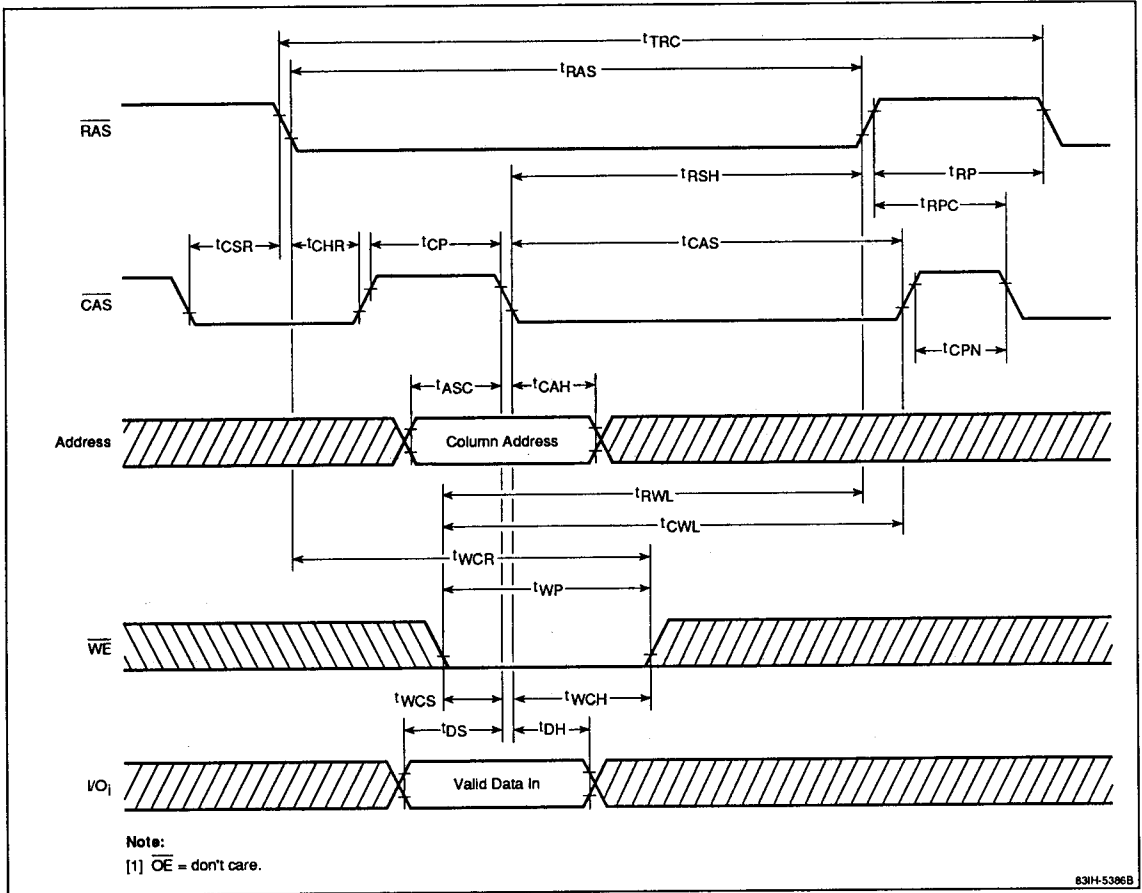

## Timing Waveforms (cont)

### CAS Before RAS Refresh Counter Test Read-Modify-Write Cycle

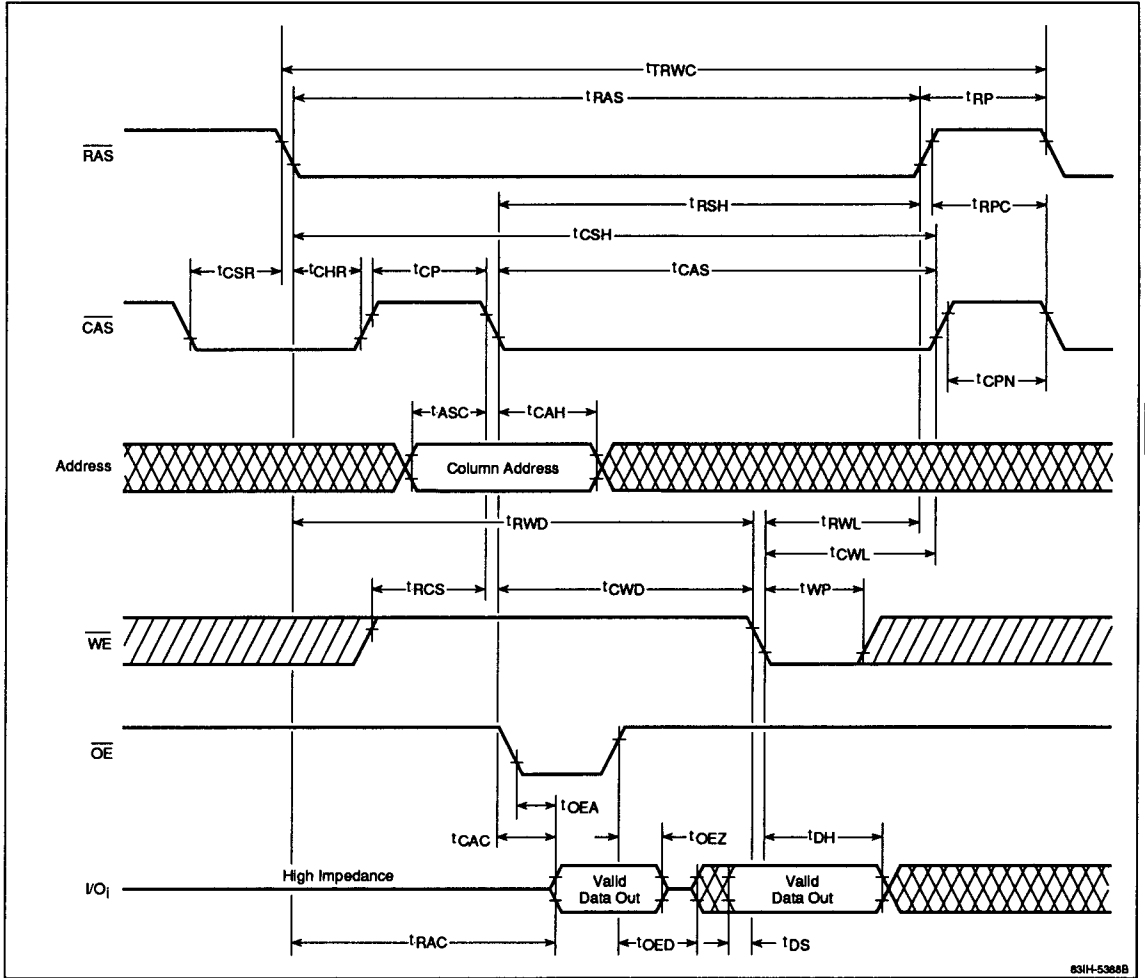

3b