

PNP Silicon AF Transistors

- For AF driver and output stages
- High collector current
- Low collector-emitter saturation voltage
- Complementary types: BCX 54 ... BCX 56 (NPN)

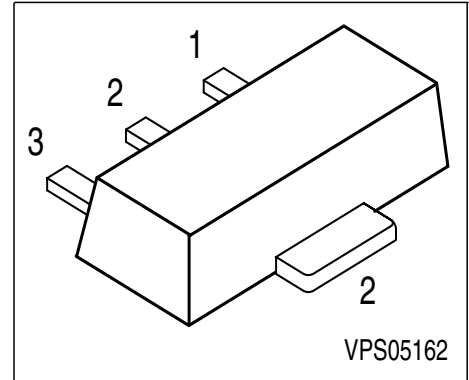

Type	Marking	Pin Configuration			Package
BCX 51	AA	1 = B	2 = C	3 = E	SOT-89
BCX 51-10	AC	1 = B	2 = C	3 = E	SOT-89
BCX 51-16	AD	1 = B	2 = C	3 = E	SOT-89
BCX 52	AE	1 = B	2 = C	3 = E	SOT-89
BCX 52-10	AG	1 = B	2 = C	3 = E	SOT-89
BCX 52-16	AM	1 = B	2 = C	3 = E	SOT-89
BCX 53	AH	1 = B	2 = C	3 = E	SOT-89
BCX 53-10	AK	1 = B	2 = C	3 = E	SOT-89
BCX 53-16	AL	1 = B	2 = C	3 = E	SOT-89

**Maximum Ratings**

Parameter	Symbol	BCX 51	BCX 52	BCX 53	Unit
Collector-emitter voltage	$V_{CEO}$	45	60	80	V
Collector-base voltage	$V_{CBO}$	45	60	100	
Emitter-base voltage	$V_{EBO}$	5	5	5	
DC collector current	$I_C$	1			A
Peak collector current	$I_{CM}$	1.5			
Base current	$I_B$	100			mA
Peak base current	$I_{BM}$	200			
Total power dissipation, $T_S = 130\text{ °C}$	$P_{tot}$	1			W
Junction temperature	$T_j$	150			°C
Storage temperature	$T_{stg}$	-65 ... 150			

**Thermal Resistance**

Junction ambient <sup>1)</sup>	$R_{thJA}$	≤75			K/W
Junction - soldering point	$R_{thJS}$	≤20			

1) Package mounted on pcb 40mm x 40mm x 1.5mm / 6cm<sup>2</sup> Cu

**Electrical Characteristics** at  $T_A = 25^\circ\text{C}$ , unless otherwise specified.

Parameter	Symbol	Values			Unit
		min.	typ.	max.	
<b>DC Characteristics</b>					
Collector-emitter breakdown voltage $I_C = 10\text{ mA}, I_B = 0$	$V_{(BR)CEO}$				V
BXP 51		45	-	-	
BXP 52		60	-	-	
BXP 53		80	-	-	
Collector-base breakdown voltage $I_C = 100\ \mu\text{A}, I_B = 0$	$V_{(BR)CBO}$				
BXP 51		45	-	-	
BXP 52		60	-	-	
BXP 53		100	-	-	
Emitter-base breakdown voltage $I_E = 10\ \mu\text{A}, I_C = 0$	$V_{(BR)EBO}$	5	-	-	
Collector cutoff current $V_{CB} = 30\text{ V}, I_E = 0$	$I_{CBO}$	-	-	100	nA
Collector cutoff current $V_{CB} = 30\text{ V}, I_E = 0, T_A = 150^\circ\text{C}$	$I_{CBO}$	-	-	20	$\mu\text{A}$
DC current gain 1) $I_C = 5\text{ mA}, V_{CE} = 2\text{ V}$	$h_{FE}$	25	-	-	-
DC current gain 1) $I_C = 150\text{ mA}, V_{CE} = 2\text{ V}$	$h_{FE}$				-
BCX51...53		40	-	250	
hFE-grp. 10		63	100	160	
hFE-grp. 16		100	160	250	
DC current gain 1) $I_C = 500\text{ mA}, V_{CE} = 2\text{ V}$	$h_{FE}$	25	-	-	
Collector-emitter saturation voltage1) $I_C = 500\text{ mA}, I_B = 50\text{ mA}$	$V_{CEsat}$	-	-	0.5	V
Base-emitter voltage 1) $I_C = 500\text{ mA}, V_{CE} = 2\text{ V}$	$V_{BE(ON)}$	-	-	1	
<b>AC Characteristics</b>					
Transition frequency $I_C = 50\text{ mA}, V_{CE} = 10\text{ V}, f = 20\text{ MHz}$	$f_T$	-	125	-	MHz

 1) Pulse test:  $t \leq 300\ \mu\text{s}$ ,  $D = 2\%$

**Total power dissipation  $P_{tot} = f(T_A^*; T_S)$**

\* Package mounted on epoxy

**Collector current  $I_C = f(V_{BE})$**

$V_{CE} = 2V$

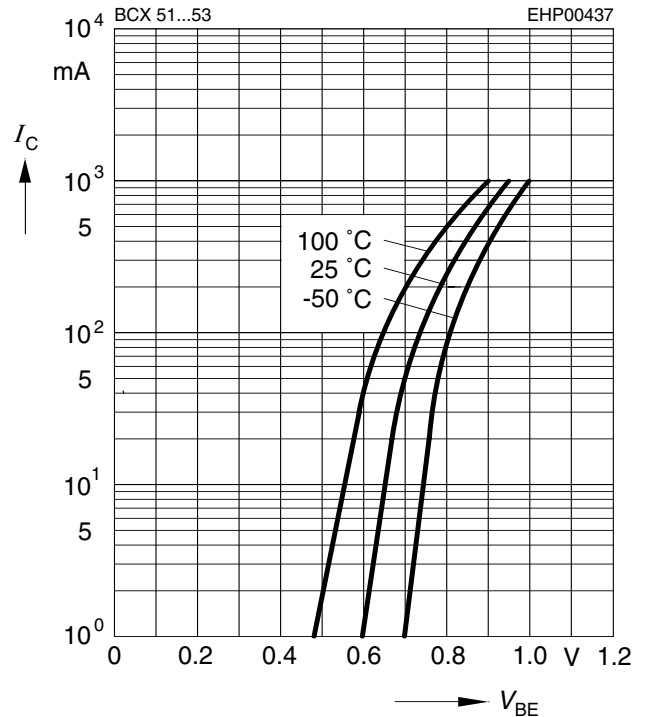
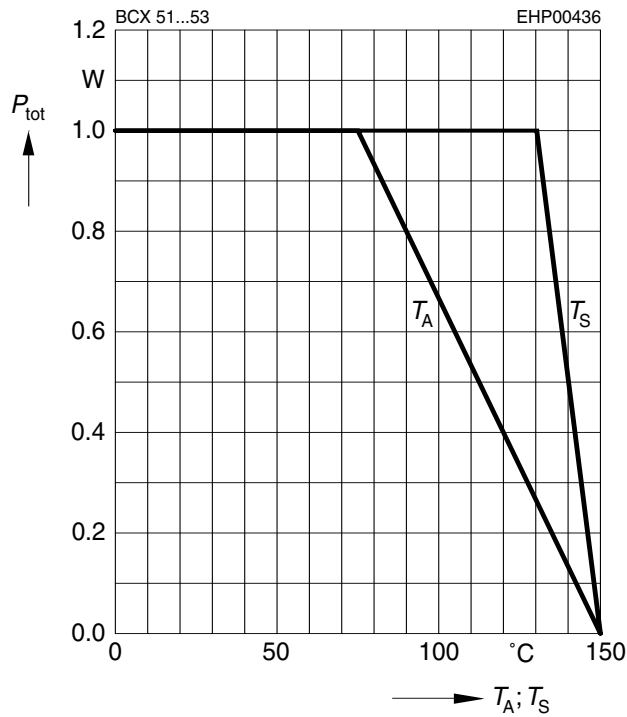

**Permissible pulse load**

$P_{totmax} / P_{totDC} = f(t_p)$

**Transition frequency  $f_T = f(I_C)$**

$V_{CE} = 10V$

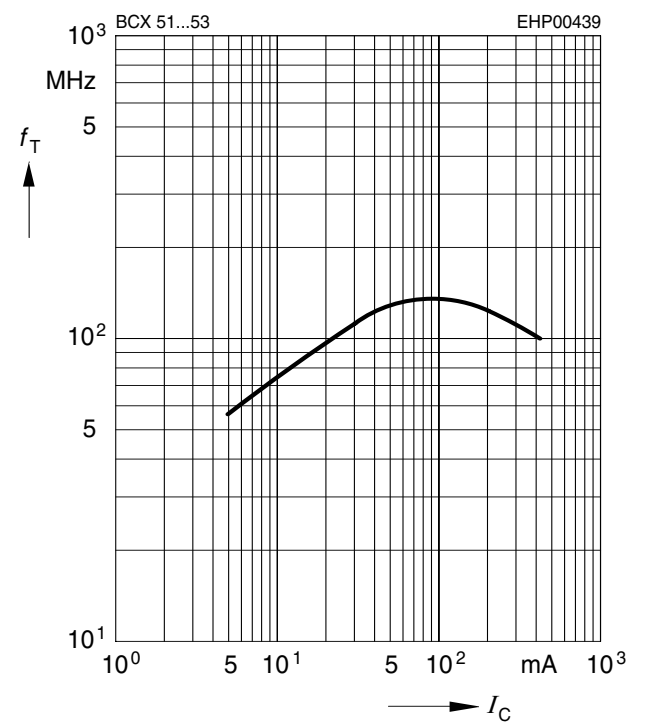
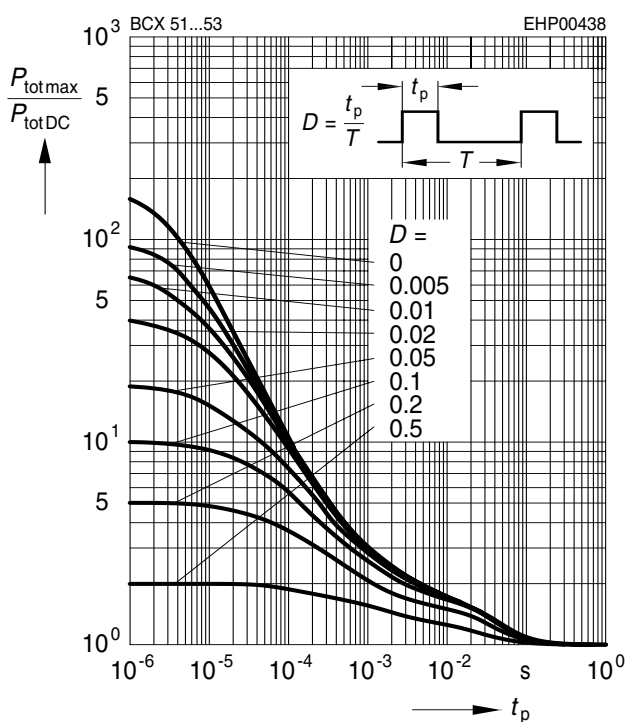

**DC current gain  $h_{FE} = f(I_C)$**

$V_{CE} = 2V$

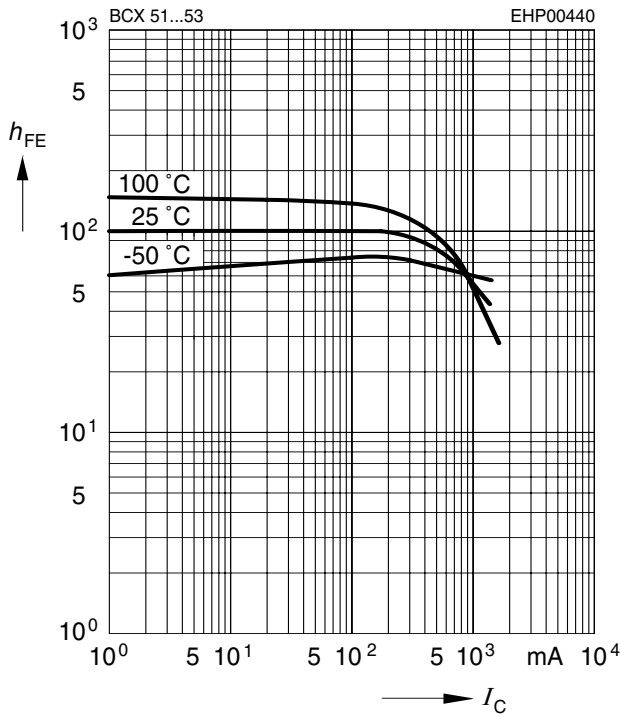

**Collector-emitter saturation voltage**

$I_C = f(V_{CEsat}), h_{FE} = 10$

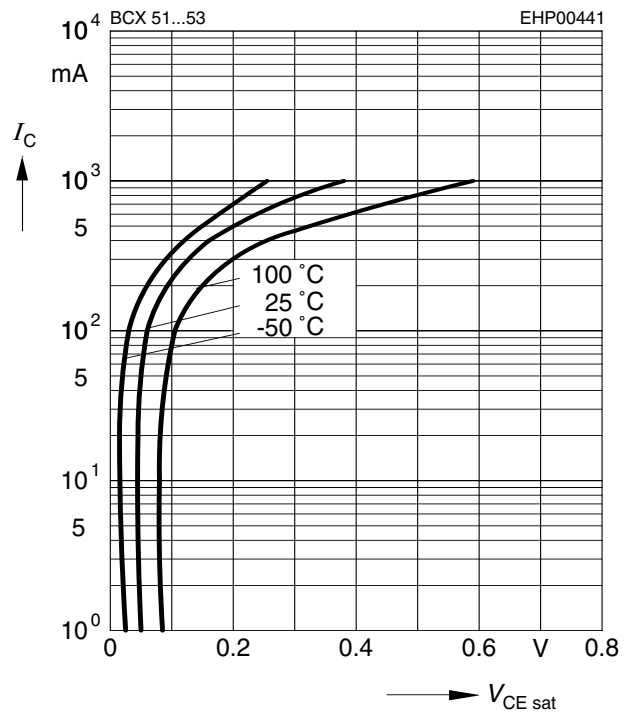

**Collector cutoff current  $I_{CBO} = f(T_A)$**

$V_{CB} = 30V$

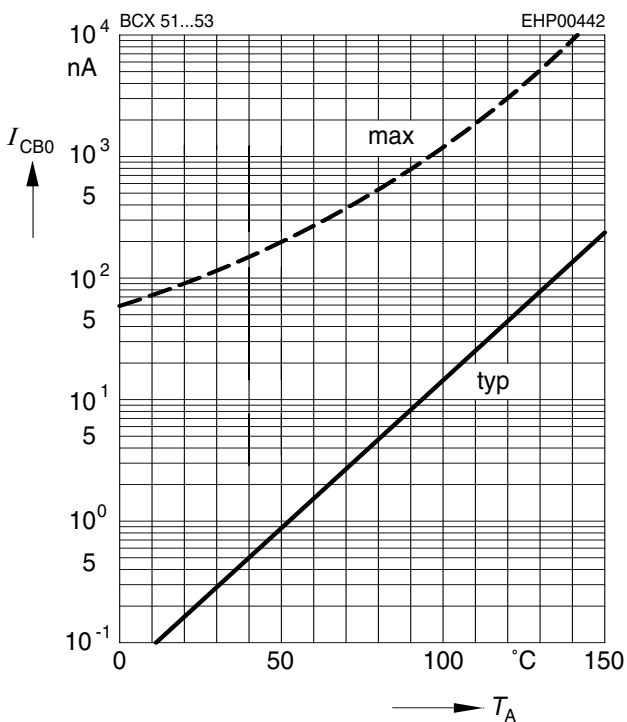

**Base-emitter saturation voltage**

$I_C = f(V_{BEsat}), h_{FE} = 10$

