

## NPN Silicon RF Transistor

**BF 599**

- Common emitter IF/RF amplifier
- Low feedback capacitance due to shield diffusion

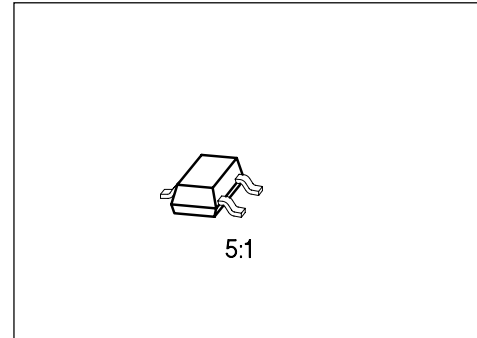

Type	Marking	Ordering Code (tape and reel)	Pin Configuration			Package <sup>1)</sup>
			1	2	3	
BF 599	NB	Q62702-F979	B	E	C	SOT-23

### Maximum Ratings

Parameter	Symbol	Values	Unit
Collector-emitter voltage	$V_{CE0}$	25	V
Collector-base voltage	$V_{CB0}$	40	
Emitter-base voltage	$V_{EB0}$	4	
Collector current	$I_C$	25	mA
Base current	$I_B$	5	
Total power dissipation, $T_A \leq 25\text{ °C}$	$P_{tot}$	280	mW
Junction temperature	$T_j$	150	°C
Storage temperature range	$T_{stg}$	- 65 ... + 150	

### Thermal Resistance

Junction - ambient <sup>2)</sup>	$R_{th JA}$	$\leq 450$	K/W
----------------------------------	-------------	------------	-----

<sup>1)</sup> For detailed information see chapter Package Outlines.

<sup>2)</sup> Package mounted on alumina 15 mm × 16.7 mm × 0.7 mm.

## Electrical Characteristics

at  $T_A = 25\text{ °C}$ , unless otherwise specified.

Parameter	Symbol	Values			Unit
		min.	typ.	max.	

### DC Characteristics

Collector-emitter breakdown voltage $I_C = 1\text{ mA}$ , $I_B = 0$	$V_{(BR)CE0}$	25	–	–	V
Collector cutoff current $V_{CB} = 20\text{ V}$ , $I_E = 0$	$I_{CB0}$	–	–	100	nA
DC current gain $I_C = 7\text{ mA}$ , $V_{CE} = 10\text{ V}$	$h_{FE}$	38	70	–	–
Collector-emitter saturation voltage $I_C = 10\text{ mA}$ , $I_B = 1\text{ mA}$	$V_{CE\text{ sat}}$	–	0.15	–	V
Base-emitter voltage $I_C = 7\text{ mA}$ , $V_{CE} = 10\text{ V}$	$V_{BE}$	–	0.78	–	

### AC Characteristics

Transition frequency $I_C = 5\text{ mA}$ , $V_{CE} = 10\text{ V}$ , $f = 100\text{ MHz}$	$f_T$	–	550	–	MHz
Collector-base capacitance $V_{CB} = 10\text{ V}$ , $V_{BE} = 0\text{ V}$ , $f = 1\text{ MHz}$	$C_{cb}$	–	0.35	–	pF
Collector-emitter capacitance $V_{CE} = 10\text{ V}$ , $V_{BE} = 0\text{ V}$ , $f = 1\text{ MHz}$	$C_{ce}$	–	0.68	–	
Optimum power gain $I_C = 7\text{ mA}$ , $V_{CE} = 10\text{ V}$ , $f = 35\text{ MHz}$	$G_{pe\text{ opt}}$	–	43	–	dB
Forward transfer admittance $I_C = 7\text{ mA}$ , $V_{CE} = 10\text{ V}$ , $f = 35\text{ MHz}$	$ y_{21e} $	–	175	–	mS

**Total power dissipation  $P_{tot} = f(T_A)$**

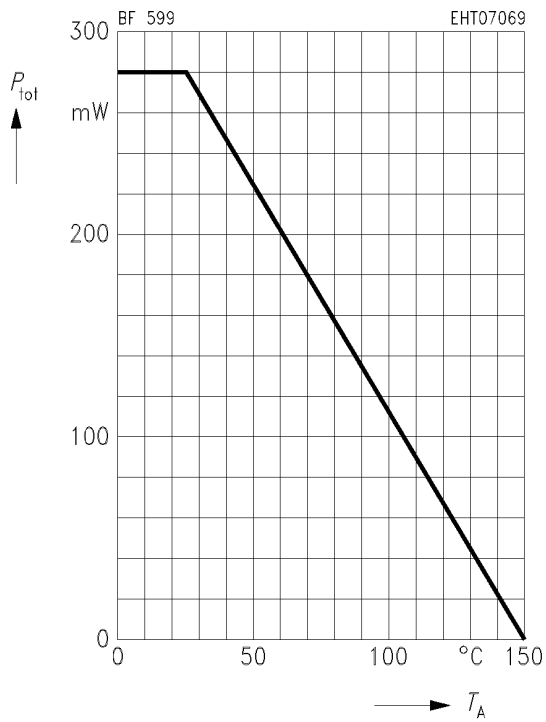

**DC current gain  $h_{FE} = f(I_C)$**

$V_{CE} = 10\text{ V}$

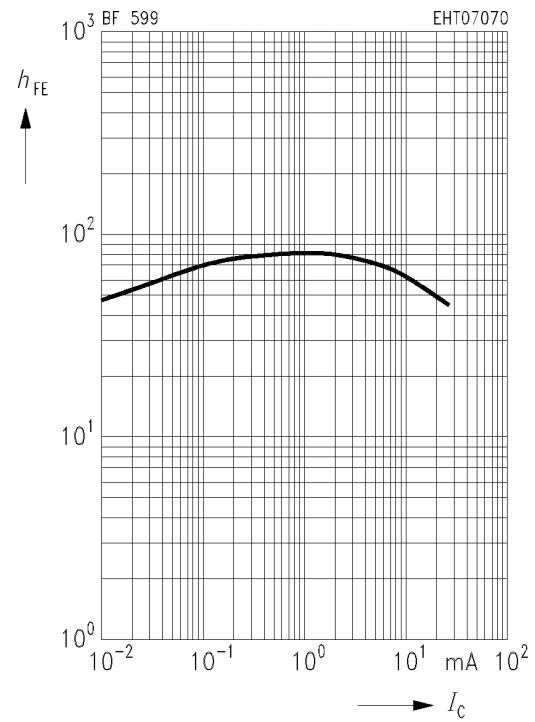

**Collector current  $I_C = f(V_{BE})$**

$V_{CE} = 10\text{ V}$

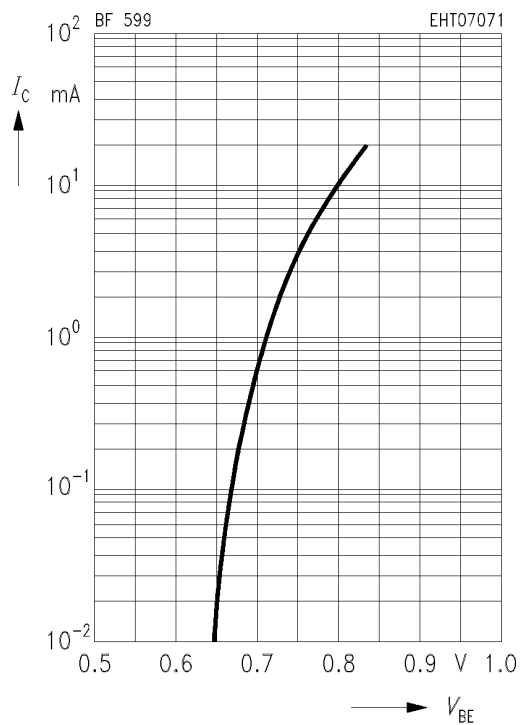

**Collector-emitter saturation voltage  $I_C = f(V_{CEsat})$**

$h_{FE} = 10$

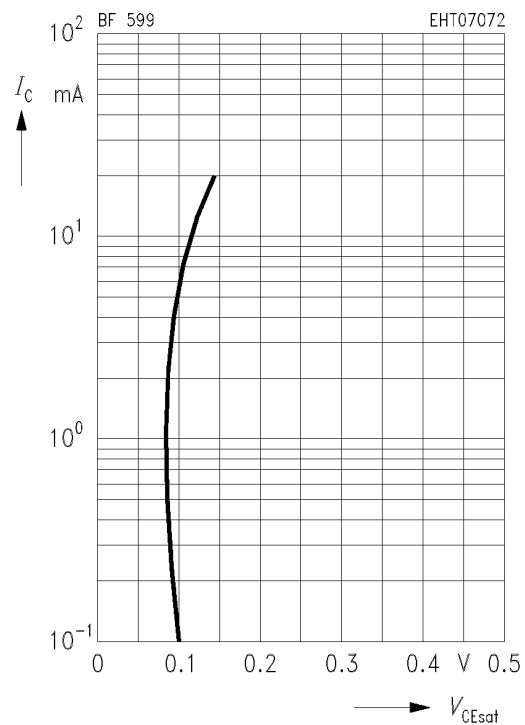

**Collector cutoff current  $I_{CB0} = f(T_A)$**

$V_{CB} = 20\text{ V}$

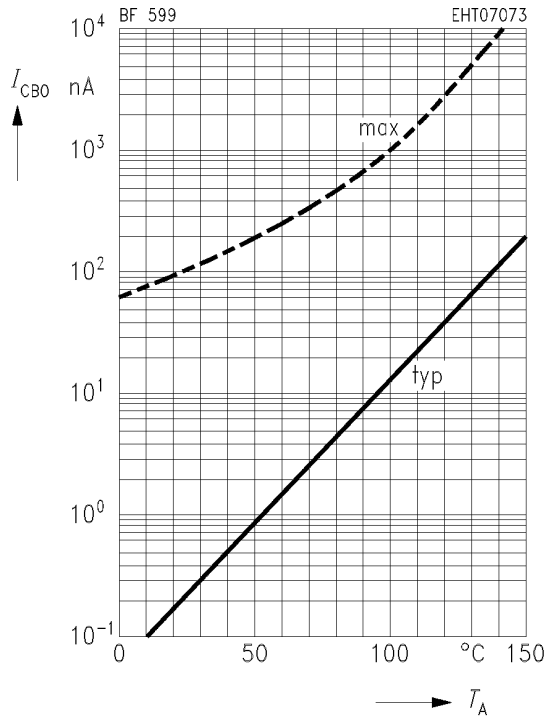

**Transition frequency  $f_T = f(I_C)$**

$f = 100\text{ MHz}$

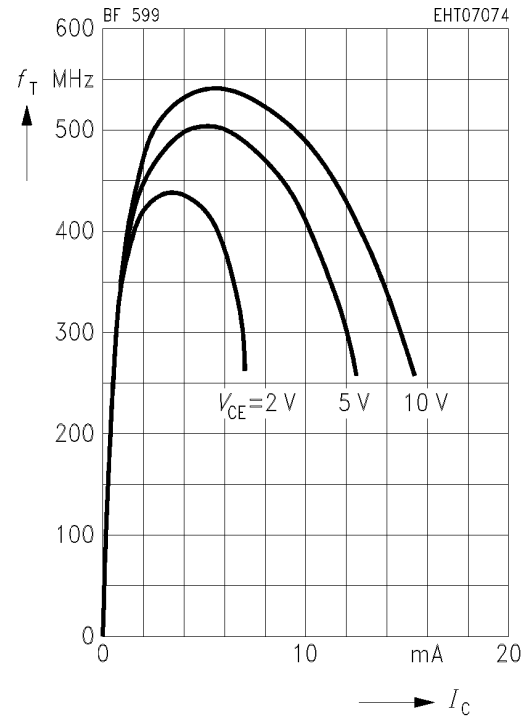

**Collector-base capacitance  $C_{cb} = f(V_{CB})$**

$f = 1\text{ MHz}$

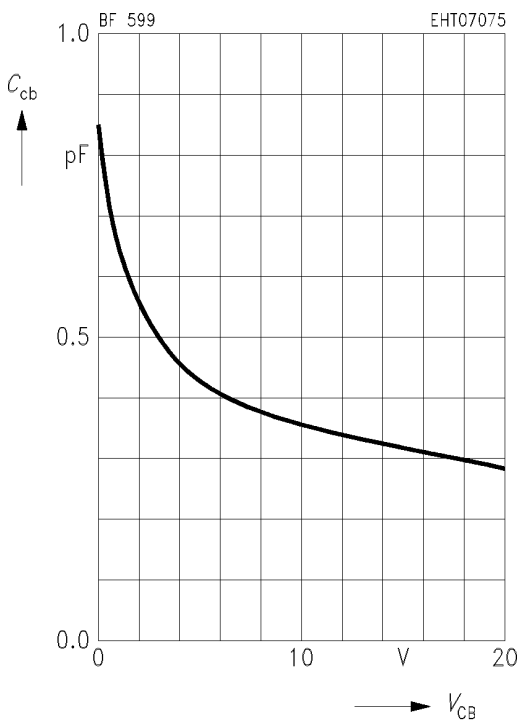

**Forward transfer admittance  $|y_{21e}| = f(I_C)$**

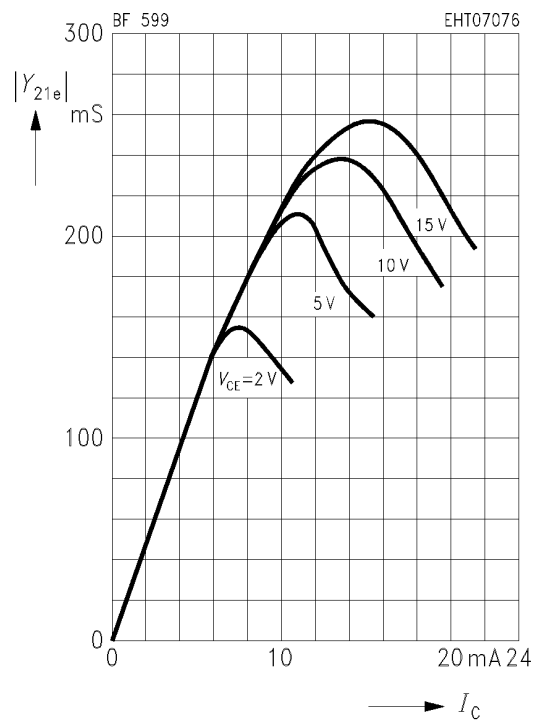

**This datasheet has been downloaded from:**

**[www.EEworld.com.cn](http://www.EEworld.com.cn)**

**Free Download**

**Daily Updated Database**

**100% Free Datasheet Search Site**

**100% Free IC Replacement Search Site**

**Convenient Electronic Dictionary**

**Fast Search System**

**[www.EEworld.com.cn](http://www.EEworld.com.cn)**