

SIPMOS® Power Transistor

BUZ 325

- N channel
- Enhancement mode
- Avalanche-rated

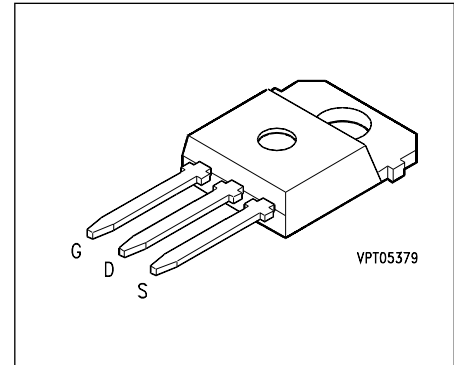

Type	V_{DS}	I_D	$R_{DS(on)}$	Package ¹⁾	Ordering Code
BUZ 325	400 V	12.5 A	0.35 Ω	TO-218 AA	C67078-S3118-A2

Maximum Ratings

Parameter	Symbol	Values	Unit
Continuous drain current, $T_C = 27\text{ °C}$	I_D	12.5	A
Pulsed drain current, $T_C = 25\text{ °C}$	$I_{D\text{ puls}}$	50	
Avalanche current, limited by $T_{j\text{ max}}$	I_{AR}	12.5	
Avalanche energy, periodic limited by $T_{j\text{ (max)}}$	E_{AR}	14	mJ
Avalanche energy, single pulse $I_D = 12.5\text{ A}$, $V_{DD} = 50\text{ V}$, $R_{GS} = 25\text{ }\Omega$ $L = 7.50\text{ mH}$, $T_j = 25\text{ °C}$	E_{AS}	670	
Gate-source voltage	V_{GS}	± 20	V
Power dissipation, $T_C = 25\text{ °C}$	P_{tot}	125	W
Operating and storage temperature range	T_j, T_{stg}	- 55 ... + 150	$^{\circ}\text{C}$

Thermal resistance, chip-case	$R_{th\text{ JC}}$	≤ 1.0	K/W
DIN humidity category, DIN 40 040	–	E	–
IEC climatic category, DIN IEC 68-1	–	55/150/56	

1) See chapter Package Outlines.

Electrical Characteristics

at $T_j = 25\text{ °C}$, unless otherwise specified.

Parameter	Symbol	Values			Unit
		min.	typ.	max.	

Static characteristics

Drain-source breakdown voltage $V_{GS} = 0\text{ V}, I_D = 0.25\text{ mA}$	$V_{(BR)DSS}$	400	–	–	V
Gate threshold voltage $V_{GS} = V_{DS}, I_D = 1\text{ mA}$	$V_{GS(th)}$	2.1	3.0	4.0	
Zero gate voltage drain current $V_{DS} = 400\text{ V}, V_{GS} = 0\text{ V}$ $T_j = 25\text{ °C}$ $T_j = 125\text{ °C}$	I_{DSS}	– –	0.1 10	1.0 100	μA
Gate-source leakage current $V_{GS} = 20\text{ V}, V_{DS} = 0\text{ V}$	I_{GSS}	–	10	100	nA
Drain-source on-resistance $V_{GS} = 10\text{ V}, I_D = 8.0\text{ A}$	$R_{DS(on)}$	–	0.28	0.35	Ω

Dynamic characteristics

Forward transconductance $V_{DS} \geq 2 \times I_D \times R_{DS(on)max}, I_D = 8.0\text{ A}$	g_{fs}	8.0	9.8	–	S
Input capacitance $V_{GS} = 0\text{ V}, V_{DS} = 25\text{ V}, f = 1\text{ MHz}$	C_{iss}	–	1900	2500	pF
Output capacitance $V_{GS} = 0\text{ V}, V_{DS} = 25\text{ V}, f = 1\text{ MHz}$	C_{oss}	–	260	400	
Reverse transfer capacitance $V_{GS} = 0\text{ V}, V_{DS} = 25\text{ V}, f = 1\text{ MHz}$	C_{rss}	–	110	170	
Turn-on time $t_{on}, (t_{on} = t_{d(on)} + t_r)$ $V_{DD} = 30\text{ V}, V_{GS} = 10\text{ V}, I_D = 3.0\text{ A}, R_{GS} = 50\text{ }\Omega$	$t_{d(on)}$	–	30	45	ns
	t_r	–	90	135	
Turn-off time $t_{off}, (t_{off} = t_{d(off)} + t_f)$ $V_{DD} = 30\text{ V}, V_{GS} = 10\text{ V}, I_D = 3.0\text{ A}, R_{GS} = 50\text{ }\Omega$	$t_{d(off)}$	–	350	465	
	t_f	–	100	135	

Electrical Characteristics (cont'd)

at $T_j = 25\text{ °C}$, unless otherwise specified.

Parameter	Symbol	Values			Unit
		min.	typ.	max.	

Reverse diode

Continuous reverse drain current $T_C = 25\text{ °C}$	I_S	–	–	12.5	A
Pulsed reverse drain current $T_C = 25\text{ °C}$	I_{SM}	–	–	50	
Diode forward on-voltage $I_S = 25\text{ A}$, $V_{GS} = 0\text{ V}$	V_{SD}	–	1.0	1.5	V
Reverse recovery time $V_R = 100\text{ V}$, $I_F = I_S$, $di_F / dt = 100\text{ A}/\mu\text{s}$	t_{rr}	–	450	–	ns
Reverse recovery charge $V_R = 100\text{ V}$, $I_F = I_S$, $di_F / dt = 100\text{ A}/\mu\text{s}$	Q_{rr}	–	6.8	–	μC

Characteristics at $T_j = 25^\circ\text{C}$, unless otherwise specified.

Total power dissipation

$$P_{\text{tot}} = f(T_C)$$

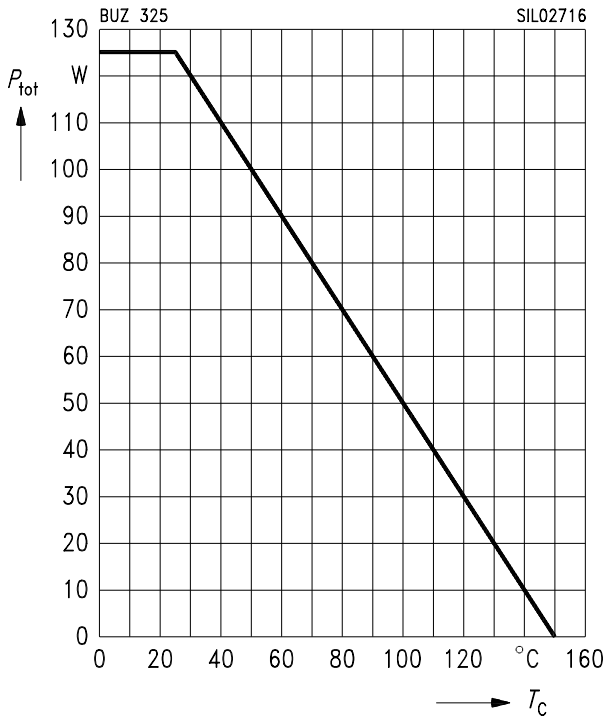

Typ. output characteristics

$$I_D = f(V_{\text{DS}})$$

parameter: $t_p = 80 \mu\text{s}$

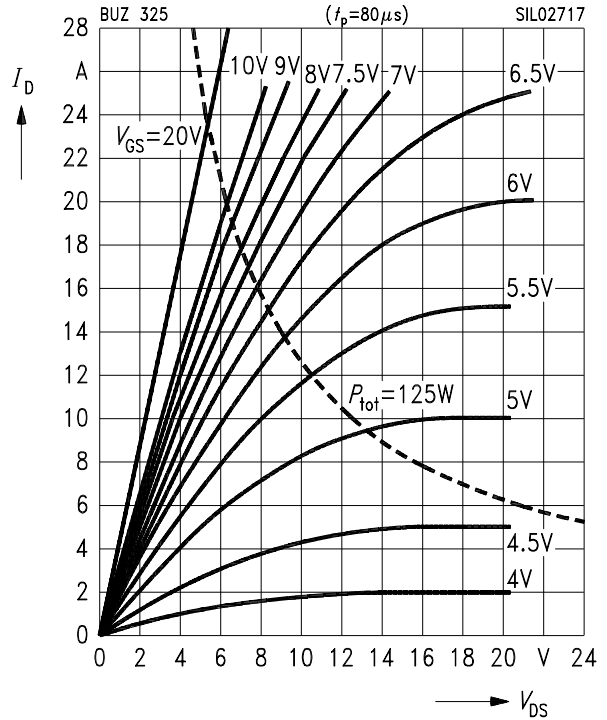

Safe operating area

$$I_D = f(V_{\text{DS}})$$

parameter: $D = 0.01$, $T_C = 25^\circ\text{C}$

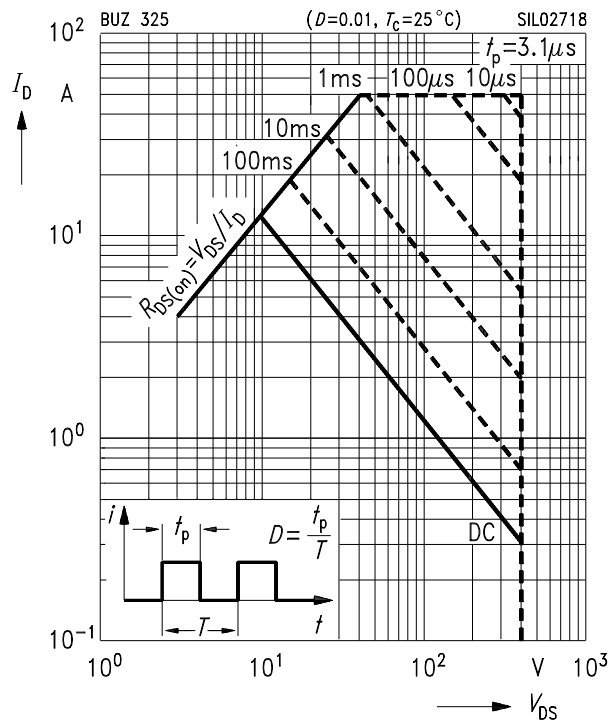

Typ. transfer characteristics

$$I_D = f(V_{\text{GS}})$$

parameter: $t_p = 80 \mu\text{s}$, $V_{\text{DS}} = 25 \text{ V}$

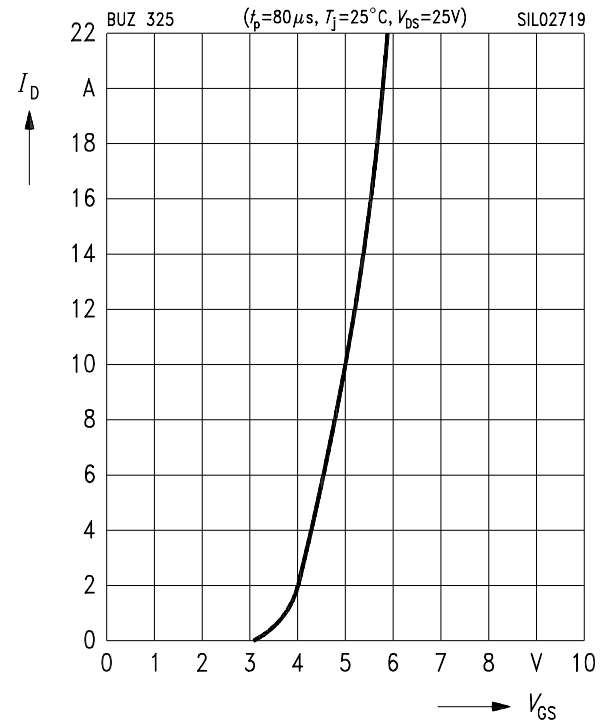

Typ. drain-source on-resistance

$R_{DS(on)} = f(I_D)$

parameter: V_{GS}

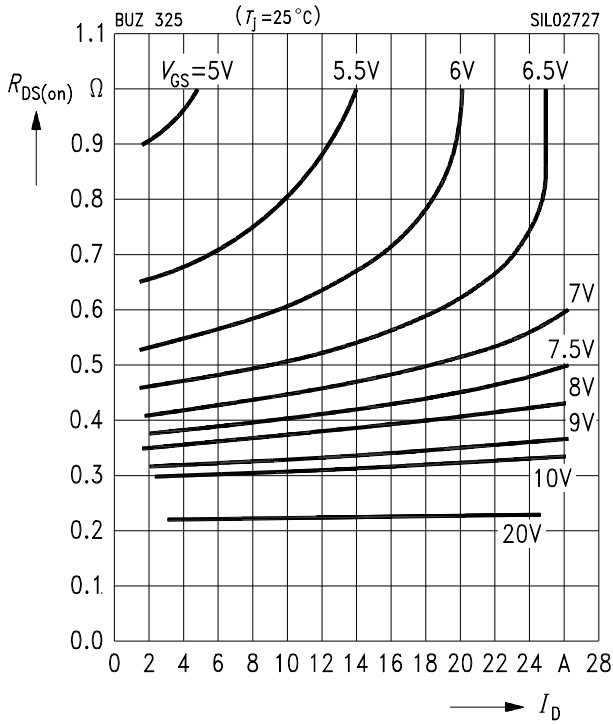

Drain-source on-resistance

$R_{DS(on)} = f(T_j)$

parameter: $I_D = 8.0\text{ A}$, $V_{GS} = 10\text{ V}$, (spread)

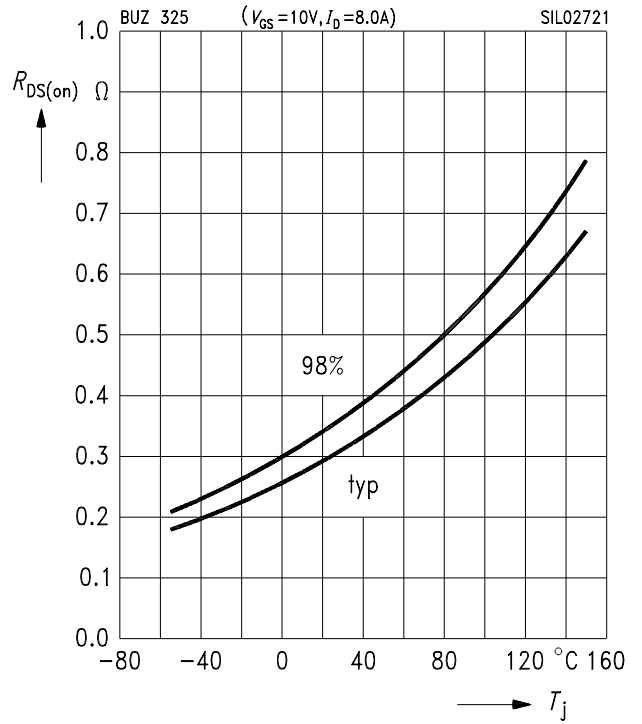

Typ. forward transconductance

$g_{fs} = f(I_D)$

parameter: $t_p = 80\ \mu\text{s}$

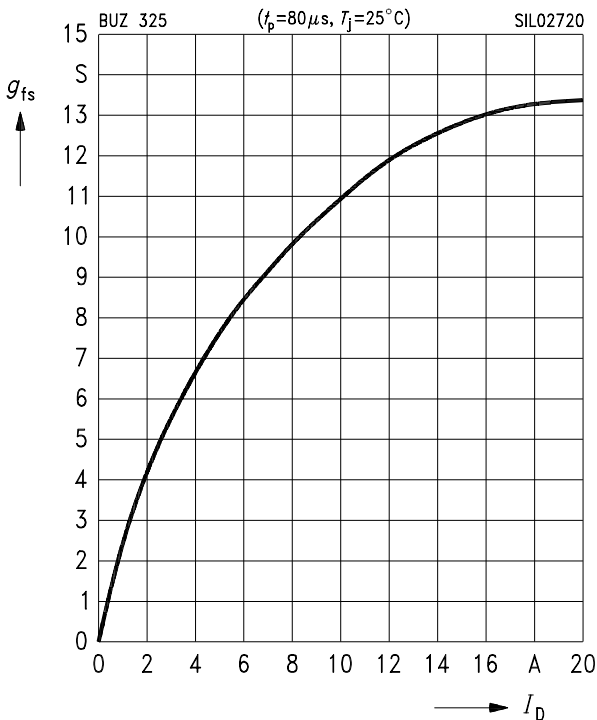

Gate threshold voltage

$V_{GS(th)} = f(T_j)$

parameter: $V_{GS} = V_{DS}$, $I_D = 1\text{ mA}$, (spread)

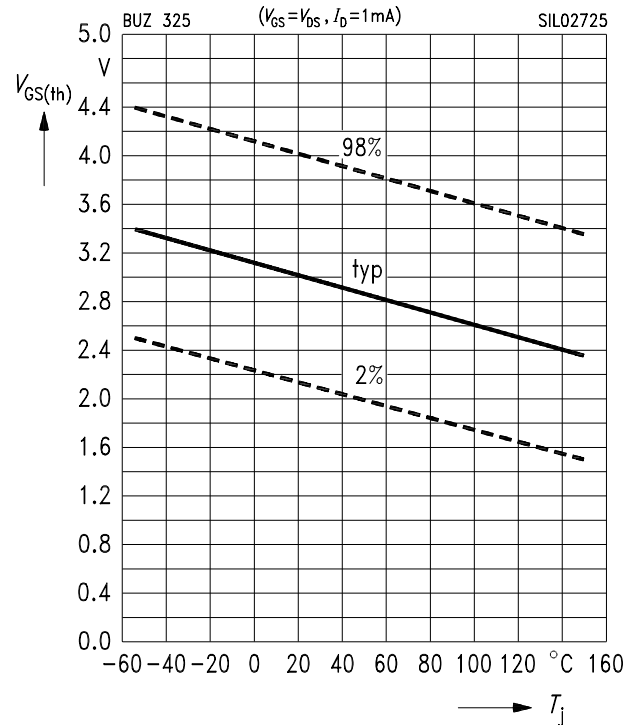

Typ. capacitances

$C = f(V_{DS})$

parameter: $V_{GS} = 0\text{ V}, f = 1\text{ MHz}$

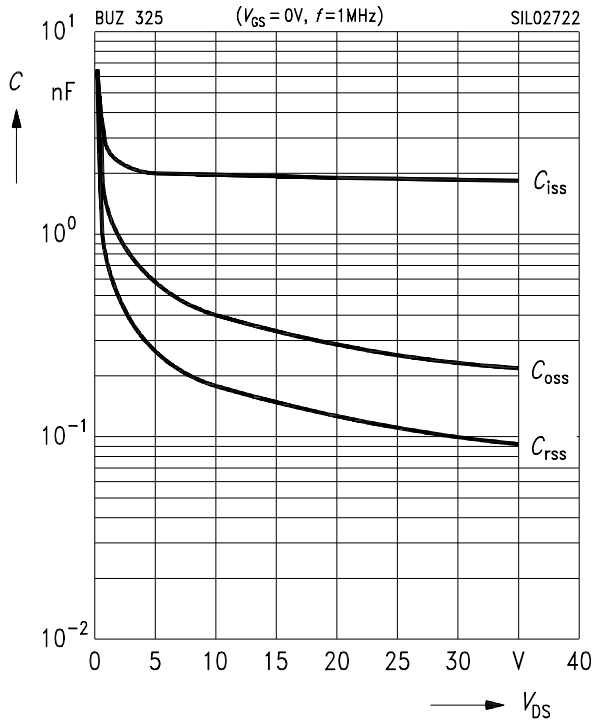

Drain current

$I_D = f(T_C)$

parameter: $V_{GS} \geq 10\text{ V}$

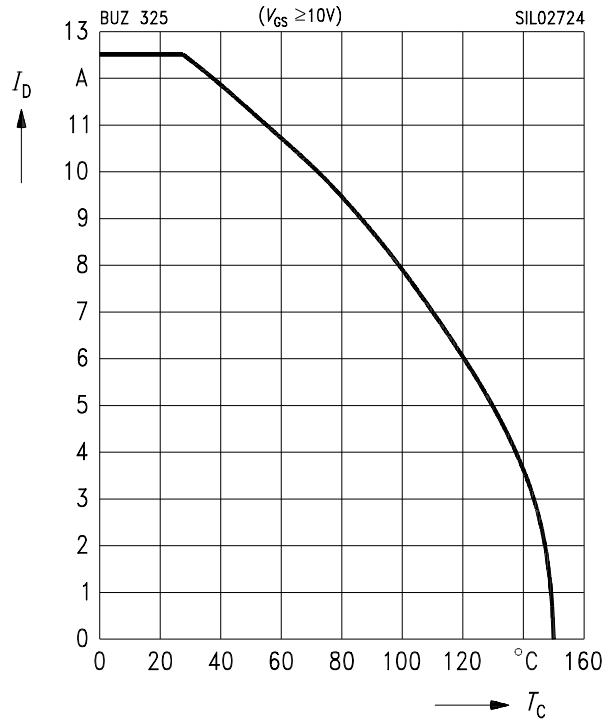

Forward characteristics of reverse diode

$I_F = f(V_{SD})$

parameter: $T_j, t_p = 80\ \mu\text{s}$

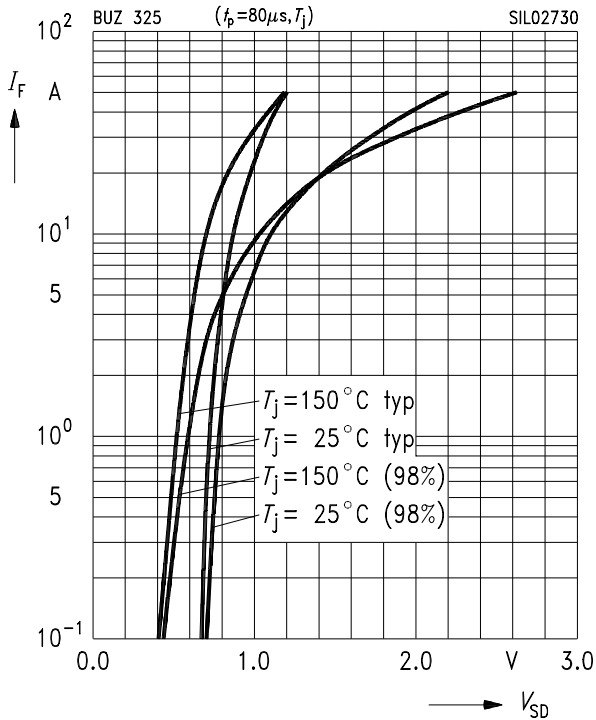

Avalanche energy $E_{AS} = f(T_j)$

parameter: $I_D = 12.5\text{ A}, V_{DD} = 50\text{ V}$

$R_{GS} = 25\ \Omega, L = 7.50\text{ mH}$

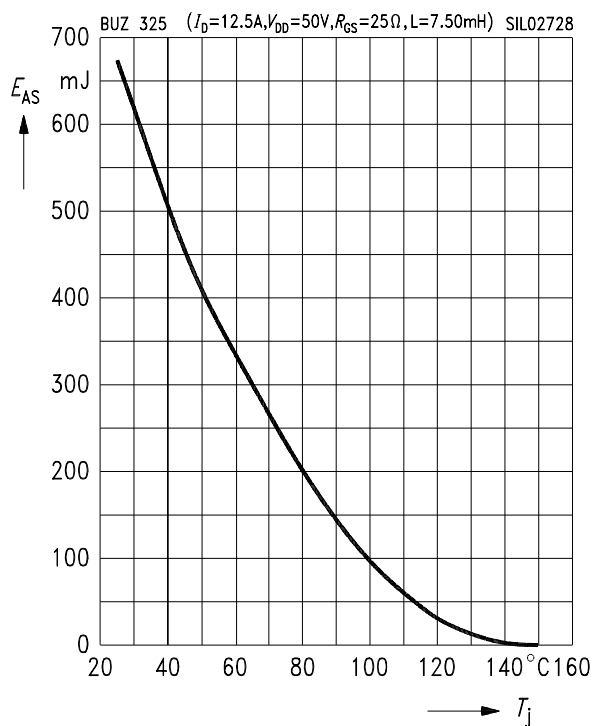

Transient thermal impedance

$$Z_{thJC} = f(t_p)$$

parameter: $D = t_p / T$

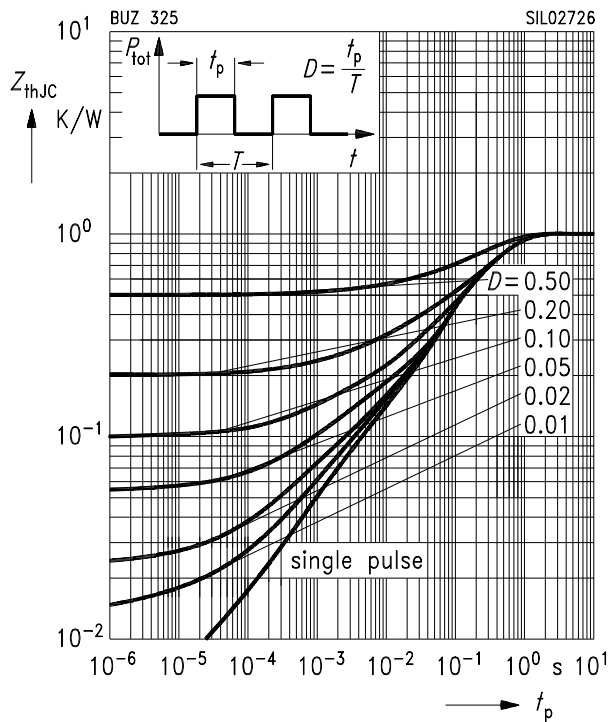

Typ. gate charge

$$V_{GS} = f(Q_{Gate})$$

parameter: $I_{D\ puls} = 21.0\ A$

