

### SIPMOS<sup>®</sup> Power Transistor

- N channel
- Enhancement mode
- Avalanche-rated

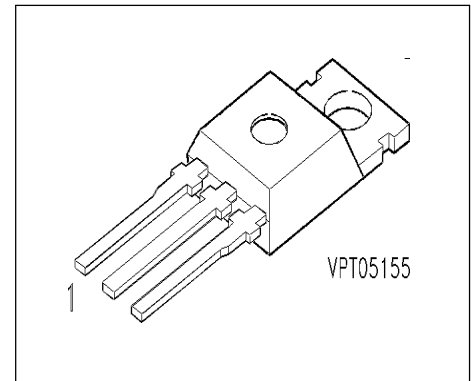

| Pin 1 | Pin 2 | Pin 3 |
|-------|-------|-------|
| G     | D     | S     |

| Type   | V <sub>DS</sub> | I <sub>D</sub> | R <sub>DS(on)</sub> | Package   | Ordering Code   |
|--------|-----------------|----------------|---------------------|-----------|-----------------|
| BUZ 72 | 100 V           | 10 A           | 0.2 Ω               | TO-220 AB | C67078-S1313-A2 |

#### Maximum Ratings

| Parameter   | Symbol      | Values        | Unit |
|---|-------------|---------------|------|
| Continuous drain current<br>$T_C = 25\text{ °C}$  | $I_D$       | 10            | A    |
| Pulsed drain current<br>$T_C = 25\text{ °C}$  | $I_{Dpuls}$ | 40            |      |
| Avalanche current, limited by $T_{jmax}$  | $I_{AR}$    | 10            |      |
| Avalanche energy, periodic limited by $T_{jmax}$  | $E_{AR}$    | 7.9           | mJ   |
| Avalanche energy, single pulse<br>$I_D = 10\text{ A}$ , $V_{DD} = 25\text{ V}$ , $R_{GS} = 25\text{ Ω}$<br>$L = 885\text{ μH}$ , $T_j = 25\text{ °C}$ | $E_{AS}$    | 59            |      |
| Gate source voltage   | $V_{GS}$    | ± 20          | V    |
| Power dissipation<br>$T_C = 25\text{ °C}$   | $P_{tot}$   | 40            | W    |
| Operating temperature   | $T_j$       | -55 ... + 150 | °C   |
| Storage temperature   | $T_{stg}$   | -55 ... + 150 |      |
| Thermal resistance, chip case   | $R_{thJC}$  | ≤ 3.1         | K/W  |
| Thermal resistance, chip to ambient   | $R_{thJA}$  | 75            |      |
| DIN humidity category, DIN 40 040   |             | E             |      |
| IEC climatic category, DIN IEC 68-1   |             | 55 / 150 / 56 |      |

**Electrical Characteristics, at  $T_j = 25^\circ\text{C}$ , unless otherwise specified**

| Parameter  | Symbol        | Values |           |          | Unit          |
|--|---------------|--------|-----------|----------|---------------|
|  |               | min.   | typ.      | max.     |               |
| <b>Static Characteristics</b>  |               |        |           |          |               |
| Drain- source breakdown voltage<br>$V_{GS} = 0\text{ V}, I_D = 0.25\text{ mA}, T_j = 25\text{ }^\circ\text{C}$   | $V_{(BR)DSS}$ | 100    | -         | -        | V             |
| Gate threshold voltage<br>$V_{GS}=V_{DS}, I_D = 1\text{ mA}$   | $V_{GS(th)}$  | 2.1    | 3         | 4        |               |
| Zero gate voltage drain current<br>$V_{DS} = 100\text{ V}, V_{GS} = 0\text{ V}, T_j = 25\text{ }^\circ\text{C}$<br>$V_{DS} = 100\text{ V}, V_{GS} = 0\text{ V}, T_j = 125\text{ }^\circ\text{C}$ | $I_{DSS}$     | -      | 0.1<br>10 | 1<br>100 | $\mu\text{A}$ |
| Gate-source leakage current<br>$V_{GS} = 20\text{ V}, V_{DS} = 0\text{ V}$   | $I_{GSS}$     | -      | 10        | 100      | nA            |
| Drain-Source on-resistance<br>$V_{GS} = 10\text{ V}, I_D = 6\text{ A}$   | $R_{DS(on)}$  | -      | 0.15      | 0.2      | $\Omega$      |

**Electrical Characteristics, at  $T_j = 25^\circ\text{C}$ , unless otherwise specified**

| Parameter  | Symbol       | Values |      |      | Unit |
|--|--------------|--------|------|------|------|
|  |              | min.   | typ. | max. |      |
| <b>Dynamic Characteristics</b>   |              |        |      |      |      |
| Transconductance<br>$V_{DS} \geq 2 \cdot I_D \cdot R_{DS(on)max}, I_D = 6 \text{ A}$                             | $g_{fs}$     | 3      | 4.3  | -    | S    |
| Input capacitance<br>$V_{GS} = 0 \text{ V}, V_{DS} = 25 \text{ V}, f = 1 \text{ MHz}$                            | $C_{iss}$    | -      | 400  | 530  | pF   |
| Output capacitance<br>$V_{GS} = 0 \text{ V}, V_{DS} = 25 \text{ V}, f = 1 \text{ MHz}$                           | $C_{oss}$    | -      | 120  | 180  |      |
| Reverse transfer capacitance<br>$V_{GS} = 0 \text{ V}, V_{DS} = 25 \text{ V}, f = 1 \text{ MHz}$                 | $C_{rss}$    | -      | 70   | 105  |      |
| Turn-on delay time<br>$V_{DD} = 30 \text{ V}, V_{GS} = 10 \text{ V}, I_D = 3 \text{ A}$<br>$R_{GS} = 50 \Omega$  | $t_{d(on)}$  | -      | 10   | 15   | ns   |
| Rise time<br>$V_{DD} = 30 \text{ V}, V_{GS} = 10 \text{ V}, I_D = 3 \text{ A}$<br>$R_{GS} = 50 \Omega$           | $t_r$        | -      | 45   | 70   |      |
| Turn-off delay time<br>$V_{DD} = 30 \text{ V}, V_{GS} = 10 \text{ V}, I_D = 3 \text{ A}$<br>$R_{GS} = 50 \Omega$ | $t_{d(off)}$ | -      | 55   | 75   |      |
| Fall time<br>$V_{DD} = 30 \text{ V}, V_{GS} = 10 \text{ V}, I_D = 3 \text{ A}$<br>$R_{GS} = 50 \Omega$           | $t_f$        | -      | 40   | 55   |      |

**Electrical Characteristics, at  $T_j = 25^\circ\text{C}$ , unless otherwise specified**

| Parameter   | Symbol   | Values |      |      | Unit          |
|---|----------|--------|------|------|---------------|
|   |          | min.   | typ. | max. |               |
| <b>Reverse Diode</b>  |          |        |      |      |               |
| Inverse diode continuous forward current<br>$T_C = 25^\circ\text{C}$                          | $I_S$    | -      | -    | 10   | A             |
| Inverse diode direct current, pulsed<br>$T_C = 25^\circ\text{C}$                              | $I_{SM}$ | -      | -    | 40   |               |
| Inverse diode forward voltage<br>$V_{GS} = 0\text{ V}, I_F = 20\text{ A}$                     | $V_{SD}$ | -      | 1.4  | 1.6  | V             |
| Reverse recovery time<br>$V_R = 30\text{ V}, I_F = I_S, di_F/dt = 100\text{ A}/\mu\text{s}$   | $t_{rr}$ | -      | 170  | -    | ns            |
| Reverse recovery charge<br>$V_R = 30\text{ V}, I_F = I_S, di_F/dt = 100\text{ A}/\mu\text{s}$ | $Q_{rr}$ | -      | 0.3  | -    | $\mu\text{C}$ |

### Power dissipation

$$P_{\text{tot}} = f(T_C)$$

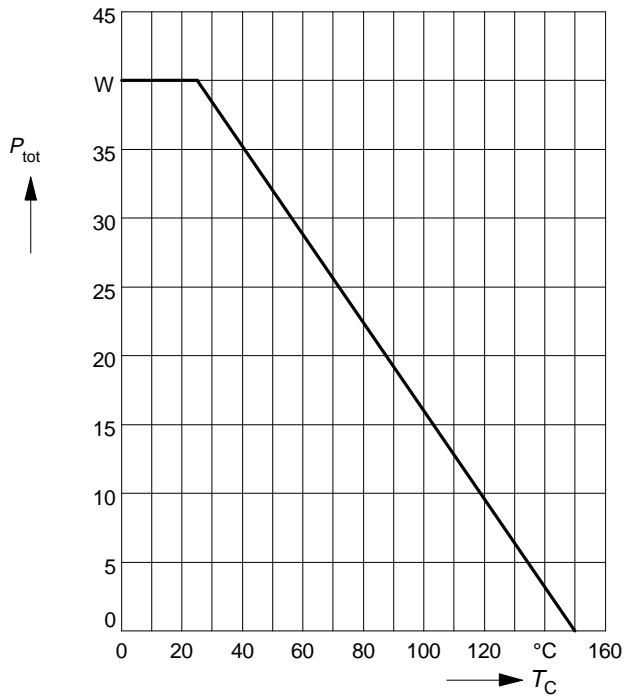

### Drain current

$$I_D = f(T_C)$$

parameter:  $V_{\text{GS}} \geq 10 \text{ V}$

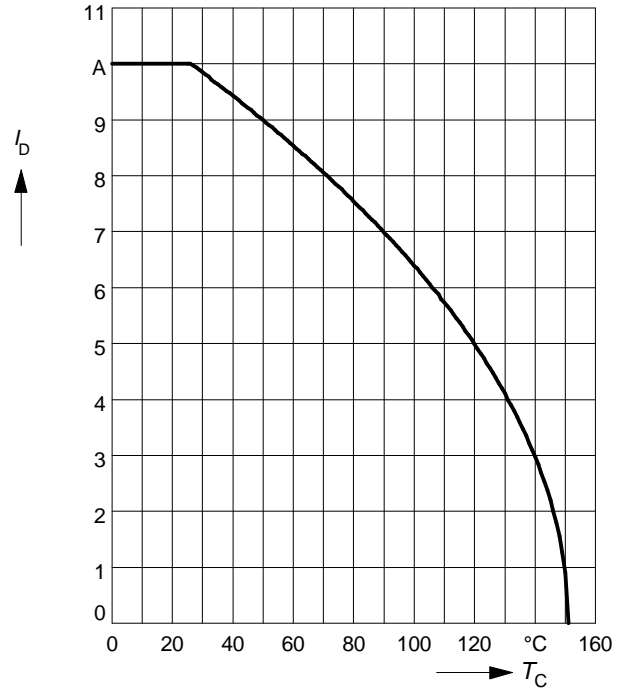

### Safe operating area

$$I_D = f(V_{\text{DS}})$$

parameter:  $D = 0.01$ ,  $T_C = 25^\circ\text{C}$

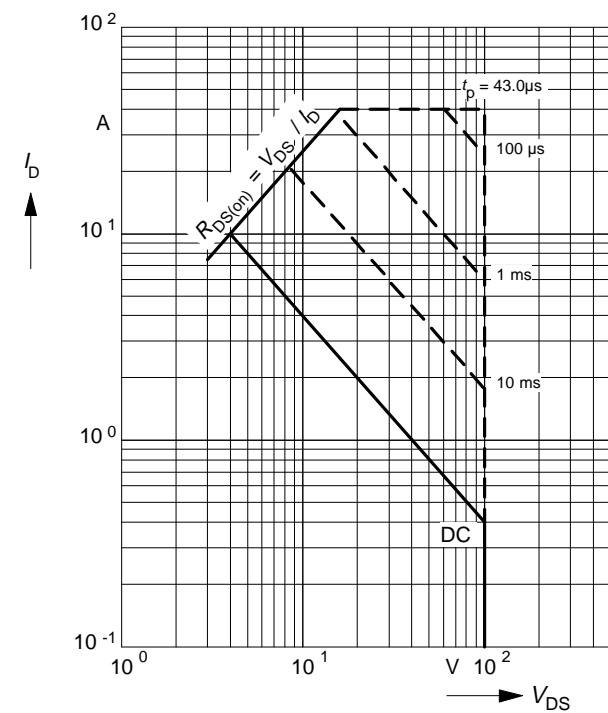

### Transient thermal impedance

$$Z_{\text{thJC}} = f(t_p)$$

parameter:  $D = t_p / T$

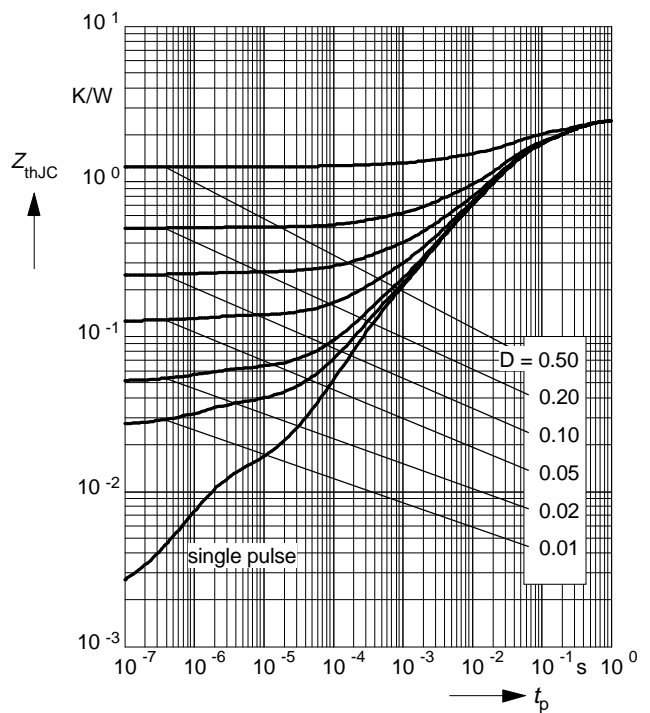

### Typ. output characteristics

$$I_D = f(V_{DS})$$

parameter:  $t_p = 80 \mu s$

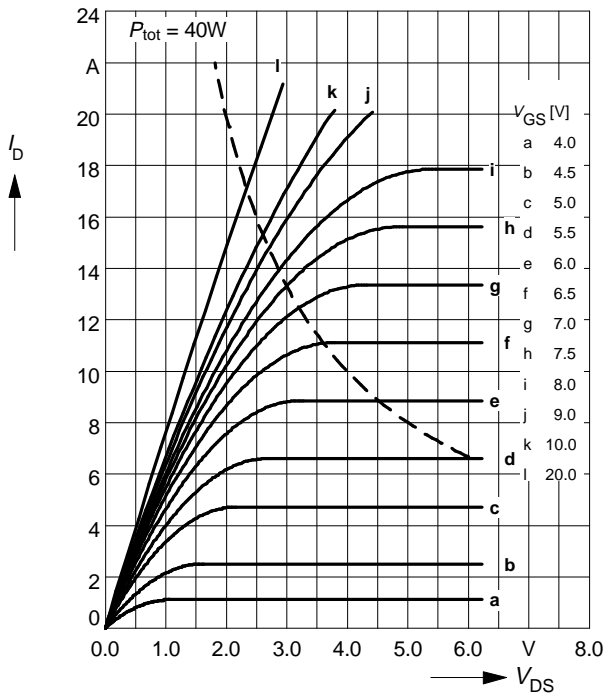

### Typ. drain-source on-resistance

$$R_{DS(on)} = f(I_D)$$

parameter:  $V_{GS}$

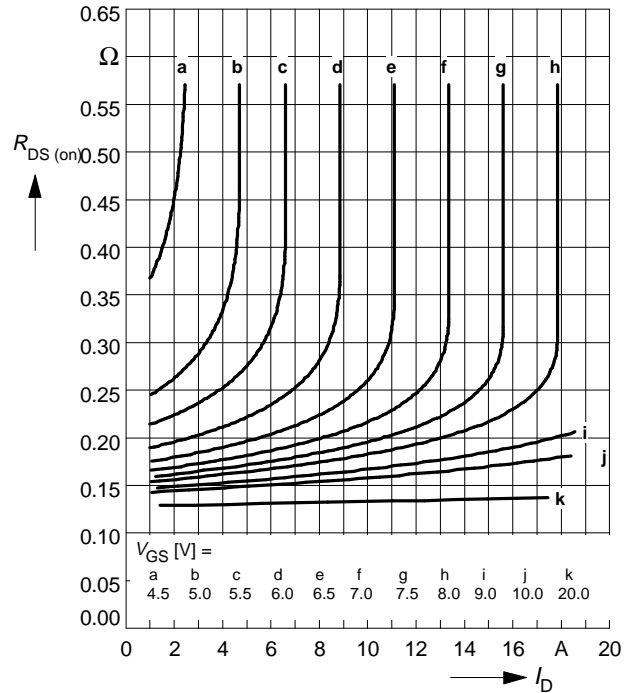

### Typ. transfer characteristics $I_D = f(V_{GS})$

parameter:  $t_p = 80 \mu s$

$$V_{DS} \geq 2 \times I_D \times R_{DS(on)max}$$

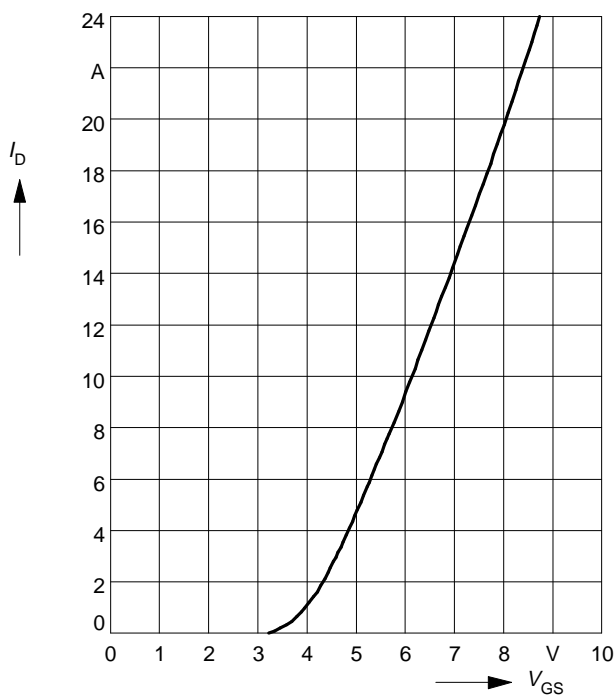

### Typ. forward transconductance $g_{fs} = f(I_D)$

parameter:  $t_p = 80 \mu s$ ,

$$V_{DS} \geq 2 \times I_D \times R_{DS(on)max}$$

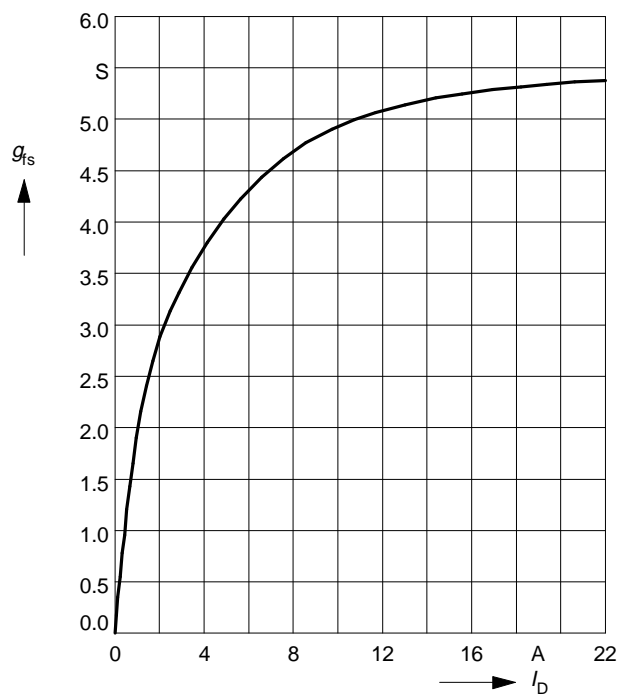

### Drain-source on-resistance

$$R_{DS(on)} = f(T_j)$$

parameter:  $I_D = 6\text{ A}$ ,  $V_{GS} = 10\text{ V}$

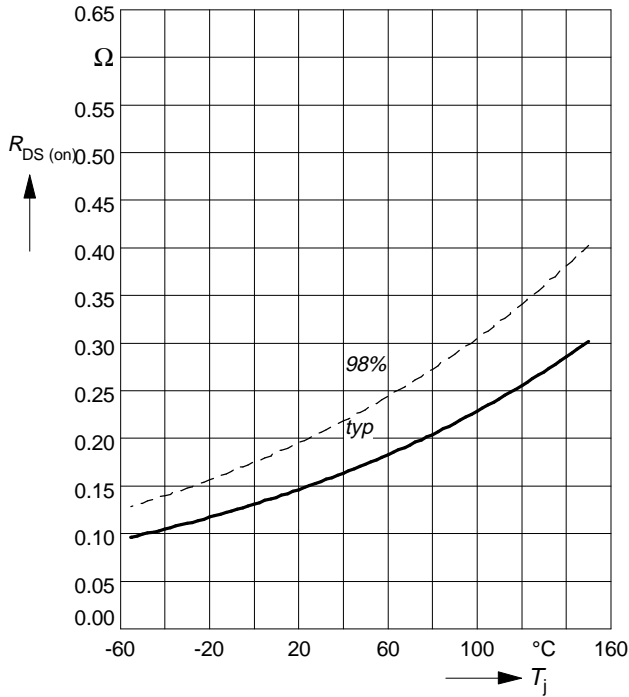

### Gate threshold voltage

$$V_{GS(th)} = f(T_j)$$

parameter:  $V_{GS} = V_{DS}$ ,  $I_D = 1\text{ mA}$

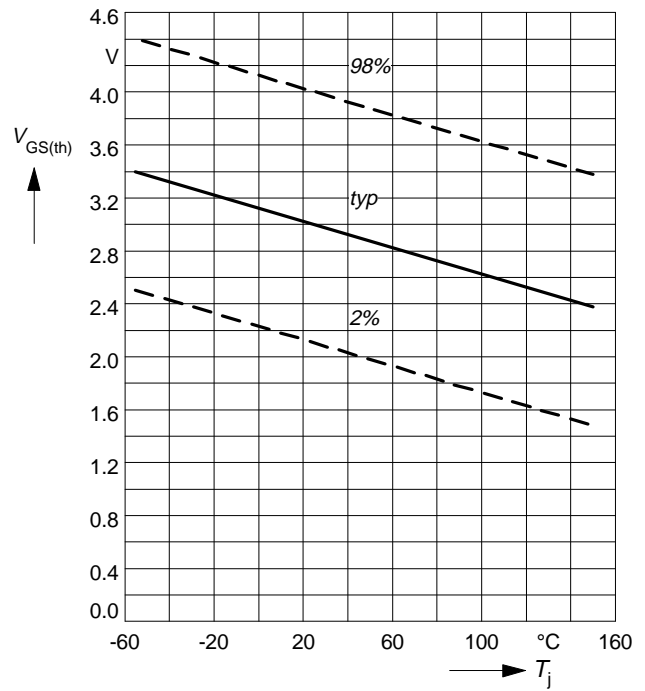

### Typ. capacitances

$$C = f(V_{DS})$$

parameter:  $V_{GS} = 0\text{ V}$ ,  $f = 1\text{ MHz}$

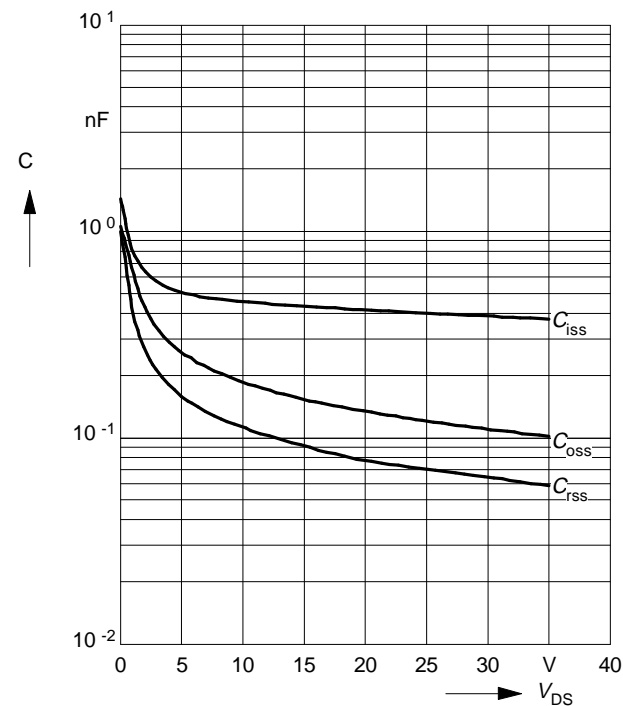

### Forward characteristics of reverse diode

$$I_F = f(V_{SD})$$

parameter:  $T_j$ ,  $t_p = 80\text{ }\mu\text{s}$

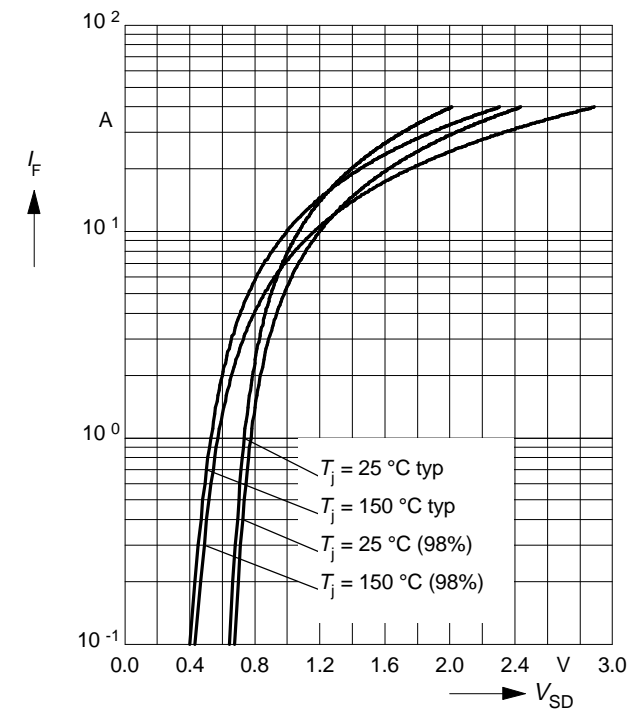

### Avalanche energy $E_{AS} = f(T_j)$

parameter:  $I_D = 10 \text{ A}$ ,  $V_{DD} = 25 \text{ V}$

$R_{GS} = 25 \Omega$ ,  $L = 885 \mu\text{H}$

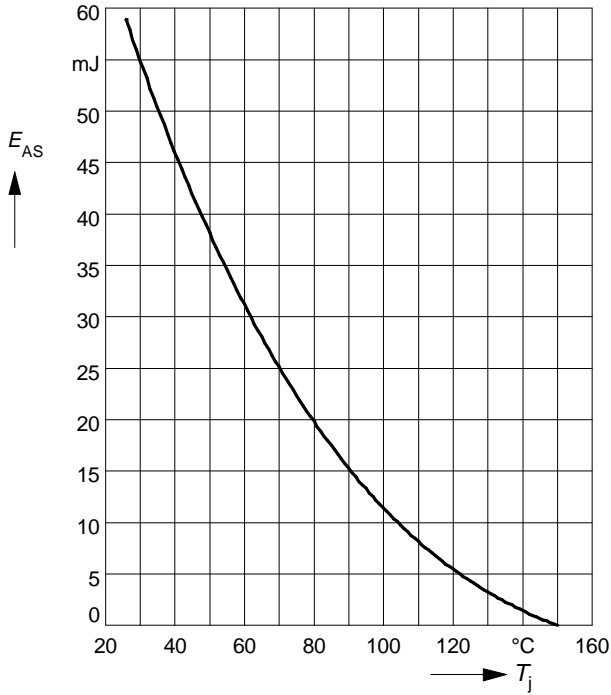

### Typ. gate charge $V_{GS} = f(Q_{Gate})$

$V_{GS} = f(Q_{Gate})$

parameter:  $I_{D \text{ puls}} = 15 \text{ A}$

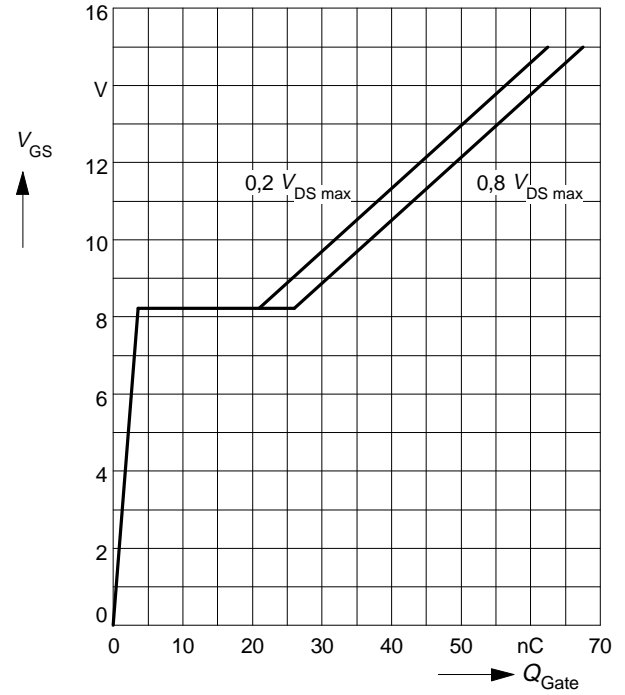

### Drain-source breakdown voltage $V_{(BR)DSS} = f(T_j)$

$V_{(BR)DSS} = f(T_j)$

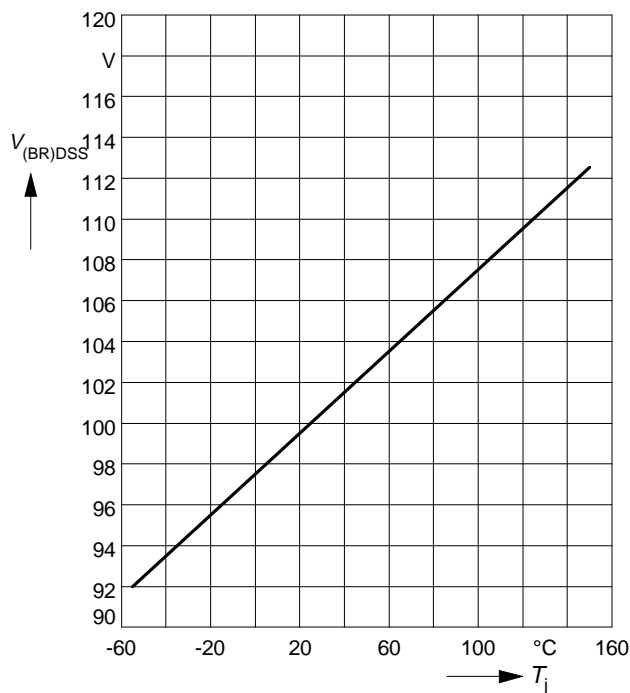



## Package Outlines

TO-220 AB

Dimension in mm



GPT05155

- 1) punch direction, burr max. 0.04
- 2) dip tinning
- 3) max. 14.5 by dip tinning press burr max. 0.05