

FS10KM-10

HIGH-SPEED SWITCHING USE

FS10KM-10



- V_{DSS} 500V
- r_{DS (ON)} (MAX) 0.90Ω
- I_D 10A
- V_{iso} 2000V

OUTLINE DRAWING

Dimensions in mm

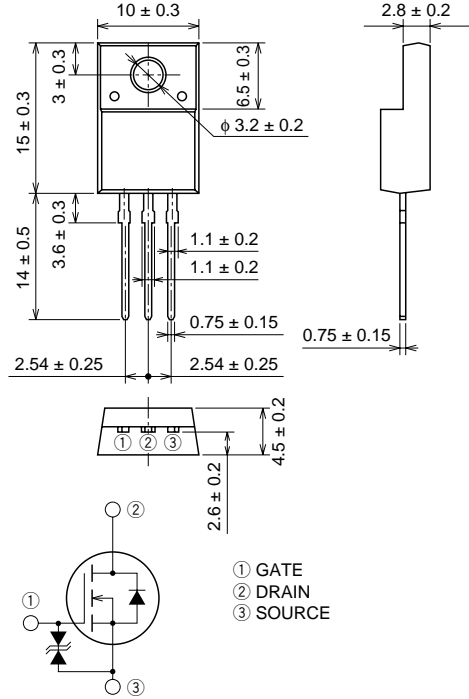

TO-220FN

APPLICATION

SMPS, DC-DC Converter, battery charger, power supply of printer, copier, HDD, FDD, TV, VCR, personal computer etc.

MAXIMUM RATINGS (T_c = 25°C)

| Symbol | Parameter | Conditions | Ratings | Unit |
|------------------|---------------------------|----------------------------------|------------|------------------|
| V _{DSS} | Drain-source voltage | V _{GS} = 0V | 500 | V |
| V _{GSS} | Gate-source voltage | V _{DS} = 0V | ±30 | V |
| I _D | Drain current | | 10 | A |
| I _{DM} | Drain current (Pulsed) | | 30 | A |
| P _D | Maximum power dissipation | | 35 | W |
| T _{ch} | Channel temperature | | -55 ~ +150 | °C |
| T _{stg} | Storage temperature | | -55 ~ +150 | °C |
| V _{iso} | Isolation voltage | AC for 1minute, Terminal to case | 2000 | V _{rms} |
| — | Weight | Typical value | 2.0 | g |

FS10KM-10

HIGH-SPEED SWITCHING USE

ELECTRICAL CHARACTERISTICS (T_{ch} = 25°C)

| Symbol | Parameter | Test conditions | Limits | | | Unit |
|------------------------|----------------------------------|--|---|------|------|------|
| | | | Min. | Typ. | Max. | |
| V (BR) DSS | Drain-source breakdown voltage | I _D = 1mA, V _{GS} = 0V | 500 | — | — | V |
| V (BR) GSS | Gate-source breakdown voltage | I _G = ±100μA, V _{DS} = 0V | ±30 | — | — | V |
| I _{GSS} | Gate-source leakage current | V _{GS} = ±25V, V _{DS} = 0V | — | — | ±10 | μA |
| I _{DSS} | Drain-source leakage current | V _{DS} = 500V, V _{GS} = 0V | — | — | 1 | mA |
| V _{GS} (th) | Gate-source threshold voltage | I _D = 1mA, V _{DS} = 10V | 2 | 3 | 4 | V |
| r _{DS} (ON) | Drain-source on-state resistance | I _D = 5A, V _{GS} = 10V | — | 0.70 | 0.90 | Ω |
| V _{DS} (ON) | Drain-source on-state voltage | I _D = 5A, V _{GS} = 10V | — | 3.5 | 4.5 | V |
| y _{fs} | Forward transfer admittance | I _D = 5A, V _{DS} = 10V | 3.3 | 5.5 | — | S |
| C _{iss} | Input capacitance | V _{DS} = 25V, V _{GS} = 0V, f = 1MHz | — | 1100 | — | pF |
| C _{oss} | Output capacitance | | — | 135 | — | pF |
| C _{rss} | Reverse transfer capacitance | | — | 20 | — | pF |
| t _d (on) | Turn-on delay time | | — | 20 | — | ns |
| t _r | Rise time | V _{DD} = 200V, I _D = 5A, V _{GS} = 10V, R _{GEN} = R _{GS} = 50Ω | — | 30 | — | ns |
| t _d (off) | Turn-off delay time | | — | 95 | — | ns |
| t _f | Fall time | | — | 35 | — | ns |
| V _{SD} | Source-drain voltage | | I _S = 5A, V _{GS} = 0V | — | 1.5 | 2.0 |
| R _{th} (ch-c) | Thermal resistance | Channel to case | — | — | 3.57 | °C/W |

PERFORMANCE CURVES

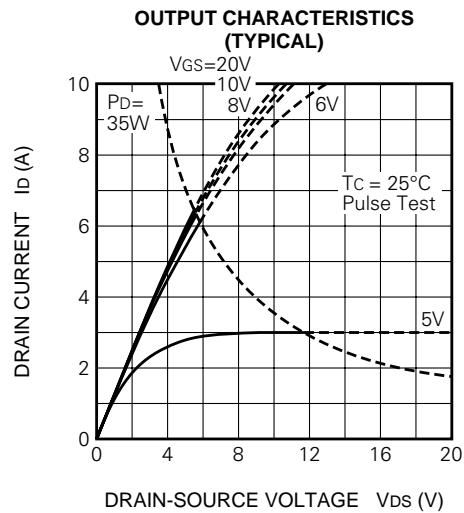
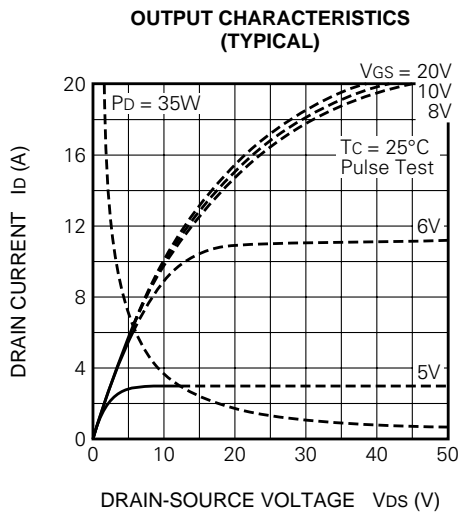
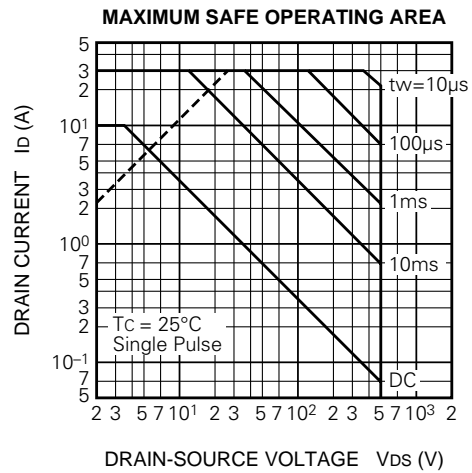
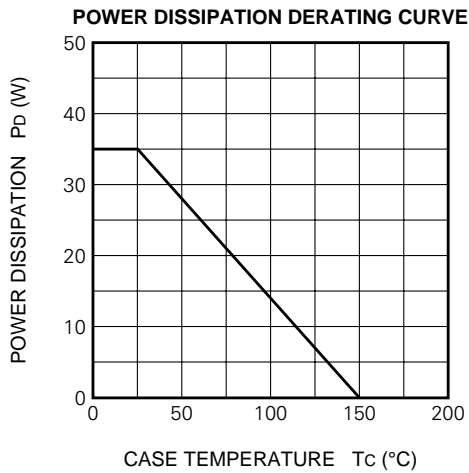

ON-STATE VOLTAGE VS. GATE-SOURCE VOLTAGE (TYPICAL)

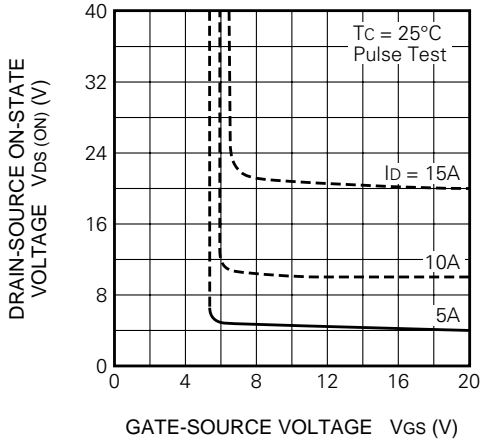

ON-STATE RESISTANCE VS. DRAIN CURRENT (TYPICAL)

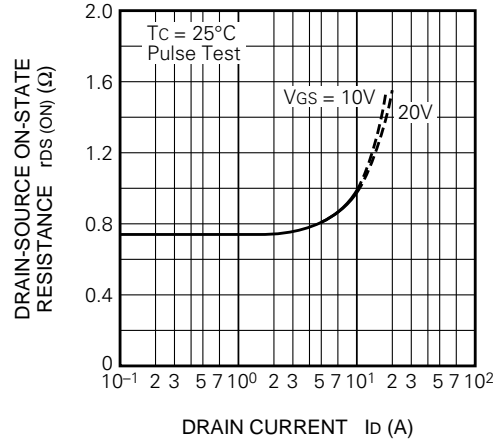

TRANSFER CHARACTERISTICS (TYPICAL)

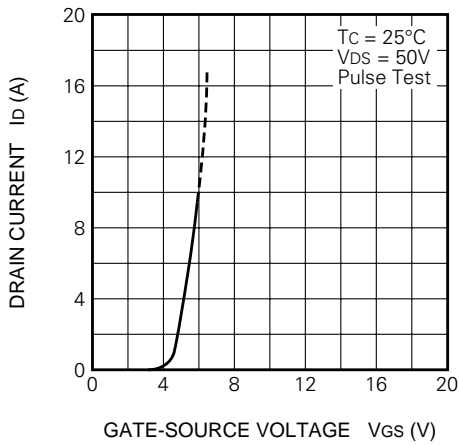

FORWARD TRANSFER ADMITTANCE VS. DRAIN CURRENT (TYPICAL)

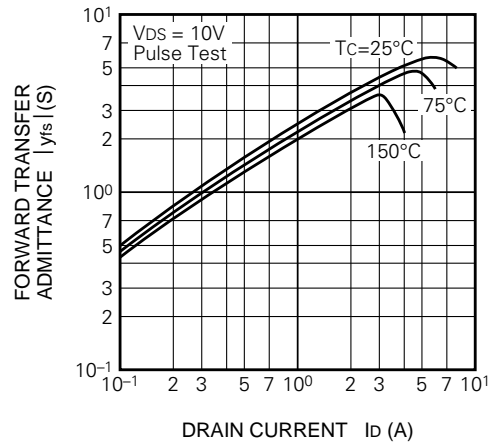

CAPACITANCE VS. DRAIN-SOURCE VOLTAGE (TYPICAL)

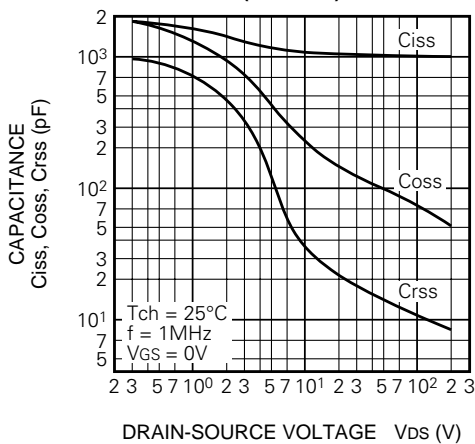

SWITCHING CHARACTERISTICS (TYPICAL)

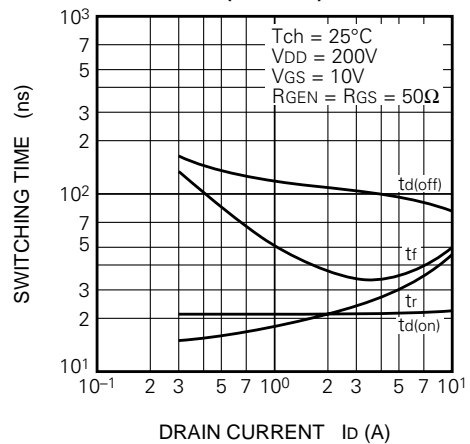

GATE-SOURCE VOLTAGE VS. GATE CHARGE (TYPICAL)

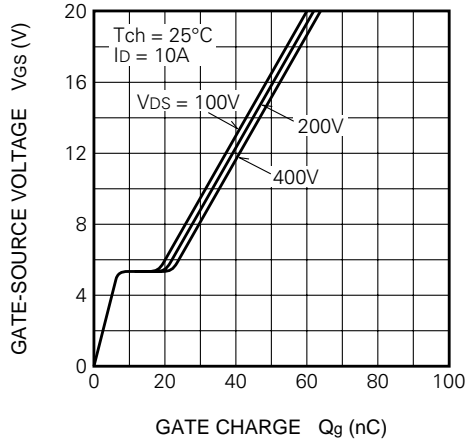

SOURCE-DRAIN DIODE FORWARD CHARACTERISTICS (TYPICAL)

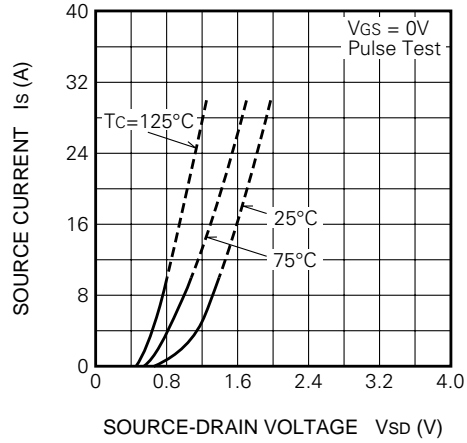

ON-STATE RESISTANCE VS. CHANNEL TEMPERATURE (TYPICAL)

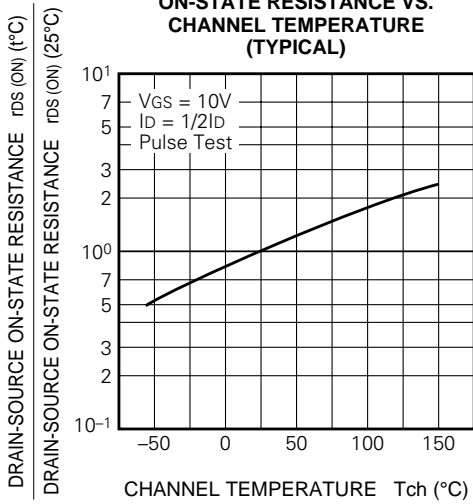

THRESHOLD VOLTAGE VS. CHANNEL TEMPERATURE (TYPICAL)

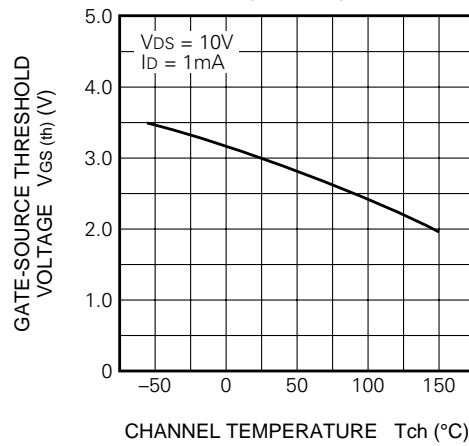

BREAKDOWN VOLTAGE VS. CHANNEL TEMPERATURE (TYPICAL)

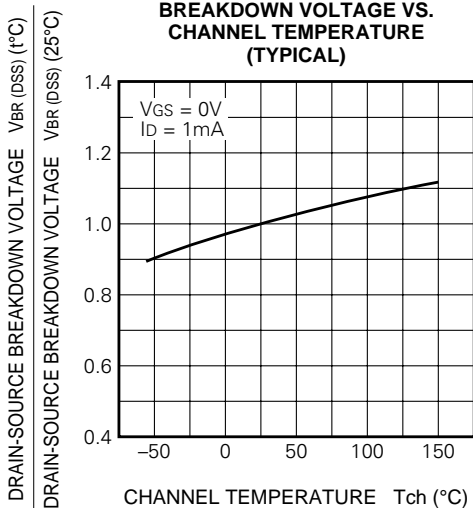

TRANSIENT THERMAL IMPEDANCE CHARACTERISTICS

