

# IRF6617

DirectFET™ Power MOSFET

- Application Specific MOSFETs
- Ideal for CPU Core DC-DC Converters
- Low Conduction Losses
- Low Switching Losses
- Low Profile (<0.7 mm)
- Dual Sided Cooling Compatible
- Compatible with Existing Surface Mount Techniques

$V_{DSS}$	$R_{DS(on)}$ max	$Qg$ (typ.)
30V	8.1m $\Omega$ @ $V_{GS} = 10V$	11nC
	10.3m $\Omega$ @ $V_{GS} = 4.5V$	

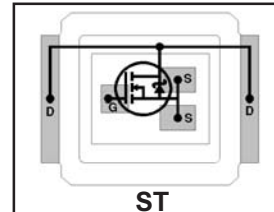

Applicable DirectFET Outline and Substrate Outline (see p.7, 8 for details)

SQ	SX	<b>ST</b>		MQ	MX	MT			
----	----	-----------	--	----	----	----	--	--	--

## Description

The IRF6617 combines the latest HEXFET® power MOSFET silicon technology with advanced DirectFET™ packaging to achieve the lowest on-state resistance in a package that has the footprint of a Micro8™ and only 0.7 mm profile. The DirectFET package is compatible with existing layout geometries used in power applications, PCB assembly equipment and vapor phase, infra-red or convection soldering techniques, when application note AN-1035 is followed regarding the manufacturing methods and processes. The DirectFET package allows dual sided cooling to maximize thermal transfer in power systems, improving previous best thermal resistance by 80%.

The IRF6617 balances both low resistance and low charge along with ultra low package inductance to reduce both conduction and switching losses. The reduced total losses make this product ideal for high efficiency DC-DC converters that power the latest generation of processors operating at higher frequencies. The IRF6617 has been optimized for parameters that are critical in synchronous buck converters including  $R_{DS(on)}$  and gate charge to minimize losses in the control FET socket.

## Absolute Maximum Ratings

	Parameter	Max.	Units
$V_{DS}$	Drain-to-Source Voltage	30	V
$V_{GS}$	Gate-to-Source Voltage	$\pm 20$	
$I_D @ T_C = 25^\circ C$	Continuous Drain Current, $V_{GS} @ 10V$ ⑦	55	A
$I_D @ T_A = 25^\circ C$	Continuous Drain Current, $V_{GS} @ 10V$ ④	14	
$I_D @ T_A = 70^\circ C$	Continuous Drain Current, $V_{GS} @ 10V$ ④	11	
$I_{DM}$	Pulsed Drain Current ①	120	
$P_D @ T_C = 25^\circ C$	Power Dissipation ⑦	42	W
$P_D @ T_A = 25^\circ C$	Power Dissipation ④	2.1	
$P_D @ T_A = 70^\circ C$	Power Dissipation ④	1.4	
$E_{AS}$	Single Pulse Avalanche Energy ②	27	mJ
$I_{AR}$	Avalanche Current ①	12	A
	Linear Derating Factor	0.017	W/°C
$T_J$	Operating Junction and	-40 to + 150	°C
$T_{STG}$	Storage Temperature Range		

## Thermal Resistance

	Parameter	Typ.	Max.	Units
$R_{\theta JA}$	Junction-to-Ambient ④ ⑧	—	58	°C/W
$R_{\theta JA}$	Junction-to-Ambient ⑤ ⑧	12.5	—	
$R_{\theta JA}$	Junction-to-Ambient ⑥ ⑧	20	—	
$R_{\theta JC}$	Junction-to-Case ⑦ ⑧	—	3.0	
$R_{\theta J-PCB}$	Junction-to-PCB Mounted	1.0	—	

Notes ① through ⑧ are on page 2

## Static @ $T_J = 25^\circ\text{C}$ (unless otherwise specified)

	Parameter	Min.	Typ.	Max.	Units	Conditions
$BV_{DSS}$	Drain-to-Source Breakdown Voltage	30	—	—	V	$V_{GS} = 0V, I_D = 250\mu A$
$\Delta BV_{DSS}/\Delta T_J$	Breakdown Voltage Temp. Coefficient	—	25	—	mV/°C	Reference to $25^\circ\text{C}, I_D = 1mA$
$R_{DS(on)}$	Static Drain-to-Source On-Resistance	—	6.2	8.1	mΩ	$V_{GS} = 10V, I_D = 15A$ ③
		—	7.9	10.3		$V_{GS} = 4.5V, I_D = 12A$ ③
$V_{GS(th)}$	Gate Threshold Voltage	1.35	—	2.35	V	$V_{DS} = V_{GS}, I_D = 250\mu A$
$\Delta V_{GS(th)}/\Delta T_J$	Gate Threshold Voltage Coefficient	—	-5.4	—	mV/°C	
$I_{DSS}$	Drain-to-Source Leakage Current	—	—	1.0	μA	$V_{DS} = 24V, V_{GS} = 0V$
		—	—	150		$V_{DS} = 24V, V_{GS} = 0V, T_J = 125^\circ\text{C}$
$I_{GSS}$	Gate-to-Source Forward Leakage	—	—	100	nA	$V_{GS} = 20V$
	Gate-to-Source Reverse Leakage	—	—	-100		$V_{GS} = -20V$
gfs	Forward Transconductance	39	—	—	S	$V_{DS} = 15V, I_D = 12A$
$Q_g$	Total Gate Charge	—	11	17	nC	$V_{DS} = 15V$ $V_{GS} = 4.5V$ $I_D = 12A$ See Fig. 16
$Q_{gs1}$	Pre-Vth Gate-to-Source Charge	—	3.1	—		
$Q_{gs2}$	Post-Vth Gate-to-Source Charge	—	1.0	—		
$Q_{gd}$	Gate-to-Drain Charge	—	4.0	—		
$Q_{godr}$	Gate Charge Overdrive	—	2.9	—		
$Q_{sw}$	Switch Charge ( $Q_{gs2} + Q_{gd}$ )	—	5.0	—		
$Q_{oss}$	Output Charge	—	10	—	nC	$V_{DS} = 15V, V_{GS} = 0V$
$t_{d(on)}$	Turn-On Delay Time	—	11	—	ns	$V_{DD} = 16V, V_{GS} = 4.5V$ ③ $I_D = 12A$ Clamped Inductive Load
$t_r$	Rise Time	—	34	—		
$t_{d(off)}$	Turn-Off Delay Time	—	12	—		
$t_f$	Fall Time	—	3.7	—		
$C_{iss}$	Input Capacitance	—	1300	—	pF	$V_{GS} = 0V$
$C_{oss}$	Output Capacitance	—	430	—		$V_{DS} = 15V$
$C_{rss}$	Reverse Transfer Capacitance	—	160	—		$f = 1.0MHz$

## Diode Characteristics

	Parameter	Min.	Typ.	Max.	Units	Conditions
$I_S$	Continuous Source Current (Body Diode)	—	—	53	A	MOSFET symbol showing the integral reverse p-n junction diode.
$I_{SM}$	Pulsed Source Current (Body Diode) ①	—	—	120		
$V_{SD}$	Diode Forward Voltage	—	0.81	1.0	V	$T_J = 25^\circ\text{C}, I_S = 12A, V_{GS} = 0V$ ③
$t_{rr}$	Reverse Recovery Time	—	16	24	ns	$T_J = 25^\circ\text{C}, I_F = 12A$
$Q_{rr}$	Reverse Recovery Charge	—	7.2	11	nC	$di/dt = 100A/\mu s$ ③

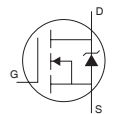

### Notes:

- ① Repetitive rating; pulse width limited by max. junction temperature.
- ② Starting  $T_J = 25^\circ\text{C}$ ,  $L = 0.40mH$ ,  $R_G = 25\Omega$ ,  $I_{AS} = 12A$ .
- ③ Pulse width  $\leq 400\mu s$ ; duty cycle  $\leq 2\%$ .
- ④ Surface mounted on 1 in. square Cu board.
- ⑤ Used double sided cooling, mounting pad.
- ⑥ Mounted on minimum footprint full size board with metalized back and with small clip heatsink.
- ⑦  $T_C$  measured with thermal couple mounted to top (Drain) of part.
- ⑧  $R_{\theta}$  is measured at  $T_J$  of approximately  $90^\circ\text{C}$ .

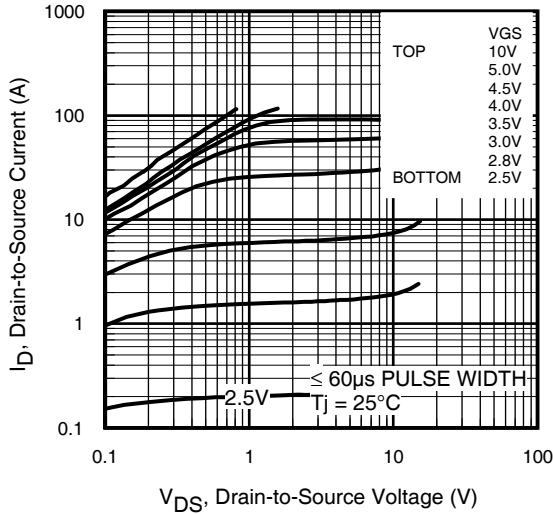

Fig 1. Typical Output Characteristics

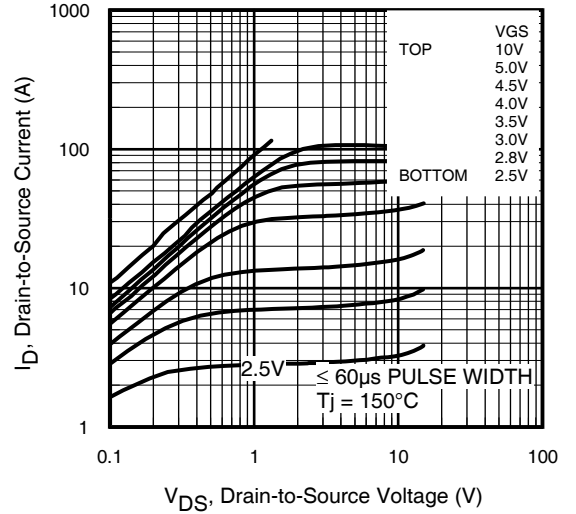

Fig 2. Typical Output Characteristics

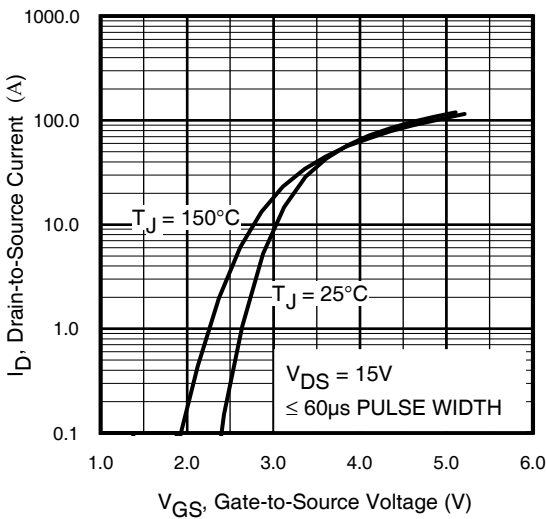

Fig 3. Typical Transfer Characteristics

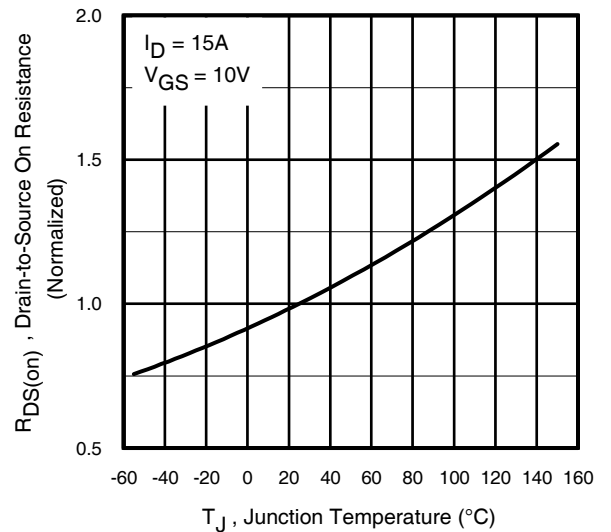

Fig 4. Normalized On-Resistance vs. Temperature

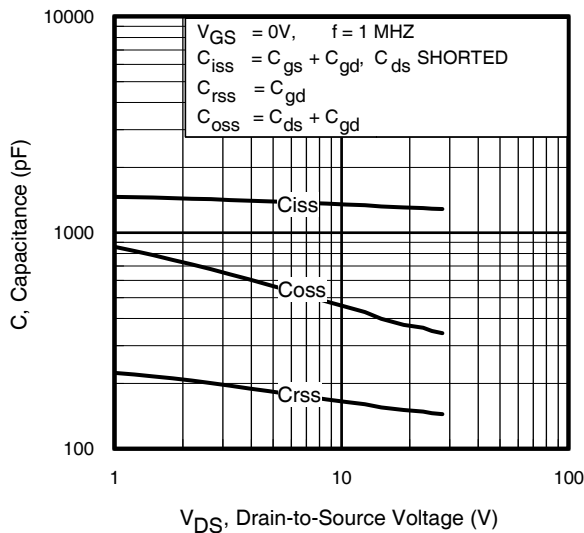

Fig 5. Typical Capacitance vs. Drain-to-Source Voltage  
www.irf.com

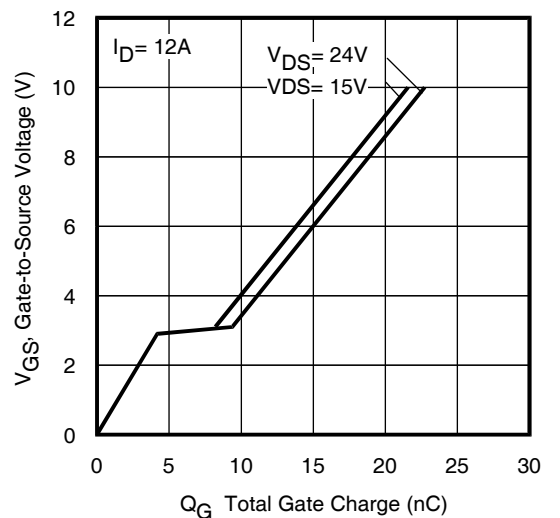
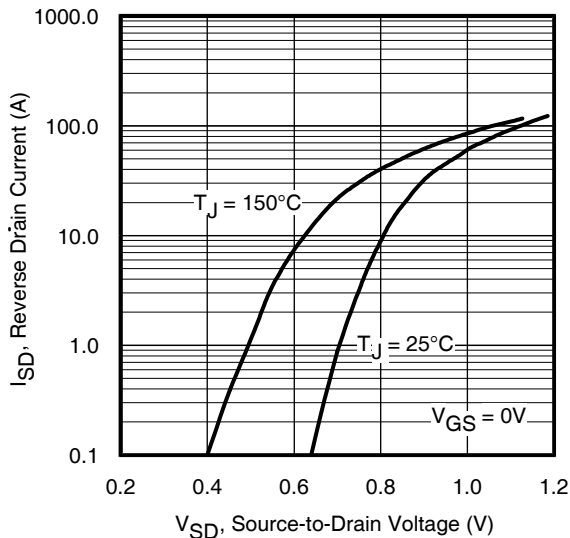
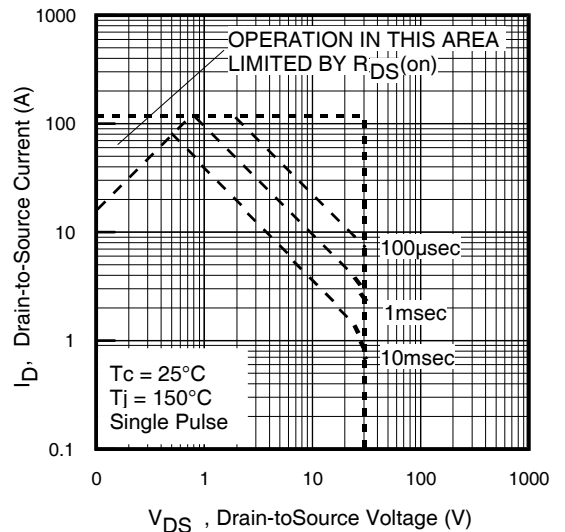

Fig 6. Typical Gate Charge vs. Gate-to-Source Voltage



**Fig 7.** Typical Source-Drain Diode Forward Voltage



**Fig 8.** Maximum Safe Operating Area

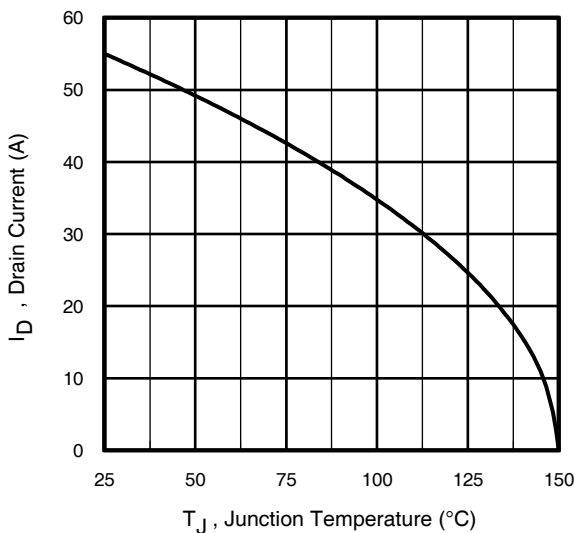

**Fig 9.** Maximum Drain Current vs. Case Temperature

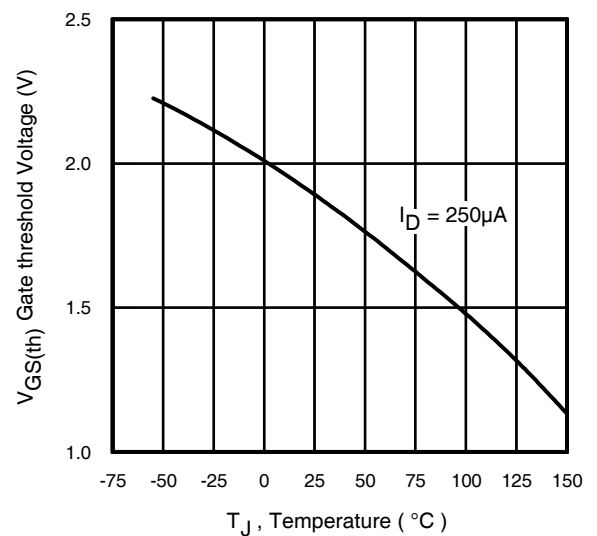

**Fig 10.** Threshold Voltage vs. Temperature

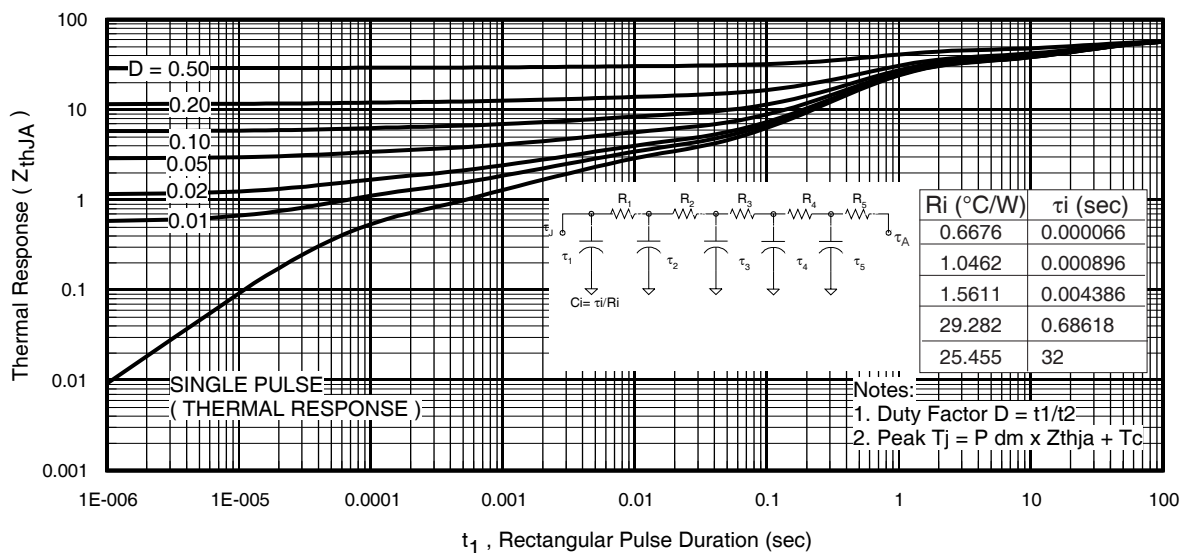

**Fig 11.** Maximum Effective Transient Thermal Impedance, Junction-to-Ambient

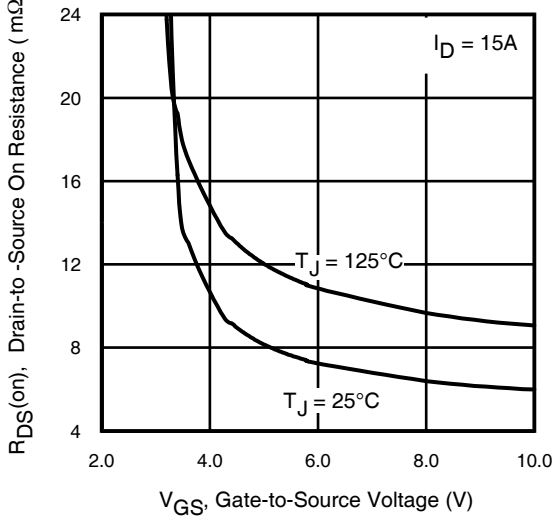

Fig 12. On-Resistance Vs. Gate Voltage

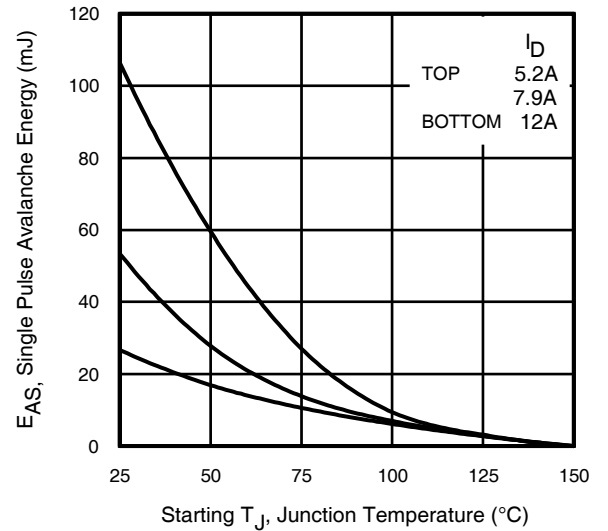

Fig 13. Maximum Avalanche Energy Vs. Drain Current

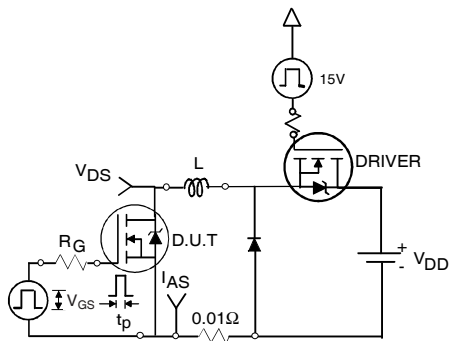

Fig 14a. Unclamped Inductive Test Circuit

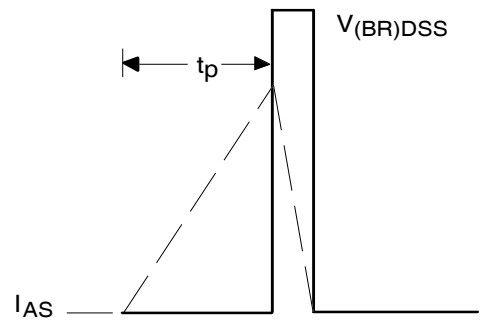

Fig 14b. Unclamped Inductive Waveforms

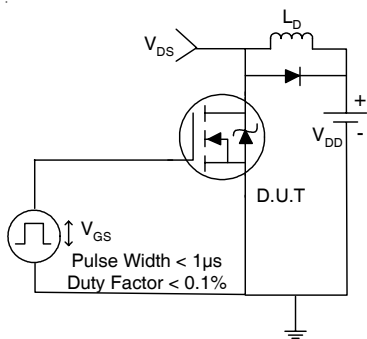

Fig 15a. Switching Time Test Circuit

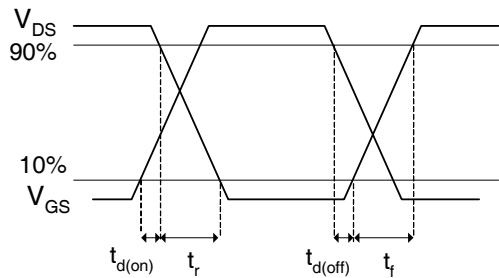

Fig 15b. Switching Time Waveforms

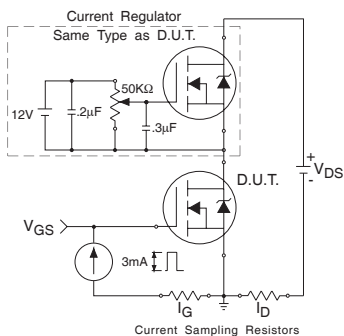

Fig 16a. Gate Charge Test Circuit

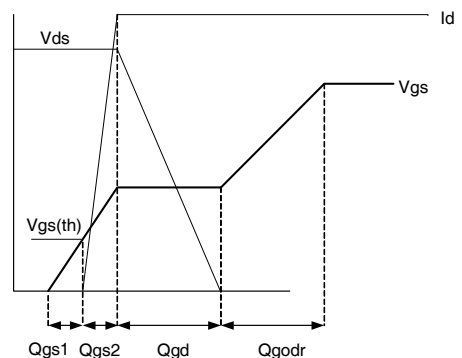
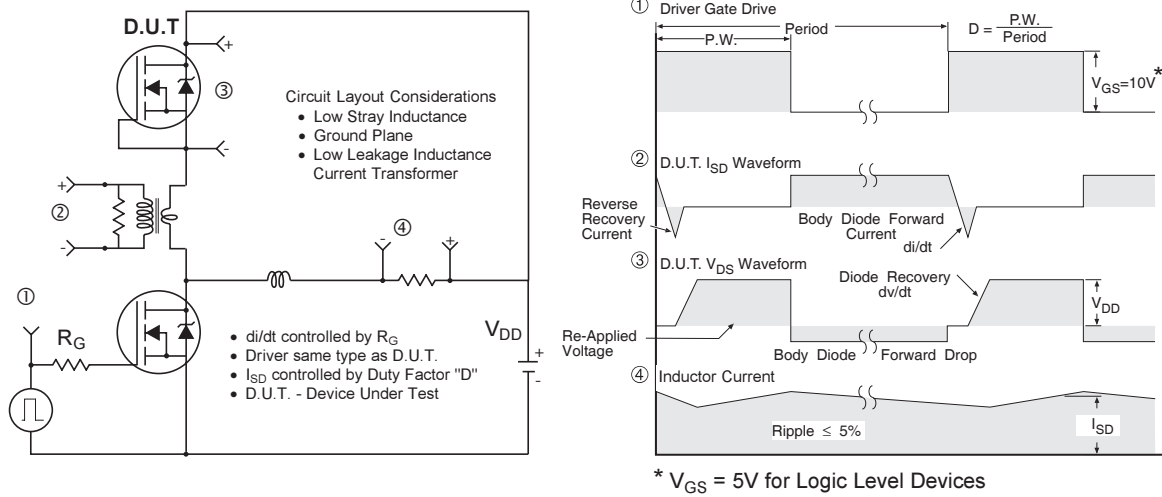

Fig 16b. Gate Charge Waveform

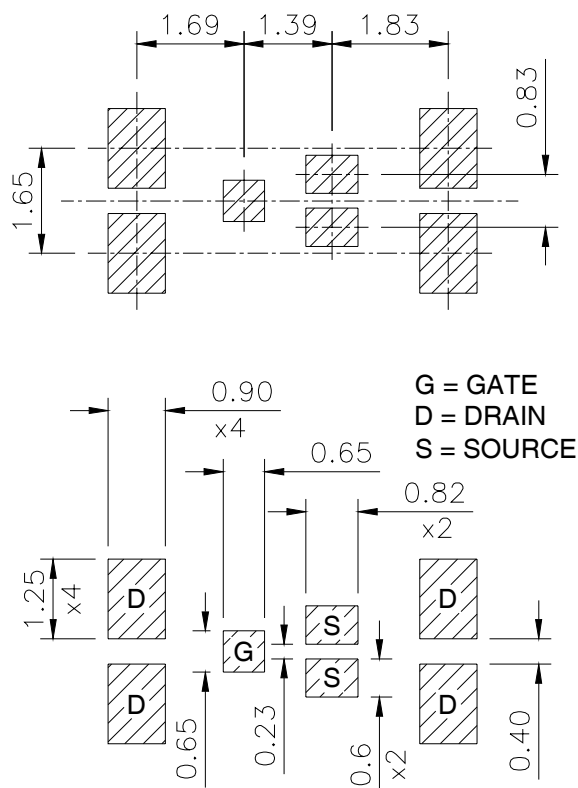

**Fig 17. Diode Reverse Recovery Test Circuit for N-Channel HEXFET® Power MOSFETs**

## DirectFET™ Substrate and PCB Layout, ST Outline (Small Size Can, T-Designation).

Please see DirectFET application note AN-1035 for all details regarding the assembly of DirectFET.

This includes all recommendations for stencil and substrate designs.



**DirectFET™ Outline Dimension, ST Outline  
 (Small Size Can, T-Designation).**

Please see DirectFET application note AN-1035 for all details regarding the assembly of DirectFET.

This includes all recommendations for stencil and substrate designs.

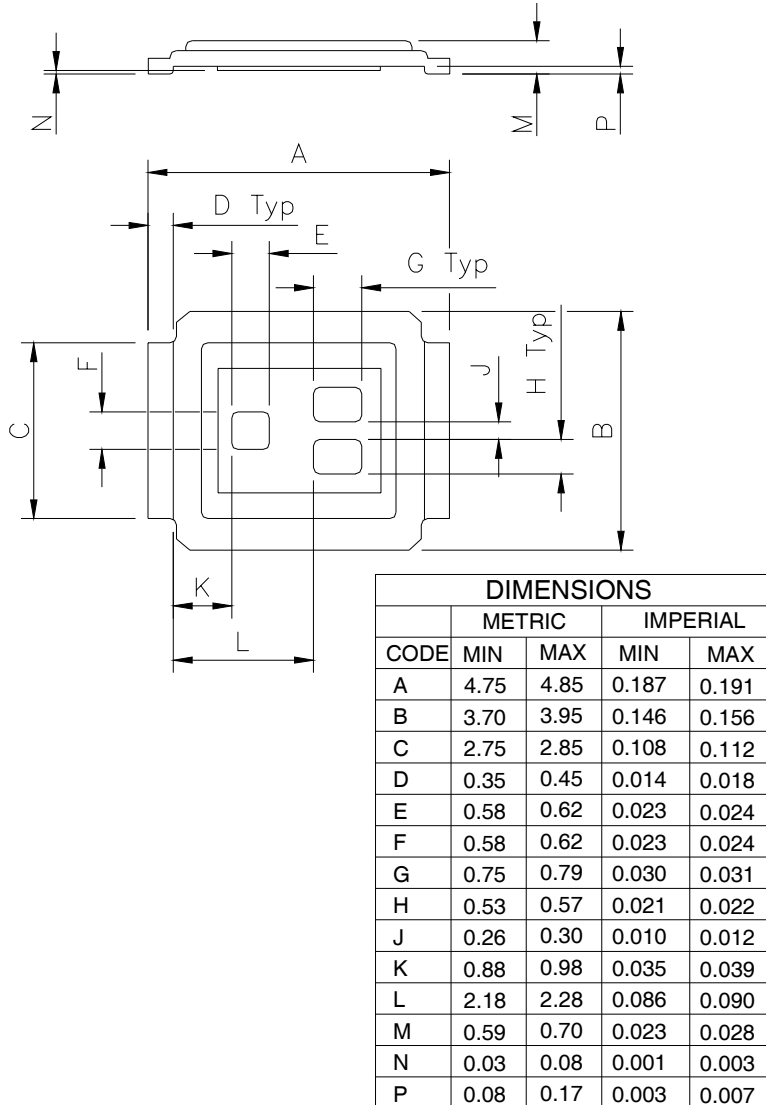

**DirectFET™ Part Marking**

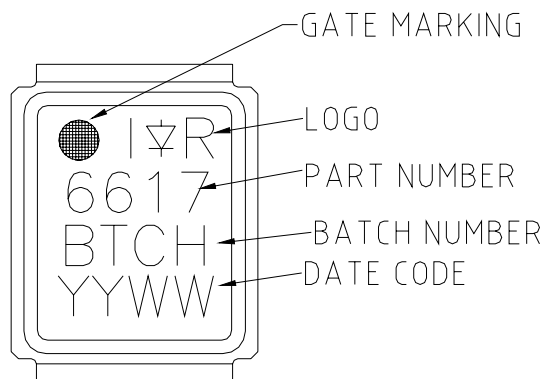

# IRF6617

DirectFET™ Tape & Reel Dimension (Showing component orientation).

International  
**IR** Rectifier

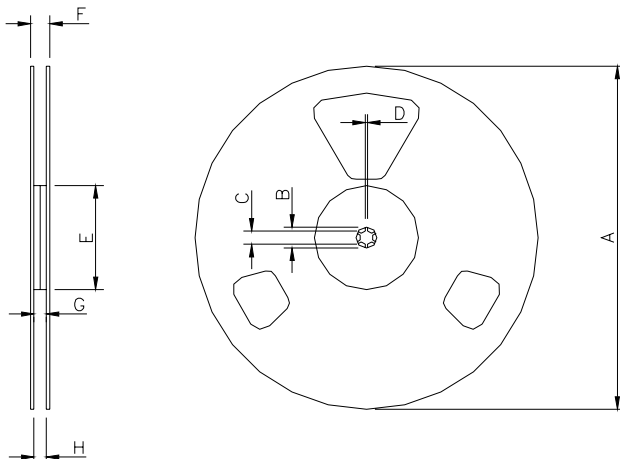

NOTE: Controlling dimensions in mm  
Std reel quantity is 4800 parts. (ordered as IRF6617). For 1000 parts on 7" reel, order IRF6617TR1

REEL DIMENSIONS								
CODE	STANDARD OPTION (QTY 4800)				TR1 OPTION (QTY 1000)			
	METRIC		IMPERIAL		METRIC		IMPERIAL	
	MIN	MAX	MIN	MAX	MIN	MAX	MIN	MAX
A	330.0	N.C	12.992	N.C	177.77	N.C	6.9	N.C
B	20.2	N.C	0.795	N.C	19.06	N.C	0.75	N.C
C	12.8	13.2	0.504	0.520	13.5	12.8	0.53	0.50
D	1.5	N.C	0.059	N.C	1.5	N.C	0.059	N.C
E	100.0	N.C	3.937	N.C	58.72	N.C	2.31	N.C
F	N.C	18.4	N.C	0.724	N.C	13.50	N.C	0.53
G	12.4	14.4	0.488	0.567	11.9	12.01	0.47	N.C
H	11.9	15.4	0.469	0.606	11.9	12.01	0.47	N.C

Loaded Tape Feed Direction

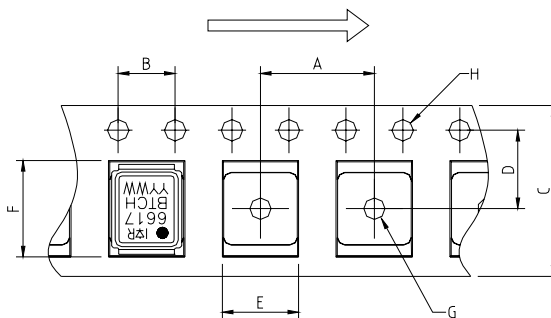

NOTE: CONTROLLING DIMENSIONS IN MM

CODE	DIMENSIONS			
	METRIC		IMPERIAL	
	MIN	MAX	MIN	MAX
A	7.90	8.10	0.311	0.319
B	3.90	4.10	0.154	0.161
C	11.90	12.30	0.469	0.484
D	5.45	5.55	0.215	0.219
E	4.00	4.20	0.157	0.165
F	5.00	5.20	0.197	0.205
G	1.50	N.C	0.059	N.C
H	1.50	1.60	0.059	0.063

Data and specifications subject to change without notice.  
This product has been designed and qualified for the Consumer market.  
Qualification Standards can be found on IR's Web site.

International  
**IR** Rectifier

IR WORLD HEADQUARTERS: 233 Kansas St., El Segundo, California 90245, USA Tel: (310) 252-7105  
TAC Fax: (310) 252-7903

Visit us at [www.irf.com](http://www.irf.com) for sales contact information.11/05

[www.irf.com](http://www.irf.com)



Note: For the most current drawings please refer to the IR website at:  
<http://www.irf.com/package/>