

3Com® EtherLink®

EtherLink PCI Network Interface Cards User Guide



MODEL NOS.
3C905C-TX-M
3C905B
3C900B





EtherLink® PCI Network Interface Cards User Guide

3C905C-TX-M For Complete PC Management
3C905B
3C900B

<http://www.3com.com/>
<http://www.3com.com/productreg>

Part No. 09-1743-000
Published June 1999

3Com Corporation ■ 5400 Bayfront Plaza ■ Santa Clara, California ■ 95052-8145

Copyright © 1999, 3Com Corporation. All rights reserved. No part of this documentation may be reproduced in any form or by any means or used to make any derivative work (such as translation, transformation, or adaptation) without written permission from 3Com Corporation.

3Com Corporation reserves the right to revise this documentation and to make changes in content from time to time without obligation on the part of 3Com Corporation to provide notification of such revision or change.

3Com Corporation provides this documentation without warranty, term, or condition of any kind, either implied or expressed, including, but not limited to, the implied warranties, terms or conditions of merchantability, satisfactory quality, and fitness for a particular purpose. 3Com may make improvements or changes in the product(s) and/or the program(s) described in this documentation at any time.

If there is any software on removable media described in this documentation, it is furnished under a license agreement included with the product as a separate document, in the hard copy documentation, or on the removable media in a directory file named LICENSE.TXT or !LICENSE.TXT. If you are unable to locate a copy, please contact 3Com and a copy will be provided to you.

UNITED STATES GOVERNMENT LEGEND

If you are a United States government agency, then this documentation and the software described herein are provided to you subject to the following:

All technical data and computer software are commercial in nature and developed solely at private expense. Software is delivered as "Commercial Computer Software" as defined in DFARS 252.227-7014 (June 1995) or as a "commercial item" as defined in FAR 2.101(a) and as such is provided with only such rights as are provided in 3Com's standard commercial license for the Software. Technical data is provided with limited rights only as provided in DFAR 252.227-7015 (Nov 1995) or FAR 52.227-14 (June 1987), whichever is applicable. You agree not to remove or deface any portion of any legend provided on any licensed program or documentation contained in, or delivered to you in conjunction with, this User Guide.

Unless otherwise indicated, 3Com registered trademarks are registered in the United States and may or may not be registered in other countries.

3Com, the 3Com logo, DynamicAccess, EtherDisk, EtherLink, and Parallel Tasking are registered trademarks of 3Com Corporation. 3Com Facts is a service mark of 3Com Corporation.

Microsoft, Windows, and Windows NT are trademarks of Microsoft Corp. Novell and NetWare are trademarks of Novell, Inc.

All other company and product names may be trademarks of the respective companies with which they are associated.

CONTENTS

ABOUT THIS GUIDE

Conventions	10
Year 2000 Compliance	10

1 INTRODUCTION

Overview	11
3C905C-TX-M	11
3C905B	13
3C905B-TX	13
3C905B-COMBO	14
3C905B-FX	14
3C900B	15
Remote Wake-Up	17
Remote Wake-Up Cable	17
Remote Wake-Up Requirements	17
3C905C-TX-M NIC	18
3C905B and 3C900B-FL NICs	18
Multiple NIC Installations and Remote Wake-Up	18
Managed PC Boot Agent (MBA) Software	18
Desktop Management Interface (DMI) 2.0	19
DynamicAccess LAN Agent	19
Remote System Alerts	20

2 INSTALLING AND CONNECTING THE NIC

Overview	21
Meeting PC Requirements	21
Installation Steps	21
Installing Multiple NICs	22
Upgrading Windows 95 to Windows 98	22
Updating the Network Driver and NIC Software	22
Installing a 3C900 or 3C905 NIC	22

Installing From Diskette	22
Running the Preinstallation Program	24
Inserting the NIC in the PC	25
Connecting the Remote Wake-Up Cable	28
Connecting the NIC to the Network	29
RJ-45 Port	29
BNC Port	31
AUI Port	32
SC Port	33
ST Port	34

3 INSTALLING NIC SOFTWARE IN WINDOWS

Overview	37
Installing the Network Driver Using the EtherCD	37
Windows 95	38
Windows 98	39
Windows NT 4.0	41
Windows NT 3.51	42
Verifying Successful Installation	43
Windows 95 and Windows 98	43
Windows NT 4.0	43
Windows NT 3.51	43
Installing the 3Com NIC Diagnostics Program	44
Updating the Network Driver and NIC Software	45
Installing Multiple NICs	45
Windows 95 and Windows 98	46
Windows NT 4.0	47

4 INSTALLING THE NETWARE CLIENT AND SERVER DRIVERS

Overview	49
Installing the NetWare Client Driver	49
About 3Com Intelligent Auto Install Software	49
Intelligent Auto Install Requirements	50
Running the Intelligent Auto Install Software	50
Installing the NetWare Server Driver	51
Obtaining NetWare Loadable Modules	51
NetWare 3.12	52

NetWare 4.x	52
Importing the Server Driver	52
Loading the Driver Manually	53
NetWare 5.x	53
Importing the Server Driver	53
Loading the Driver Manually	54
Installing Multiple NICs	55
Verifying the PCI Slot Number	56

5 CONFIGURING THE NIC

Overview	57
Default NIC Settings	57
Configuration Methods	58
Changing General NIC Configuration Settings	59
Configuring the Managed PC Boot Agent (MBA)	60
Enabling or Disabling the Boot ROM Setting	61
Booting From the Network	61
BBS BIOS-Compatible PCs	62
Non-BBS BIOS-Compatible PCs	63

6 TROUBLESHOOTING THE NIC

Overview	65
Accessing 3Com Support Databases	65
Accessing the 3Com Knowledgebase	65
Accessing the 3Com NIC Help System	66
Accessing Release Notes and Frequently Asked Questions	66
Troubleshooting the NIC Installation	67
Problems/Error Messages	67
Cleaning Up a Failed Installation	67
Troubleshooting the Network Connection	68
Troubleshooting Remote Wake-Up	69
Removing the Network Driver	70
Windows 95 and Windows 98	70
Windows NT 4.0	71
Windows NT 3.51	71
Removing the 3Com NIC Diagnostics Program	72

7 RUNNING NIC DIAGNOSTICS

- Overview 73
- Interpreting the LEDs 73
- Running the NIC Diagnostics Tests 75
 - To Run the Network Test 75
 - To Run the NIC Test 76
 - To Run the Remote Wake-Up Test 76
- Viewing Network Statistics 77
- Using the 3Com Icon in the Windows System Tray 78

A SPECIFICATIONS AND CABLING REQUIREMENTS

- 3C905C-TX-M NIC Specifications 79
- 3C905B NICs Specifications 80
- 3C900B NICs Specifications 81
- Cabling Requirements 82
 - Twisted-Pair Cable 82
 - 10BASE-T Operation 83
 - 100BASE-TX Operation 84
- RJ-45 Connector Pin Assignments 84

B INSTALLING THE DYNAMICAccess LAN AGENT

- Overview 85
- Client PC Requirements 85
- Installing the DynamicAccess LAN Agent 86
- Verifying Successful Installation 87
- Configuring the DynamicAccess LAN Agent 87
- Removing DynamicAccess Technology 88

C INSTALLING THE 3COM DMI AGENT

- Overview 89
- About the 3Com DMI Agent 89
- System Requirements 90
 - Client PC Requirements 90
 - Network Management Requirements 91
- Installing the 3Com DMI Agent 91

D TECHNICAL SUPPORT

Online Technical Services	93
World Wide Web Site	93
3Com Knowledgebase Web Services	94
3Com FTP Site	94
3Com Bulletin Board Service	94
Access by Analog Modem	94
Access by Digital Modem	95
3Com Facts Automated Fax Service	95
Support from Your Network Supplier	95
Support from 3Com	96
Returning Products for Repair	97

INDEX

3COM CORPORATION LIMITED WARRANTY

FCC CLASS B STATEMENT

FCC DECLARATION OF CONFORMITY

INDUSTRY CANADA CLASS B EMISSION COMPLIANCE STATEMENT

AVIS DE CONFORMITÉ À LA RÉGLEMENTATION D'INDUSTRIE CANADA

VCCI CLASS B STATEMENT

3COM END USER SOFTWARE LICENSE AGREEMENT

PRODUCT REGISTRATION

ABOUT THIS GUIDE

This guide describes how to install, configure, and troubleshoot the following 3Com® EtherLink® PCI network interface cards (NICs):

NIC	Model Number
EtherLink 10/100 PCI For Complete PC Management	3C905C-TX-M
EtherLink 10/100 PCI	3C905B-TX 3C905B-TX-M 3C905B-TX-NM 3C905B-COMBO
EtherLink 100 PCI Fiber	3C905B-FX
EtherLink 10 PCI Fiber	3C900B-FL
EtherLink 10 PCI	3C900B-TPO 3C900B-COMBO

This guide is intended for those who install and configure Ethernet NICs. Some familiarity with Ethernet networks and NICs is assumed.



If release notes are shipped with your product and the information there differs from the information in this guide, follow the instructions in the release notes.

Most user guides and release notes are available in Adobe Acrobat Reader Portable Document Format (PDF) or HTML on the 3Com World Wide Web site:



<http://www.3com.com/>

You can download Acrobat Reader from the *EtherCD* or from Adobe Systems Incorporated Web site:

<http://www.adobe.com/>

Conventions

The following tables list conventions that are used throughout this guide.

Icon	Notice Type	Description
	Information note	Information that describes important features or instructions
	Caution	Information that alerts you to potential loss of data or potential damage to an application, system, or device
	Warning	Information that alerts you to potential personal injury

Convention	Description
Screen displays	This typeface represents information as it appears on the screen.
Commands	<p>The word "command" means that you must enter the command exactly as shown and then press Return or Enter. Commands appear in bold. Example:</p> <p>To launch the DOS diagnostics program, enter the following command:</p> <p>a: install</p>
The words "enter" and "type"	When you see the word "enter" in this guide, you must type something, and then press Return or Enter. Do not press Return or Enter when an instruction simply says "type."
Words in <i>italics</i>	<p>Italics are used to:</p> <ul style="list-style-type: none"> ■ Emphasize a point. ■ Denote a new term at the place where it is defined in the text. ■ Identify menu names, menu commands, and software button names. Examples: <p>From the <i>Help</i> menu, select <i>Contents</i>.</p> <p>Click <i>OK</i>.</p>

Year 2000 Compliance

For information on Year 2000 compliance and 3Com products, visit the 3Com Year 2000 Web page:

<http://www.3com.com/products/yr2000.html>

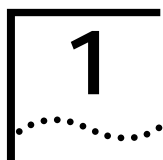

INTRODUCTION

Overview

This chapter describes the following 3Com® EtherLink® PCI network interface cards (NICs):

NIC	Model Number
EtherLink 10/100 PCI For Complete PC Management	3C905C-TX-M
EtherLink 10/100 PCI	3C905B 3C905B-TX-M 3C905B-TX-NM 3C905B-COMBO
EtherLink 100 PCI Fiber	3C905B-FX
EtherLink 10 PCI Fiber	3C900B-FL
EtherLink 10 PCI	3C900B-TPO 3C900B-COMBO



Unless specifically indicated, information in this user guide refers to all NIC models.

3C905C-TX-M

The 3C905C-TX-M NIC connects your PCI-compliant PC to either a 10 Mbps Ethernet network or a 100 Mbps Fast Ethernet network.

The 3C905C-TX-M NIC supports a suite of DynamicAccess® Technology features for desktop and network management, including:

- [Remote Wake-Up](#)
- [Managed PC Boot Agent \(MBA\) Software](#)
- [DynamicAccess LAN Agent](#) for traffic prioritization and remote monitoring (RMON and RMON2)

- [Desktop Management Interface \(DMI\) 2.0](#)
- [Remote System Alerts](#) (heartbeat packets)

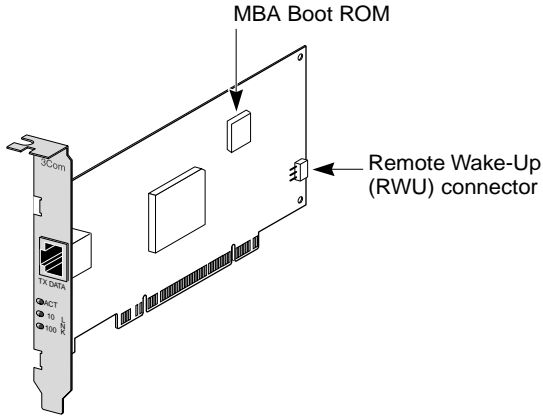

The following table describes the features of the 3C905C-TX-M NIC.

Features Supported	3C905C-TX-M NIC
■ RJ-45 connector for 10BASE-T or 100BASE-TX	✓
■ Remote Wake-Up	✓
■ DMI 2.0	✓
■ Integrated boot ROM with Managed PC Boot Agent (MBA) software	✓
■ Traffic prioritization	✓
■ Remote monitoring (RMON and RMON2)	✓
■ Efficient multicast control	✓
■ Remote system alerts (heartbeat packets)	✓

3C905B

The 3C905B NICs connect your PCI-compliant PC to either a 10 Mbps Ethernet network or a 100 Mbps Fast Ethernet network.

The 3C905B NICs support a suite of DynamicAccess Technology features for desktop and network management, including:

- [Remote Wake-Up](#)
- [Managed PC Boot Agent \(MBA\) Software](#) (3C905B-TX-M only)
- [DynamicAccess LAN Agent](#) for traffic prioritization and remote monitoring (RMON and RMON2)
- [Desktop Management Interface \(DMI\) 2.0](#)

3C905B-TX

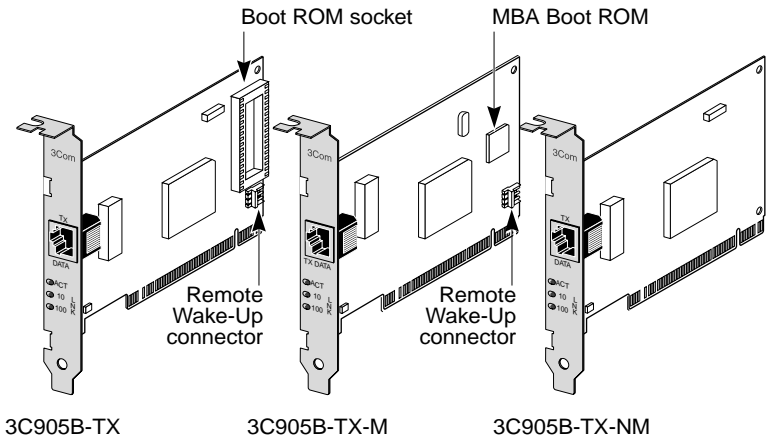

3C905B-COMBO

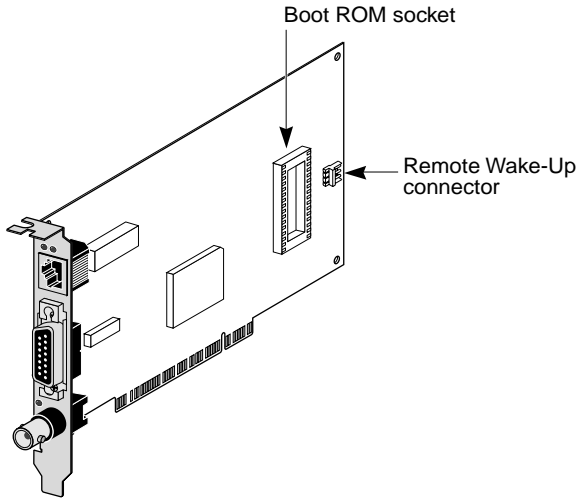

3C905B-FX

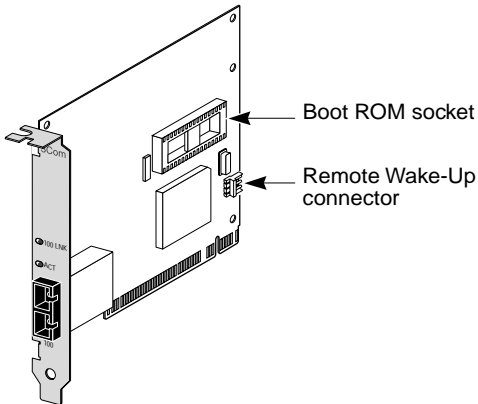

The following table describes the features of the 3C905B NICs.

Features Supported	3C905B NIC Model				
	-TX	-TX-M	-TX-NM	-COMBO	-FX
■ RJ-45 connector for 10BASE-T or 100BASE-TX	✓	✓	✓	✓	
■ AUI and BNC connectors for 10BASE5 and 10BASE2				✓	
■ SC connector for 100BASE-FX					✓
■ Remote Wake-Up	✓	✓		✓	✓
■ DMI 2.0	✓	✓	✓	✓	✓
■ Boot ROM socket	✓			✓	✓
■ Integrated boot ROM with Managed PC Boot Agent (MBA) software*		✓			
■ Traffic prioritization	✓	✓	✓	✓	✓
■ Remote monitoring (RMON and RMON2)	✓	✓	✓	✓	✓
■ Efficient multicast control	✓	✓	✓	✓	✓

* A boot ROM with MBA software can be purchased separately for use with the 3C905B-TX, 3C905B-COMBO, and 3C905B-FX NICs.

3C900B

The 3C900B NICs connect your PCI-compliant PC to a 10 Mbps Ethernet network.

The 3C900B NICs support the following DynamicAccess Technology features for desktop and network management:

- [Remote Wake-Up](#) (3C900B-FL only)
- [DynamicAccess LAN Agent](#) for traffic prioritization and remote monitoring (RMON and RMON2)
- [Desktop Management Interface \(DMI\) 2.0](#)

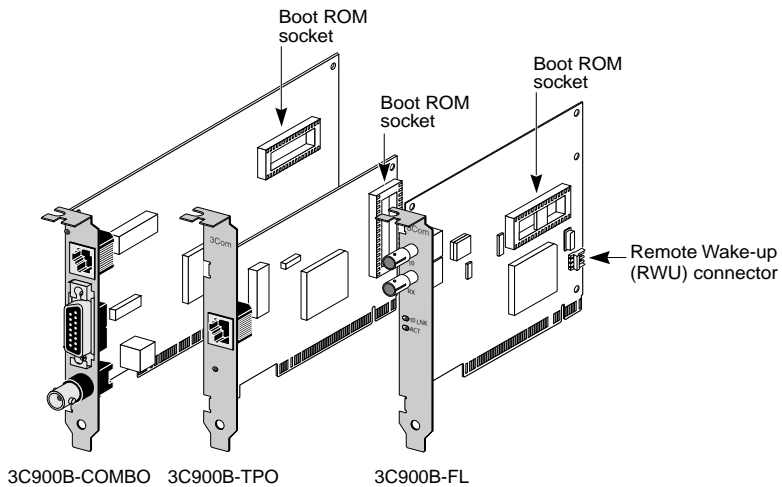

The following table describes the features of the 3C900B NICs.

Features Supported	3C900B NIC Model		
	-COMBO	-TPO	-FL
■ RJ-45 connector for 10BASE-T (10 Mbps only)	✓	✓	
■ BNC connector for 10BASE2 (10 Mbps only)	✓		
■ AU1 connector for 10BASE5 (10 Mbps only)	✓		
■ ST connector for 10BASE-FL			✓
■ Remote Wake-Up			✓
■ DMI 2.0	✓	✓	✓
■ Boot ROM socket*	✓	✓	✓
■ Traffic prioritization	✓	✓	✓
■ Remote monitoring (RMON and RMON2)	✓	✓	✓
■ Efficient multicast control	✓	✓	✓

* A boot ROM with Managed PC Boot Agent (MBA) software can be purchased separately for installation and use with the 3C900B NICs. See "[Managed PC Boot Agent \(MBA\) Software](#)" later in this chapter for more information.

Remote Wake-Up

Remote Wake-Up is the ability to remotely power-on a PC for after-hours administration.

Remote Wake-Up support is enabled by connecting a Remote Wake-Up cable from the NIC's Remote Wake-Up (RWU) connector to a 3-pin Remote Wake-Up connector on the PC motherboard. See "[Connecting the Remote Wake-Up Cable](#)" in [Chapter 2](#) for instructions.



For 3C905C-TX-M NICs, if your PC is compliant with PCI 2.2, Remote Wake-Up is automatically enabled through the PCI bus. The Remote Wake-Up cable is not required. (See your PC documentation if you are unsure whether your PC is compliant with PCI 2.2.)

Remote Wake-Up Cable

A Remote Wake-Up cable is shipped with each NIC that supports this feature.

To order additional Remote Wake-Up cables, contact 3Com:

- Toll-free number for the United States and Canada:
1-877-226-4604
- Toll number for international calls:
1-510-226-4604

Remote Wake-Up Requirements

The following NICs support Remote Wake-Up:

- 3C905C-TX-M
- 3C905B-TX
- 3C905B-TX-M
- 3C905B-COMBO
- 3C905B-FX
- 3C900B-FL

Your PC or server must have a management application that supports Remote Wake-Up. In addition, the following items are required to use Remote Wake-Up.

3C905C-TX-M NIC

- BIOS that supports Remote Wake-Up
- PCI 2.2-compliant bus or a 3-pin Remote Wake-Up connector on the PC motherboard and a 5-volt standby power supply unit rated at a minimum of 375 milliamperes

3C905B and 3C900B-FL NICs

- BIOS that supports Remote Wake-Up
- 3-pin Remote Wake-Up connector on the PC motherboard
- 5-volt standby power supply unit rated at a minimum of 375 milliamperes

If you are unsure whether your PC meets the requirements listed above, refer to your PC documentation or contact your PC manufacturer.

For more information on Remote Wake-Up, including a list of PCs that currently support this feature, go to:

<http://www.3com.com/partners/acpi>

Multiple NIC Installations and Remote Wake-Up

To use multiple NICs as Remote Wake-Up NICs in the same PC, the PC must have a power supply that can support multiple Remote Wake-Up devices.

See your PC documentation if you are unsure whether your PC power supply can accommodate more than one Remote Wake-Up device.

Managed PC Boot Agent (MBA) Software

The Managed PC Boot Agent (MBA) software adds management capabilities to the NIC by enabling the PC to boot from the server, rather than from its local drive.

This preboot support allows you to use management applications to remotely:

- Install and configure a new PC that has never been connected to the network.
- Upgrade software.

- Configure or reconfigure multiple systems simultaneously.
- Scan for viruses.
- Back-up hard drives and perform disaster recovery tasks.

For information on configuring the MBA to boot from the network, see "[Configuring the Managed PC Boot Agent \(MBA\)](#)" in [Chapter 5](#).

For detailed information on the MBA, see the *Managed PC Boot Agent User Guide*, located with the MBA software on the *EtherCD*.

Desktop Management Interface (DMI) 2.0

DMI 2.0 enables managed PCs and net PCs to report details about themselves and their peripheral devices across the network to a DMI 2.0-compliant management application.

A network administrator can then use this information to configure and manage a client or server PC remotely.

For instructions on installing the 3Com DMI Agent, see [Appendix C, "Installing the 3Com DMI Agent."](#)

For more detailed information on DMI, see the *3Com DMI Agent User Guide* located with the 3Com DMI Agent software on the *EtherCD*. Information is also available at:

<http://www.3com.com/managedpc>

DynamicAccess LAN Agent

The DynamicAccess LAN agent is advanced network software that improves performance, management, and control of your network.

The DynamicAccess LAN agent enables the following features:

- RMON SmartAgents — Enables full RMON reporting on all network segments, including switched networks, without the need to place dedicated RMON probes throughout the network. RMON SmartAgents are for use with the DynamicAccess network edge monitor or other remote monitoring applications.

- Traffic prioritization (IEEE 802.1p/Q) — Ensures that business-critical and delay-sensitive traffic (such as multimedia applications) has priority over normal data.
- Fast IP — Eliminates router bottlenecks and improves performance in switched networks.
- Efficient multicast control — Prevents flooding of switched networks by multicast applications such as video training, stock quotes, or online news.

The DynamicAccess LAN agent can be installed on a PC running Windows 95, Windows 98, or Windows NT. See [Appendix B, "Installing the DynamicAccess LAN Agent,"](#) for more information.

For detailed information on the DynamicAccess LAN agent, see the *DynamicAccess Technology User Guide* located on the *EtherCD*. Information is also available at:

<http://www.3com.com/dynamicaccess>

Remote System Alerts

The 3C905C-TX-M NIC can be configured to continuously transmit a packet to an alert target management station. If the management station fails to receive the regularly scheduled packet, an alert can be triggered that signals a possible PC power loss or theft.

The 3C905C-TX-M NIC can also transmit a workgroup keep-alive packet periodically while the PC is in a sleep state. This packet prevents the PC's workstation address from being aged-out of switch and router tables.



Only system administrators should configure these features. See the ADVCONFIG.TXT file located in the HELP directory on the EtherCD for more information.

2

INSTALLING AND CONNECTING THE NIC

Overview

This chapter describes how to install the NIC in your PC and connect it to an Ethernet or Fast Ethernet network.



WARNING: Before handling the NIC, touch the bare metal case of your PC to discharge static electricity from your body. While you are handling the NIC, wear a wrist strap grounded to the PC chassis.

Meeting PC Requirements

Your PC or server must meet the following requirements to successfully install the NIC:

- 80486, Pentium, or Alpha processor
- Available bus-mastering PCI slot
- Minimum of 640 K of memory

Installation Steps

There are four steps to the 3C90xB or 3C90xC NIC installation:

1 Run the preinstallation program *before* installing the NIC in the PC.

The *EtherCD* preinstallation program prevents conflicts with the NIC and your operating system. It guides you through the NIC installation and must be run *before* you physically install the NIC in the PC.

2 Install the NIC in the PC.

3 Connect the NIC to the network.

4 Install the network driver.

Installing Multiple NICs

If you are installing multiple EtherLink PCI NICs in a PC or server, follow the instructions in "[Installing Multiple NICs](#)" in [Chapter 3](#).

Upgrading Windows 95 to Windows 98

If you are upgrading a PC from Windows 95 to Windows 98 that already has an EtherLink PCI NIC installed, follow the instructions in the WIN98.TXT file located in the HELP directory on the *EtherCD*.

Updating the Network Driver and NIC Software

If you already have an EtherLink PCI NIC installed and want to update the network driver, follow the instructions in "[Updating the Network Driver and NIC Software](#)" later in this chapter.

Installing a 3C900 or 3C905 NIC

If you are installing a 3C900 or 3C905 NIC in a PC running Windows 98, follow the instructions in the WIN98.TXT file located in the Help directory on the *EtherCD*. Do not follow the instructions in this chapter.

Installing From Diskette

If your PC does not have a CD-ROM drive, access a PC that has a CD-ROM drive and create installation diskettes from the *EtherCD*.

If you do not have access to a PC that has a CD-ROM drive, contact 3Com to order installation diskettes for *EtherCD* version 5.1:

- Toll-free number for the United States and Canada:
1-877-226-4604
- Toll number for international calls:
1-510-226-4604



The installation diskettes allow you to install the network driver only. If you want to install the NIC diagnostics or desktop management software, you must install them from the EtherCD.

Before you start, make sure that you have two blank, formatted diskettes. Label the diskettes *EtherDisk 1* and *EtherDisk 2*.

- *EtherDisk 1* contains:
 - NDIS 3/4/5 drivers
 - NetWare client and server drivers
 - Windows for Workgroup drivers
 - NIC preinstallation program
 - README.TXT file
- *EtherDisk 2* contains:
 - NDIS 2 driver
 - PACKET driver
 - Help text files
 - DOS utilities

To create installation diskettes from the *EtherCD*:

- 1 Turn on the power to the PC and start Windows.**
- 2 Insert the *EtherCD* in the CD-ROM drive.**

The *EtherCD* Welcome screen appears.

If the *EtherCD* Welcome screen does not appear, enter the following command from the Run option of the Windows Start menu:

d:\installs\setup.exe

where d:\ represents the letter name of the CD-ROM drive.

- 3 Click *NIC Software*.**
- 4 Click *NIC Drivers and Diagnostics*.**
- 5 Click *Installation Utilities*.**
- 6 Click *Create Installation Diskettes*.**

The *EtherCD* Diskette Creation Utility Welcome screen appears.

- 7 Click *Next*.**
- 8 Insert the blank, formatted diskette labeled *EtherDisk 1* in the PC, and then click *Next*.**

Files are copied.

- 9 **Remove the disk and insert the disk labeled *EtherDisk 2* when prompted, and then click *OK*.**

Files are copied. The diskette creation is complete.



For instructions on using the installation diskettes to install the network driver, see the text file for your operating system in the HELP directory on the EtherCD.

Running the Preinstallation Program

Before you physically install the NIC in a PC, run the NIC preinstallation program to properly set up your system environment.

The preinstallation program prevents conflicts with the NIC and your operating system. It guides you through the NIC installation and must be run *before* you physically install the NIC in the PC.

To run the NIC preinstallation program:

- 1 **Do not install the NIC in the PC.**
- 2 **Turn on the power to the PC and start Windows.**
- 3 **Quit any open applications and disable the automatic protection feature of any anti-virus software that may be running.**
- 4 **Insert the *EtherCD* in the CD-ROM drive.**

The *EtherCD* Welcome screen appears.

If the *EtherCD* Welcome screen does not appear, enter the following command from the Run option of the Windows Start menu:

d:\installs\setup.exe

where d:\ represents the letter name of the CD-ROM drive.

- 5 **Click *NIC Software*.**
- 6 **Click *NIC Drivers and Diagnostics*.**

7 Click *Install NIC Driver*.

- To install the network driver and the 3Com NIC Diagnostics program, click *Install with Diagnostic Program*.
- To install the network driver only, click *Install without Diagnostic Program*.

Files are copied. A message box appears when the installation is complete.



On a Windows NT 4.0 PC, a message appears stating "Do you have to install NIC drivers for any EtherLink PCI NICs?" Click Yes. If the Microsoft TCP/IP Properties screen appears, complete the information as appropriate for your network, and then click OK.

8 Click *OK*.**9 Select your operating system to continue the installation.**

The Completing NIC Installation screen appears.

10 Click *Done*.**11 Exit the *EtherCD*, and then shut down Windows.****12 Turn off the power to the PC.**

Do not remove the *EtherCD* from the CD-ROM drive.

The next step is to install the NIC in the PC. Go to the next section, "[Inserting the NIC in the PC.](#)"

Inserting the NIC in the PC

The following instructions apply to installing the NIC in most PCs. If these instructions are not appropriate for your PC, refer to the documentation that accompanied your PC.



Do NOT install the NIC in your PC until you have run the preinstallation program, as described in the previous section, "[Running the Preinstallation Program](#)."

Before handling the NIC, touch the bare metal case of your PC to discharge static electricity from your body. While you are handling the NIC, wear a wrist strap grounded to the PC chassis.

To install the NIC in the PC:

- 1 Make sure that you have run the preinstallation program, as described in the previous section.**
- 2 Remove all jewelry from your hands and wrists. Use only insulated or nonconducting tools.**
- 3 Turn off the power to the PC and unplug the power cord.**
- 4 Remove the cover from the PC.**
- 5 Locate an empty, nonshared bus-mastering PCI slot and remove its slot cover. Save the screw.**



Do not install the NIC in a shared PCI slot. Avoid any PCI slot next to an ISA slot. This is often a shared slot and does not support bus mastering.

If you do not know how to identify a PCI slot, check your PC documentation or ask your system administrator.



If you are planning to install the Remote Wake-Up cable, choose an empty PCI slot that is close to the matching connector on the PC motherboard. The Remote Wake-Up cable is only required if your NIC supports Remote Wake-Up and you want to use this feature.

- 6 Carefully insert the NIC in the empty PCI slot.**
Press firmly to ensure that the NIC is fully seated in the slot.

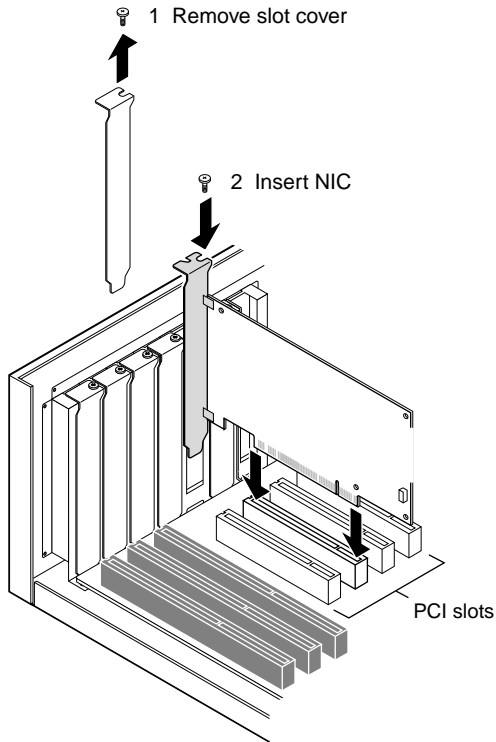

7 Secure the NIC with the screw you removed earlier.



If you want to install the Remote Wake-Up cable, go to the next section, "[Connecting the Remote Wake-Up Cable](#)" to continue the installation. If you do not want to connect the cable, continue with [step 8](#).

8 Replace the PC cover and plug in the power cord.

Do not turn on the power to the PC.

The next step is to connect the NIC to the network. Go to "[Connecting the NIC to the Network](#)."

Connecting the Remote Wake-Up Cable

This section describes how to connect the Remote Wake-Up cable from the NIC to the PC motherboard.

Connecting the Remote Wake-Up cable is optional. Connect this cable only if your NIC supports Remote Wake-Up and you want to use this feature.

The following NICs support Remote Wake-Up:

- 3C905C-TX-M
- 3C905B-TX
- 3C905B-TX-M
- 3C905B-COMBO
- 3C905B-FX
- 3C900B-FL



If you have a 3C905C-TX-M NIC and your PC is compliant with PCI 2.2, Remote Wake-Up is automatically enabled through the PCI bus. You do not need to connect the Remote Wake-Up cable.

To connect the Remote Wake-Up cable:



WARNING: *Make sure that the PC power cord is unplugged. Only properly trained and authorized personnel should perform service. Contact your PC manufacturer for information about safe service techniques.*

- 1 Make sure that the NIC is properly installed in a PCI slot.**
- 2 Insert the Remote Wake-Up cable into the RWU connector on the NIC.**
- 3 Attach the other end of the cable to the connector on the PC motherboard.**

Refer to your PC documentation if you need help locating the connector.

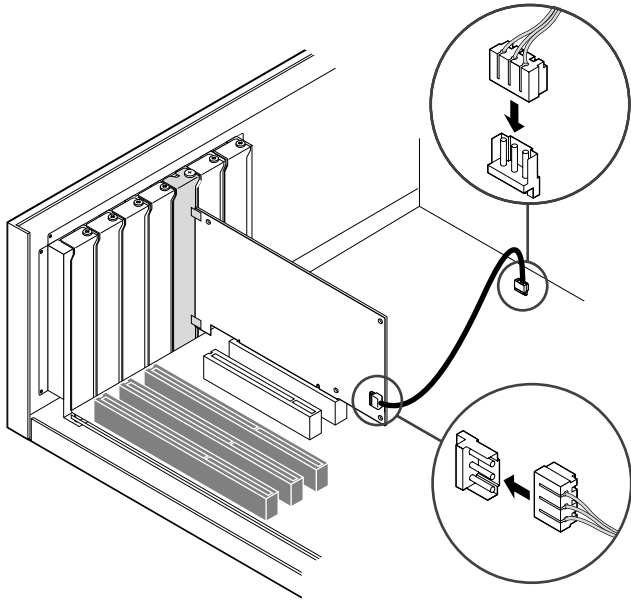

4 Replace the PC cover and plug in the power cord.

Do not turn on the power to the PC. The next step is to connect the NIC to the network. Go to the next section, "[Connecting the NIC to the Network.](#)"

Connecting the NIC to the Network

Follow the procedure for the port that matches your NIC and your network environment.

RJ-45 Port

On the 3C900B NIC, the RJ-45 port provides a 10 Mbps connection only.

On the 3C905C-TX-M and 3C905B NICs, the RJ-45 port provides a 10 Mbps or 100 Mbps connection automatically, depending on the speed of the connected hub or switch.

The following table shows the cable requirements and maximum network cable lengths for the RJ-45 port.

Network Environment	Cable Required	Maximum Cable Length
10 Mbps (10BASE-T)	Category 3, 4, or 5 unshielded twisted-pair	100 m (328 ft)
100 Mbps (100BASE-TX)	Category 5 unshielded twisted-pair	100 m (328 ft)

To connect the RJ-45 port:

- 1 Plug the RJ-45 connector on the twisted-pair network cable into the RJ-45 port on the NIC backplate.**

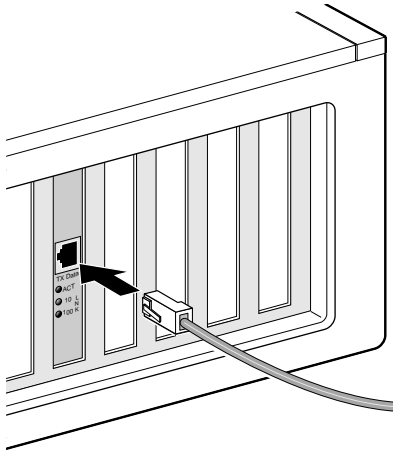

- 2 Connect the other end of the network cable to an active network port.**

The next step is to install the network driver.

Go to [Chapter 3, "Installing NIC Software in Windows,"](#) or [Chapter 4, "Installing the NetWare Client and Server Drivers."](#)

BNC Port

The BNC port provides a 10 Mbps connection only.

The following table shows the cable requirement and maximum network cable length for the BNC port.

Port	Cable Required	Maximum Network Cable Length
BNC	10BASE2 thin Ethernet coaxial (10 Mbps only)	185 m (607 ft)

To connect the BNC port:

- 1 Connect the BNC connector on the thin Ethernet cable to the BNC port on the NIC.**

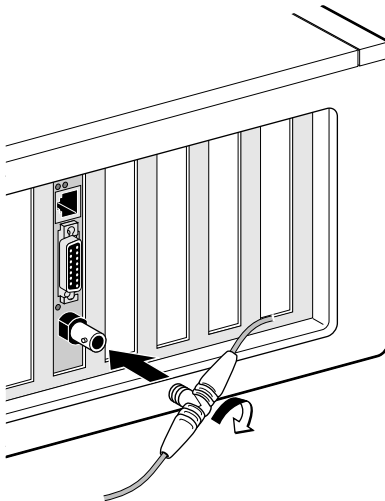

- 2 Connect the other end of the network cable to another PC or to a 50-ohm terminator.**



If your PC is the last physical device in the network daisy chain, you must connect a 50-ohm terminator to the other end of the BNC T-connector.

The next step is to install the network driver.

Go to [Chapter 3, "Installing NIC Software in Windows,"](#) or [Chapter 4, "Installing the NetWare Client and Server Drivers."](#)

AUI Port

The AUI port provides a 10 Mbps connection only.

The following table shows the cable requirement and maximum network cable length for the AUI port.

Port	Cable Required	Maximum Network Cable Length
15-pin AUI	10BASE5 thick Ethernet coaxial (10 Mbps only)	500 m (1,640 ft)

To connect the AUI port:

- 1 Locate the 15-pin AUI port on the NIC and move the slide latch down to the open position.**
- 2 Connect the thick Ethernet coaxial cable to the AUI port on the NIC.**

This connector attaches in only one way. Orient the AUI connector to match the AUI port on the NIC.

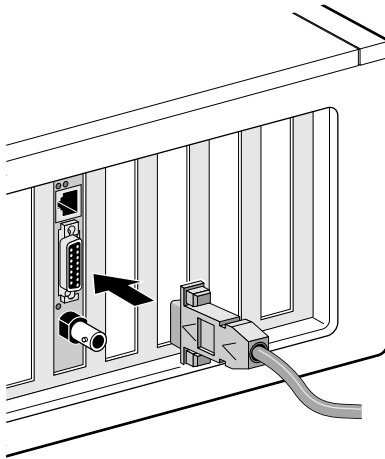

- 3 Move the slide latch up to the closed position to lock the AUI connector in place.**
- 4 Connect the other end of the network cable to an external transceiver.**

The next step is to install the network driver.

Go to [Chapter 3, "Installing NIC Software in Windows,"](#) or [Chapter 4, "Installing the NetWare Client and Server Drivers."](#)

SC Port

The SC port on the 3C905B-FX NIC provides a 100 Mbps fiber-based connection only.

The following table shows the cable requirements and maximum network cable lengths for the SC port.

Port	Cable Required	Maximum Network Cable Length
SC	Long-wavelength fiber-optic (1300 nm):	
	<ul style="list-style-type: none"> ■ 50 μ/125 μ multimode fiber ■ 62.5 μ/125 μ multimode fiber 	Full-duplex: 2,000 m (6,560 ft) Half-duplex: 412 m (1,351 ft)

To connect the SC port:

- 1 Remove the protective cover from the NIC's SC connector.**
- 2 Connect the network cable to the SC connector on the NIC.**

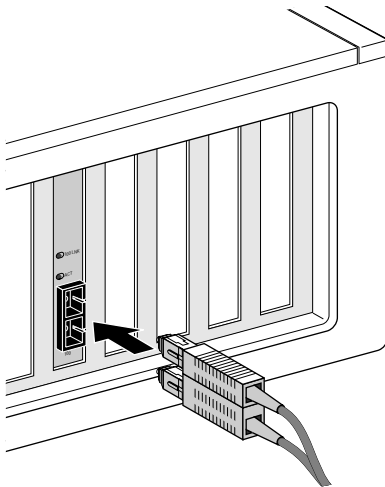

- 3 Connect the other end of the cable to an active 100BASE-FX Fast Ethernet network port.**

The next step is to install the network driver.

Go to [Chapter 3, "Installing NIC Software in Windows,"](#) or [Chapter 4, "Installing the NetWare Client and Server Drivers."](#)

ST Port

The ST port on the 3C900B-FL NIC provides a 10 Mbps fiber-based connection only.

The following table shows the cable requirements and maximum network cable lengths for the ST port.

Port	Cable Required	Maximum Network Cable Length
ST	Short-wavelength fiber-optic (850 nm):	
	<ul style="list-style-type: none"> ■ 50 μ/125 μ multimode fiber ■ 62.5 μ/125 μ multimode fiber 	Full-duplex: 2,000 m (6,560 ft) Half-duplex: 412 m (1,351 ft)

To connect the ST port:

- 1 Remove the protective covers from the NIC's ST connector.**
- 2 Connect the network cable to the ST connector on the NIC.**

The cable that you use for the 3C900B-FL NIC consists of two individual cables. You can insert either cable into the transmit (TX) and receive (RX) connectors on the NIC.

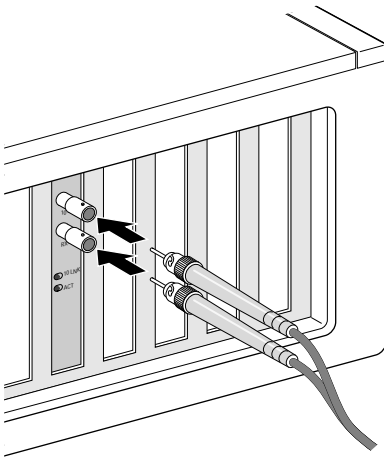

3 Connect the other end of the network cable to a 10BASE-FL Ethernet network hub or switch.

Insert the cable that is connected to the transmit (TX) connector on the NIC into the receive (RX) connector on the network hub or switch.

Insert the cable that is connected to the receive (RX) connector on the NIC into the transmit (TX) connector on the network hub or switch.

The next step is to install the network driver.

Go to [Chapter 3, "Installing NIC Software in Windows,"](#) or [Chapter 4, "Installing the NetWare Client and Server Drivers."](#)

3

INSTALLING NIC SOFTWARE IN WINDOWS

Overview

This chapter explains how to do the following tasks on a PC running Windows 95, Windows 98, or Windows NT:

- Install the network driver using *EtherCD* 5.1
- Install the NIC diagnostics program after you have already installed the network driver
- Update the network driver or NIC diagnostics program
- Install multiple NICs

To obtain the latest shipping version of a driver, go to:

<http://www.3com.com/>

The network driver can be used in both Microsoft and NetWare network environments.



For instructions on using the installation diskettes (which can be created from the EtherCD) to install the network driver, see the text file for your operating system in the HELP directory on the EtherCD.

Installing the Network Driver Using the *EtherCD*

To install the network driver using the *EtherCD*, follow the steps for your operating system.



These instructions describe how to install the network driver using the EtherCD after you have run the preinstallation program, as described in [Chapter 2](#). For instructions on installing the network driver from installation diskettes, see the text file for your operating system in the HELP directory on the EtherCD.

Before installing the network driver:

- Make sure that you have run the preinstallation program, as described in [Chapter 2](#).
- Make sure that the NIC is installed in the PC and that it is connected to the network.
- Make sure that you have the Windows installation files (Windows 95/98 only). These files may be on a CD or diskettes, or they may have been copied to your hard drive when Windows was installed on your PC.

Windows 95

To install the network driver:

1 Turn on the power to the PC.

Windows 95 detects the NIC. The Insert Disk dialog box appears, prompting you to insert the *EtherCD*.



If the New Hardware Found screen appears or the Update Device Driver Wizard starts, the NIC preinstallation program was not run on the PC. Follow the instructions in the W95NDIS.TXT file located in the Help directory on the EtherCD to continue the installation.

2 Make sure that the *EtherCD* is inserted in the CD-ROM drive.

3 Click OK.

The Copying Files dialog box appears.

4 Open the pull-down menu and select:

`c:\windows\options\cabs`

5 Click *OK*.

Files are copied.

If this is the first time that networking is being installed on your PC, the Identification tab of the Network screen appears. Go to [step 6](#).

If networking has already been installed, you are prompted for the Windows 95 CD. Go to [step 7](#).

- 6 In the specified fields of the Identification tab screen, enter the following information, and then click OK:**

Computer Name — Identifies the PC on the network for other users. This entry must be a unique name of 15 characters or fewer, containing no spaces.

Workgroup — Identifies the group (for example, your department name) to which your PC belongs. If you belong to a peer-to-peer network, this entry must be exactly the same for all the PCs in your network.

Computer Description — Displays additional details to other users on the network about this PC. For example, you could specify that the PC has a printer attached. Filling in this field is optional.

- 7 Remove the *EtherCD* from the CD-ROM drive, insert the Windows 95 CD, and then click OK.**

Files are copied. You are prompted to restart the PC.

- 8 Remove the Windows 95 CD, and then click Yes to restart the PC.**



You must restart the PC to complete the installation.

The installation is complete. Go to "[Verifying Successful Installation](#)" later in this guide to confirm that the NIC is properly installed.



After Windows restarts, double-click the Network icon in the Windows Control Panel and make sure that the correct configuration settings are selected for your network environment. Contact your system administrator for assistance.

Windows 98

To install the network driver:

- 1 Turn on the power to the PC.**

Windows 98 detects the NIC. The Insert Disk dialog box appears, prompting you to insert the *EtherCD*.



If the Add New Hardware Wizard starts, the NIC preinstallation program was not run on the PC. Follow the instructions in the WIN98.TXT file located in the Help directory on the EtherCD to continue the installation.

2 Make sure that the *EtherCD* is inserted in the CD-ROM drive.

3 Click *OK*.

The Insert Disk dialog box appears.

4 Open the pull-down menu and select:

`c:\windows\options\cabs`

5 Click *OK*.

Files are copied.



*If you are prompted for the *EtherCD*, click *OK*, make sure that the drive letter of the CD-ROM drive (for example, d:) appears in the dialog box, and then click *OK*.*

You are prompted for the Windows 98 CD.

6 Remove the *EtherCD*, insert the Windows 98 CD, and then click *OK*.

Files are copied. You are prompted to restart the PC.

7 Remove the Windows 98 CD, and then click *Yes* to restart the PC.



You must restart the PC to complete the installation.

The installation is complete. Go to the next section, "[Verifying Successful Installation](#)," to confirm that the NIC is properly installed.



After Windows restarts, double-click the Network icon in the Windows Control Panel and make sure that the correct configuration settings are selected for your network environment. Contact your system administrator for assistance.

Windows NT 4.0

To install the network driver:

- 1 Turn on the power to the PC.**
- 2 Double-click the My Computer icon, then the Control Panel icon, and then the Network icon.**

The Network window appears.

- 3 Click the Adapters tab.**

If networking has not been installed on your PC before, Windows NT asks you if you want to install networking. Click *Yes*. See the WINNT.TXT file located on the *EtherCD* or your Windows NT documentation for instructions.

- 4 Click *Add*.**

The Select Network Adapter dialog box appears.

- 5 Click *Have Disk*.**

The Insert Disk dialog box appears.

- 6 Insert the *EtherCD* in the CD-ROM drive.**

- 7 Make sure that the letter name of the CD-ROM drive (for example, d:\ appears in the entry box, and then click *OK*.**

The Select OEM Option dialog box appears.

- 8 Make sure that the 3Com EtherLink PCI NIC is selected, and then click *OK*.**

The Adapters tab of the Network screen appears.

- 9 Click *Close*.**

If the Microsoft TCP/IP Properties screen appears, enter the requested information for your network environment. Refer to your system administrator or the Windows NT documentation for assistance.

If the Microsoft TCP/IP Properties screen does not appear, the installation is complete.

- 10 Click *Yes* to restart the PC.**

The network driver installation is complete. Go to "[Verifying Successful Installation](#)" later in this chapter to confirm that the NIC is properly installed.

Windows NT 3.51

To install the network driver:

- 1 Turn on the power to the PC.**
- 2 In the Main window of the Program Manager, double-click the Control Panel icon and then the Network icon.**
- 3 Click *Add Adapter*.**

The Add Network Adapter window appears.

- 4 Open the Network Adapter Card list box, and scroll down and select *<Other> Requires disk from manufacturer*.**
- 5 Click *Continue*.**

The Insert Disk dialog box appears.

- 6 Insert the *EtherCD* in the CD-ROM drive. Make sure that *d:* appears in the entry box, where *d:* represents the letter name of the CD-ROM drive, and then click *OK*.**

The Select OEM Option window appears.

- 7 Make sure that the *name of the NIC* is selected, and then click *OK*.**

Files are copied. The Network Settings window appears. The name of the installed NIC appears in the list of installed adapter cards.

- 8 Click *OK*.**

If the TCP/IP Configuration screen appears, enter the requested information for your network environment. Refer to your system administrator or the Windows NT documentation for assistance.

If the TCP/IP Configuration screen does not appear, the installation is complete.

- 9 Restart the PC.**

The installation is complete. Go to the next section, "[Verifying Successful Installation](#)," to confirm that the NIC is properly installed.

Verifying Successful Installation

Follow the steps for your operating system.

Windows 95 and Windows 98

To verify successful NIC installation:

- 1 Open the Windows *Start* menu, select *Settings*, and then select *Control Panel*.**
- 2 Double-click the *System* icon, and then select the *Device Manager* tab.**
- 3 Double-click *Network adapters* and make sure that the name of the 3Com EtherLink NIC appears.**

If a red X or a yellow exclamation point (!) appears next to the name of the NIC, the installation was not successful. See "[Troubleshooting the NIC Installation](#)" in [Chapter 6](#) for troubleshooting help.

Windows NT 4.0

To verify successful NIC installation:

- 1 Double-click the *My Computer* icon, then the *Control Panel* icon, and then the *Network* icon.**
- 2 Select the *Adapters* tab.**
- 3 Make sure that the name of the NIC appears in the list of network adapters.**

If the name of the NIC does not appear in the list of network adapters, the installation was not successful. See "[Troubleshooting the NIC Installation](#)" in [Chapter 6](#) for troubleshooting help.

Windows NT 3.51

To verify successful NIC installation:

- 1 Double-click the *File Manager* icon.**
- 2 From the *Disk* menu, select *Connect Network Drive*.**

The presence of network server names confirms successful installation.

If you cannot connect a network drive, the installation was not successful. See "[Troubleshooting the NIC Installation](#)" in [Chapter 6](#) for troubleshooting help.

Installing the 3Com NIC Diagnostics Program

This section describes how to install the 3Com NIC Diagnostics program after you have already installed the network driver. This program is for PCs running Windows 95, Windows 98, or Windows NT 4.0.

The 3Com NIC Diagnostics program allows you to run tests that determine the status of your network, the NIC, and Remote Wake-Up. It also allows you to configure the NIC, view network statistics, and access support databases.



When you install the 3Com NIC Diagnostics program, your network driver is automatically updated to the latest version on the EtherCD.

To install the 3Com NIC Diagnostics program:

- 1 Turn on the power to the PC and start Windows.**
- 2 Insert the *EtherCD* in the CD-ROM drive.**

The *EtherCD* Welcome screen appears.

If the *EtherCD* Welcome screen does not appear, enter the following command from the Run option of the Windows Start menu:

d:\installs\setup.exe

where d:\ represents the letter name of the CD-ROM drive.

- 3 Click *NIC Software*.**
- 4 Click *NIC Drivers and Diagnostics*.**
- 5 Click *Update NIC Driver*.**
- 6 Click *Update with Diagnostic Program*.**
- 7 Select your operating system to continue the installation.**

The Completing NIC Installation screen appears.

- 8 Click *Done*.**
- 9 Exit the *EtherCD*, and then restart Windows.**

The installation is complete.

To start the 3Com NIC Diagnostics program:

- 1 **Open the Windows *Start* menu.**
- 2 **Select *Programs*, and then *3Com NIC Utilities*.**
- 3 **Click *3Com NIC Doctor*.**

For instructions on using the program, see "[Running the NIC Diagnostics Tests](#)" in [Chapter 7](#).

Updating the Network Driver and NIC Software

This section describes how to update your network driver and NIC diagnostic software.

- 1 **Turn on the power to the PC and start Windows.**
- 2 **Insert the *EtherCD* in the CD-ROM drive.**

The *EtherCD* Welcome screen appears.

If the *EtherCD* Welcome screen does not appear, enter the following command from Run option of the Windows Start menu:

d:\installs\setup.exe

where d:\ represents the letter name of the CD-ROM drive.

- 3 **Click *NIC Software*.**
- 4 **Click *NIC Drivers and Diagnostics*.**
- 5 **Click *Update*.**

To update the network driver only, click *Without Diagnostics*.

To update the network driver and NIC diagnostics software, click *With Diagnostics*.

- 6 **Follow the prompts on the screen.**

Installing Multiple NICs

This section describes how to install multiple EtherLink PCI (3C90x) NICs in a Windows 95, Windows 98, or Windows NT 4.0 PC.



You must use these procedures to install multiple NICs. Failure to follow these procedures may lead to problems requiring you to reinstall your operating system.

Windows 95 and Windows 98

To install multiple NICs in a PC running Windows 95 or Windows 98, install and configure each NIC individually, following these steps:

- 1 **Run the preinstallation program before installing the NICs in the PC, as described in [Chapter 2](#).**
- 2 **Install the first NIC in your PC and connect it to the network, as described in [Chapter 2](#).**



CAUTION: Do not physically install the second NIC in your PC until you complete the driver installation for the first NIC, following the steps below.

- 3 **Turn on the power to the PC and start Windows.**
- 4 **Insert the *EtherCD* when prompted, and then click *OK*.**
- 5 **Follow the prompts on the screen to install the network driver.**
See the "[Windows 95](#)" or "[Windows 98](#)" section earlier in this chapter for instructions.
- 6 **After the network driver is installed, restart the PC.**
- 7 **After the PC restarts, exit Windows and turn the power off to the PC. Make sure that the PC is unplugged.**

- 8 **Install the second NIC in your PC and connect it to the network.**
- 9 **Plug in the PC power cord, turn on the power to the PC, and then start Windows.**

Windows detects the second NIC. The second NIC uses the same network driver as the first NIC. You are not prompted for the *EtherCD*.

When Windows starts, the second NIC appears under *Network adapters* in the Device Manager.

- 10 **Repeat the process for each additional NIC to be installed.**

Windows NT 4.0

To install multiple NICs in a PC running Windows NT 4.0:

- 1 Install the NICs in your PC and connect each to the network.**
- 2 Turn on the power to the PC and start Windows NT.**
- 3 Double-click the My Computer icon, then the Control Panel icon, and then the Network icon.**

The Network screen appears.
- 4 Select the Adapters tab.**
- 5 Click *Add*.**

The Select Network Adapter screen appears.
- 6 Click *Have Disk*.**
- 7 Insert the *EtherCD*.**
- 8 Make sure that d:\ appears in the entry box (where d:\ represents the letter name of the CD-ROM drive), and then click *OK*.**

The Select OEM Option screen appears with the name of one of the NICs selected. Only one NIC appears on this screen.
- 9 Click *OK*.**

Files are copied. The Network screen appears with the name of the first installed NIC.
- 10 Close the Network screen.**

If you are prompted for network information, enter the requested information.
- 11 Restart the PC.**
- 12 When Windows NT starts, repeat steps 3 through 11 for each NIC that is installed in the PC.**



You will not be prompted for the EtherCD when you install the network driver for the second NIC.

4

INSTALLING THE NETWARE CLIENT AND SERVER DRIVERS

Overview

This chapter describes how to:

- Install the Novell NetWare client driver for DOS, Windows 3.1, or Windows for Workgroups.
- Install the NetWare 3.x, 4.x, and 5.x server drivers.

To obtain the latest shipping version of a driver, go to:

<http://www.3com.com/>

Installing the NetWare Client Driver

The NetWare client driver enables PCs running DOS, Windows 3.x, or Windows for Workgroups to access resources on a NetWare 3.x, 4.x, or 5.x network.

Use the 3Com intelligent auto install software (COMSLINK) to install the client software and drivers for Novell NetWare 3.x, 4.x, or 5.x.



Do not use the intelligent auto install software if you are running Windows 95, Windows 98, or Windows NT. See "[Installing NIC Software in Windows](#)" for procedures to install network drivers under these operating systems.

About 3Com Intelligent Auto Install Software

The 3Com intelligent auto install software automatically configures your NIC and PC for use as a NetWare client.

The intelligent auto install software creates a new AUTOEXEC.BAT file and saves the old file as AUTOEXEC.3CM. It also creates a new CONFIG.SYS file and saves the old file as CONFIG.3CM.

The 3Com intelligent auto install software does not support Japanese versions of DOS and Windows 3.1x.

Intelligent Auto Install Requirements

To use the intelligent auto install program:

- Make sure that your PC has only one EtherLink PCI NIC installed.
- Make sure that you are using NetWare 3.x, 4.x, or 5.x as your network operating system.
- Make sure that your PC has at least 1 MB of available hard drive space.

Running the Intelligent Auto Install Software

To run the intelligent auto install software to install the client software and drivers for a NetWare network:

- 1 **Install the NIC and connect it to the network, as described in Chapter 2.**
- 2 **Reboot to DOS.**
- 3 **Insert the *EtherCD* in the CD-ROM drive.**
- 4 **At the DOS prompt, enter the following command, where d is the drive letter of your CD-ROM drive:**
d:install
The main menu appears.
- 5 **Select *Auto Install and Config for NetWare* and press Enter.**
- 6 **Select *DOS, Windows 3.1x, or Windows for Workgroups 3.11*, and follow the instructions.**
- 7 **When the installation process is finished, remove the *EtherCD* and reboot the PC.**



If you are running Windows 3.1x, after you connect to the NetWare server, run the WSINSTALL program for full Windows support. Contact your system administrator for the location of this NetWare utility.

Installing the NetWare Server Driver

This section describes how to install the NetWare driver on a Novell server running NetWare 3.x, 4.x, or 5.x.



The EtherLink PCI NICs do not support NetWare 3.xx or 4.xx servers that are not updated to the latest driver pack.

The \NWSERVER\NW3.x directory contains the network driver file (3C90X.LAN) to be used for servers running NetWare 3.x.

The \NWSERVER directory contains the network driver file (3C90X.LAN) to be used for servers running NetWare 4.x or 5.x.

Additional files (NetWare Loadable Modules [NLMs]) that are required for servers running NetWare are on the *EtherCD* in the \NWSERVER directory, or they can be obtained from Novell.

Obtaining NetWare Loadable Modules

You can obtain current NLMs for the NetWare servers listed in the table below from the Novell World Wide Web site:

<http://www.support.novell.com>

NetWare Server	NLM Name
NetWare 3.12	ETHERTSM.NLM
	NBI31.NLM
	MSM31X.NLM
NetWare 4.10, 4.11	ETHERTSM.NLM
	NBI.NLM
	MSM.NLM
NetWare 5.x	ETHERTSM.NLM
	MSM.NLM

NetWare 3.12

To install the driver in a NetWare 3.12 server:

- 1 **Copy the MSM31X.NLM, ETHERTSM.NLM, and NBI31.NLM files from the *EtherCD* to the directory on your hard drive where other NLM files are located.**
- 2 **Copy the LAN driver file (3C90X.LAN) from the *EtherCD* to the same directory.**
- 3 **Add the following two lines to the AUTOEXEC.NCF file:**

```
load C:\NWSERVER\3C90X.LAN slot=<slot>
NAME=<name> FRAME=<frametype>
bind ipx to <name> net=<number>
```
- 4 **Save and exit the file, and then reboot the server.**

NetWare 4.x

There are two ways to install the NetWare 4.x driver:

- Import the driver when installing the NetWare server software.
- Copy the driver to the server's hard disk, and then load the driver manually.



*Make sure that you have the latest NetWare Support Pack installed. that changes the LOADER.EXE file and provides the NBI.NLM, MSM.NLM, and ETHERTSM.NLM files. 3Com has provided the latest *.NLM files (at time of testing) on the EtherCD in the INWSERVER directory.*

Importing the Server Driver

To import the server driver into a NetWare 4.x server:

- 1 **Install the NetWare server software.**
- 2 **Insert the *EtherCD* in the CD-ROM when the NIC selection menu appears.**
- 3 **Press [Insert].**

This key tells the server installation program that you want to add a driver externally.
- 4 **Press [F3].**

This key tells the server installation program that you want to change the path.

5 At the prompt, enter the command:**NWSERVER**

For example:

a:\nwserver

The installation program gathers the files and prompts you for a NIC selection.

6 Press [Enter] to select the driver displayed and continue the installation.**Loading the Driver Manually**

To update an existing server driver manually:

- 1 Copy all of the files from the \NWSERVER subdirectory on the *EtherCD* to the server's hard drive.**
- 2 Boot the server and launch the Install program.**
- 3 Edit the AUTOEXEC.NCF file to add the following line (assuming the server start directory is C:\NWSERVER, where the LAN drivers and NLM files were copied):**

```
LOAD C:\NWSERVER\3C90X.LAN
SLOT=<slotnumber>
```

The <slotnumber> variable is the hexadecimal slot number of the PCI NIC. See "[Verifying the PCI Slot Number](#)" for instructions on obtaining this number.

NetWare 5.x

There are two ways to install the NetWare 5.x driver:

- Import the driver when installing the NetWare server software.
- Copy the driver to the server's hard disk, and then load the driver manually.

Importing the Server Driver

To import the server driver into a NetWare 5.x server:

- 1 Install the NetWare server software.**
- 2 Press [ESC] when the new hardware screen appears.**
- 3 Insert the *EtherCD* in the CD-ROM when the NIC selection menu appears.**

4 Press [Insert].

This key tells the server installation program that you want to add a driver externally.

5 Press [F3].

This key tells the server installation program that you want to change the path.

6 At the prompt, enter the following command:

NWSERVER

For example:

a:\nwserver

The installation program gathers the files and prompts you for a NIC selection.

7 Press [Enter] to select the driver displayed and continue the installation.**Loading the Driver Manually**

To update an existing server driver manually:

- 1 Copy all of the files from the \NWSERVER subdirectory on the *EtherCD* to the server's hard drive.**
- 2 Boot the server and launch the Install program.**
- 3 Add the following line to the AUTOEXEC.NCF file (assuming the server start directory is C:\NWSERVER, where the LAN drivers and NLM files were copied):**

```
LOAD C:\NWSERVER\3C90X.LAN  
SLOT=<slotnumber>
```

The <slotnumber> variable is the hexadecimal slot number of the PCI NIC. This address can be obtained by issuing a load command, where the driver identifies the slot numbers. Pressing Esc prevents loading the driver. Because of Novell's scheme for identifying PCI slots, it is not possible for 3Com to pre-identify the slot number.

Installing Multiple NICs

To support more than one NIC in a NetWare server, change the AUTOEXEC.NCF file to the following format:

```
load C:\NWSERVER\3C90X.LAN slot=<slot1>
NAME=<name1> FRAME=<frametype1>
bind ipx to <name1> net=<net1>
load C:\NWSERVER\3C90X.LAN slot=<slot2>
NAME=<name2> FRAME=<frametype2>
bind ipx to <name2> net=<net2>
```

The values <slot1> and <slot2> are the numbers of the PCI slots in which the NICs are physically installed. To view the numbers of these PCI slots, use the 3Com Configuration and Diagnostic program for DOS. See the next section, "[Verifying the PCI Slot Number](#)," for instructions.

The values <name1> and <name2> are unique names assigned to each NIC by your system administrator. The values <name1> and <name 2> must be different.

The frame parameters <frametype1> and <frametype2> can be one of the following:

- Ethernet_802.2
- Ethernet_802.3
- Ethernet_II
- Ethernet_SNAP

Make sure that the frametype for the server and the workstation is the same. For example, if the server uses Ethernet_802.2, the workstation must also use Ethernet_802.2.

The values <net1> and <net2> are unique numbers assigned by the system administrator to each NIC. Make sure that <net1> and <net2> are different numbers.

See the appropriate Novell NetWare manuals for further information.

Verifying the PCI Slot Number

To verify the PCI slot number in which a NIC is installed:

1 **Boot the NetWare server with the -na option.**

This prevents the AUTOEXEC.NCF file from loading. For example, enter:

```
server -na
```

2 **Issue the load command for the NIC LAN driver without a slot parameter.**

For example, enter:

```
load c:\nwserver\3c90x.lan
```

3 **NetWare lists the valid slot number(s) for the NIC, depending on how many NICs are installed. The values appearing in the list are the slot values that you should use.**

5

CONFIGURING THE NIC

Overview

This chapter describes how to configure the NIC.



Before you change the NIC configuration settings, contact your system administrator.

Default NIC Settings

The table below lists the configuration settings for the NIC. The default setting is in bold in the Settings column.

Option	Description	Settings
Network Driver Optimization	<p>Specifies how to optimize the network driver for your network by allowing trade-offs between network performance and CPU utilization.</p> <ul style="list-style-type: none">■ <i>Normal</i> balances CPU utilization and network performance.■ <i>Minimized CPU Utilization</i> saves CPU resources for other tasks.■ <i>Maximized Network Performance</i> is appropriate if no other applications are making major demands on CPU resources.	<ul style="list-style-type: none">■ Normal■ Minimized CPU Utilization■ Maximized Network Performance
Duplex	<p>Determines if the NIC transmits data across the network in both directions simultaneously (full-duplex) or in one direction at a time (half-duplex).</p> <ul style="list-style-type: none">■ <i>Auto Select</i> allows the NIC to automatically connect at the duplex mode of the connected hub or switch. When you select this setting, the <i>Media Type</i> is automatically set to <i>Auto Select</i>.■ <i>Full-Duplex</i> sets the NIC to operate in full-duplex mode. To use this setting, the switch that you are connected to must support full-duplex. You must also manually set the NIC <i>Media Type</i> setting.■ <i>Half-Duplex</i> sets the NIC to operate in half-duplex mode. You must also set the NIC <i>Media Type</i> setting.	<ul style="list-style-type: none">■ Auto Select■ Full-Duplex■ Half-Duplex

(continued)

Option	Description	Settings
Boot PROM	Enables or disables the NICs boot ROM (if a boot ROM is installed on the NIC).	<ul style="list-style-type: none"> ■ Enabled ■ Disabled
Media Type	Determines the type of media your network is using. <ul style="list-style-type: none"> ■ <i>Auto Select</i> allows the NIC to automatically select the Media Type for you. ■ If you set the NIC <i>Duplex</i> setting to <i>Auto Select</i>, the <i>Media Type</i> is automatically set to <i>Auto Select</i>. ■ If you set the NIC <i>Duplex</i> setting manually, you must set the <i>Media Type</i> setting manually. 	<ul style="list-style-type: none"> ■ Auto Select ■ 10BASE-T (10Mb/s) ■ 100BASE-TX (100Mb/s) ■ AUJ ■ BNC ■ 100BASE-FX ■ 10BASE-FL

Configuration Methods

The NIC can be configured using any of the methods listed in the table below.



This chapter describes how to configure the NIC using the 3Com NIC Diagnostics program for Windows. For instructions on using the other two methods, see the file or appendix mentioned in the table.

Method	Description	Requirement(s)
3Com NIC Diagnostics program for Windows	Configure the NIC locally using the 3Com NIC Diagnostics program for Windows: <ol style="list-style-type: none"> 1 Make sure that the 3Com NIC diagnostics program is installed. See "Installing the 3Com NIC Diagnostics Program" in Chapter 3 for instructions. 2 Open the Windows <i>Start</i> menu. 3 Select <i>Programs</i>, and then <i>3Com NIC Utilities</i>. 4 Click <i>3Com NIC Doctor</i>. 	Windows 98, Windows 95, or Windows NT 4.0

(continued)

Method	Description	Requirement(s)
3Com Configuration and Diagnostics program for DOS	<p>Configure the NIC locally using the 3Com Configuration and Diagnostics program for DOS:</p> <ol style="list-style-type: none"> 1 Reboot the PC using a DOS-bootable diskette. 2 Insert the <i>EtherCD</i> in the PC. 3 Enter at the DOS prompt: d:\3c90xcfg.exe <p>See the DOSDIAG.TXT file located in the HELP directory on the <i>EtherCD</i> for more information.</p> <p>Customers running Japanese DOS must switch to U.S. mode DOS before running this program.</p>	DOS, Windows NT 3.51, Windows 3.x, or Windows for Workgroups
DMI 2.0 or 2.0s	<p>Configure the NIC remotely using the 3Com DMI Agent software.</p> <p>See Appendix C, "Installing the 3Com DMI Agent" for more information.</p>	3Com DMI Agent and a DMI-compatible browser or a network management application that supports DMI 2.0 or 2.0s

Changing General NIC Configuration Settings

Before you configure the NIC, make sure that:

- The NIC is installed in the PC and is connected to the network.
- The network driver is installed.
- The 3Com NIC Diagnostics program is installed.

To change the NIC general configuration settings, such as network driver optimization, duplex mode, and media type:

- 1 **Open the Windows *Start* menu.**
- 2 **Select *Programs*, and then *3Com NIC Utilities*.**
- 3 **Click *3Com NIC Doctor*.**

The 3Com NIC Diagnostics General screen appears.



Click Help to obtain general information about the function of a screen. To obtain specific information about any topic on a screen, click the question mark (?) in the upper right corner of the screen, move it over a topic, and click once.

- 4 If your PC has more than one NIC installed, open the Network Interface Card (NIC) list box and select the NIC to be configured.**

- 5 Click the Configuration tab.**

The Configuration screen appears.

- 6 Under Network Parameter, select the setting to be changed.**

For a description of each setting, click the question mark (?) in the upper right corner of the screen, move it over a setting, and click once.

- 7 Open the Set Value list box and select a new value from the list of available options.**

Repeat the process to change any other configuration setting.

To undo changes and return the settings to their previous values, click *Undo Changes*.

To return the settings to the factory default settings, click *Set Factory Defaults*.

- 8 Click *OK* to save the changes and exit the program.**

Configuring the Managed PC Boot Agent (MBA)

This section explains how to configure the 3C905C-TX-M and 3C905B-TX-M NICs' Managed PC Boot Agent (MBA) boot ROM to boot from the network.



For detailed information on using, configuring, and troubleshooting the MBA boot ROM, see the Managed PC Boot Agent User Guide, located with the MBA software on the EtherCD.

Enabling or Disabling the Boot ROM Setting

The default NIC boot ROM setting is *Enabled*. This setting must be enabled to boot from the network.

To enable or disable the NIC boot ROM setting:

- 1 Make sure that the NIC is installed and is connected to the network and that the NIC driver is installed.**
- 2 Open the Windows *Start* menu.**
- 3 Select *Programs*, and then *3Com NIC Utilities*.**
- 4 Click *3Com NIC Doctor*.**
The 3Com NIC Diagnostics General screen appears.
- 5 Click the *Configuration* tab.**
The Configuration screen appears.
- 6 Under *Network Parameter*, select *Boot PROM*.**
- 7 Open the *Set Value* list box and select *Enabled* to enable the boot ROM or *Disabled* to disable the boot ROM.**
- 8 Click *OK* to save the setting and exit the program.**

Booting From the Network

The boot process for the MBA boot ROM varies depending on the type of PC you have (BBS BIOS-compatible or non-BBS BIOS-compatible).

If your PC was purchased recently, it may be BBS (BIOS Boot Specification) BIOS-compatible. The BBS determines how the system BIOS identifies boot devices in a PC (such as a CD-ROM drive, a hard drive, or a floppy drive), allows the user to select the boot order of these devices, and then attempts to boot from each device in the specified order.

Refer to your PC documentation if you do not know which type of PC you have.

BBS BIOS-Compatible PCs

To enable a BBS BIOS-compatible PC to boot from the network using the MBA boot ROM:

1 Make sure that the NIC boot ROM setting is *Enabled*.

See the previous section, "[Enabling or Disabling the Boot ROM Setting](#)," for instructions.

2 Set the MBA manually as the first boot device in the PC BIOS.

Refer to your PC documentation for instructions on accessing and configuring the PC BIOS.

3 Reboot the PC.

The MBA attempts to boot from the network using the default boot method PXE.

To change the default method or any other MBA configurations, press Ctrl+Alt+B when the following message appears:

```
Initializing MBA. Press Ctrl+Alt+B to
configure...
```

If the network boot fails, the following message appears:

```
Network boot aborted, press any key to
continue
```

The BIOS continues to the next device in the boot order (for example, the local hard drive).



To cancel the network boot, press Esc anytime during the network boot process

Non-BBS BIOS-Compatible PCs

To enable a non-BBS BIOS-compatible PC to boot from the network using the MBA boot ROM:

1 Make sure that the NIC boot ROM setting is *Enabled*.

See “[Enabling or Disabling the Boot ROM Setting](#)” earlier in this chapter for instructions.

2 Change the MBA default boot setting from *Local* to *Network*.

To change the default boot setting or any other MBA configurations, use the MBACFG utility located on the MBA utility diskette or press Ctrl+Alt+B when the following message appears:

```
Initializing MBA. Press Ctrl+Alt+B to  
configure...
```



For more information on using, configuring, and troubleshooting the MBA boot ROM, see the Managed PC Boot Agent User Guide, located with the MBA software on the EtherCD.

6

TROUBLESHOOTING THE NIC

Overview

This chapter explains how to:

- Access 3Com support databases.
- Troubleshoot NIC installation problems.
- Troubleshoot NIC and network connection problems.
- Troubleshoot Remote Wake-Up.
- Remove the network driver.
- Remove the NIC diagnostics software.



To access a database of technical information that can help you diagnose and solve NIC installation, configuration, and upgrade problems, go to:

<http://knowledgebase.3com.com>

Accessing 3Com Support Databases

In addition to the 3Com support databases listed in this section, check the README.TXT and the Help text files located in the HELP directory on the *EtherCD* for troubleshooting information.

Accessing the 3Com Knowledgebase

To access a database of technical information that can help you diagnose and solve NIC installation, configuration, and upgrade problems, go to:

<http://knowledgebase.3com.com>

Accessing the 3Com NIC Help System

To access the 3Com NIC Help system:

- 1 Make sure that the NIC, its driver, and the 3Com NIC Diagnostic program are installed.**
See "[Installing the 3Com NIC Diagnostics Program](#)" for instructions.
- 2 Open the Windows *Start* menu.**
- 3 Select *Programs*, and then *3Com NIC Utilities*.**
- 4 Select *3Com NIC Doctor Help*.**
The main Help screen appears.
- 5 Click *Help Topics* to display a list of Help topics or click *Find* to search for a Help topic.**

Accessing Release Notes and Frequently Asked Questions

To access release notes and frequently asked questions about the NIC:

- 1 Make sure that the NIC, its driver, and the 3Com NIC Diagnostic program are installed.**
See "[Installing the 3Com NIC Diagnostics Program](#)" for instructions.
- 2 Open the Windows *Start* menu.**
- 3 Select *Programs*, and then *3Com NIC Utilities*.**
- 4 Click *3Com NIC Doctor*.**
The 3Com NIC Diagnostics General screen appears.
- 5 Click the *Support* tab.**
The Support screen appears.
- 6 Click *Support Databases* to display customer support databases about the NIC in three categories:**
 - Release notes** — Display tips about installing and using the NIC.
 - Frequently asked questions** — Display common questions asked by customers and answered by 3Com support experts.
 - Knowledgebase topics** — Display NIC compatibility topics.

Troubleshooting the NIC Installation

If you encounter any of the following problems or error messages, follow the steps under "[Cleaning Up a Failed Installation](#)" to resolve the problem.

Problems/Error Messages

- A red X or a yellow exclamation point (!) appears next to the name of the NIC in the Windows Device Manager.
- The Network Neighborhood icon does not appear on the Windows desktop.
- The NIC does not appear in the Network Configuration or Properties window.
- Error: "This device is not present, not working properly, or does not have all of the driver installed. Code 22."
- Error: "Windows was unable to locate a driver for this device."
- Error: "You have selected a plug and play adapter. Please turn off your machine and install the adapter. Then turn on your machine and reinstall."

Cleaning Up a Failed Installation

If the network driver installation failed, follow the steps below to clean up your system and install the NIC correctly.

This procedure:

- Removes all 3C90x NICs from your system.
- Removes the 3Com NIC Diagnostics program.
- Installs the latest network driver.

You can reinstall the 3Com NIC Diagnostics program after completing this procedure. See "[Installing the 3Com NIC Diagnostics Program](#)" in [Chapter 3](#) for instructions.

1 Insert the *EtherCD* in the CD-ROM drive.

The *EtherCD* Welcome screen appears.

2 Click *Drivers*, and then click *Utilities*.

3 Click *Clean Up Failed Installation*.

4 Click *Proceed*.

A warning message appears.

5 Click *OK*.

A message appears stating that all of the EtherLink NICs have been removed from your system.

6 Click *OK*.**7 Exit the *EtherCD*, and then exit Windows.****8 Reboot the PC.****9 Install the network driver, as described in “[Installing the Network Driver Using the EtherCD](#)” in [Chapter 3](#).**

If you are prompted for 3Com files when Windows restarts, open the drop-down box and select the following path:

```
\options\cabs
```

To verify successful installation, see “[Verifying Successful Installation](#)” in [Chapter 3](#).

Troubleshooting the Network Connection

If you encounter problems with using the NIC or connecting to the network, check the table below for troubleshooting tips.



CAUTION: Before inserting or removing the NIC from the PC, turn the PC power off and unplug the power cord.

Tip	Description
Check the NIC installation	<ul style="list-style-type: none"> ■ Make sure that you have run the preinstallation program, as described in Chapter 2. This program must be run <i>before</i> installing the NIC in the PC. ■ Make sure that the NIC is installed correctly in a PCI slot. Check for specific hardware problems, such as broken traces or loose or broken solder connections.
Check the network connection	<ul style="list-style-type: none"> ■ Inspect all cables and connections. Make sure that the cable complies with its proper length and specifications, as described in Chapter 2.
Check your PC BIOS	<ul style="list-style-type: none"> ■ Make sure that you are running the latest BIOS for your PC. If your BIOS has not been upgraded in the previous 12 months, contact your PC manufacturer to obtain the current version of your BIOS software.

(continued)

Tip	Description
Run the NIC diagnostic tests	<ul style="list-style-type: none"> ■ Run the NIC and Network Tests, as described in “Running the NIC Diagnostics Tests” in Chapter 7. <p>If the tests fail, replace the NIC with a known working NIC and run the tests again, using the same configuration settings as those used on the failed NIC. If the working NIC passes all tests, the original NIC is probably defective. For information on product repair, see Appendix D.</p>
Check the 3Com support databases	<p>Review the known problems and solutions found in the following areas:</p> <ul style="list-style-type: none"> ■ 3Com Knowledgebase ■ 3Com NIC Help system ■ Release Notes and Frequently Asked Questions <p>See “Accessing 3Com Support Databases” earlier in this chapter for instructions on using these databases.</p>
Download the latest NIC driver	<p>Download and install the latest NIC driver from: http://www.3com.com/</p>
Run the <i>Clean Up Failed Installation</i> program	<p>The <i>Clean Up Failed Installation</i> program is located on the <i>EtherCD</i>. See “Cleaning Up a Failed Installation” earlier in this chapter for instructions.</p>

Troubleshooting Remote Wake-Up

If your PC does not boot in response to a Remote Wake-Up event, perform these troubleshooting steps:

- 1 Make sure that the PC meets the Remote Wake-Up requirements listed in Chapter 1.**
- 2 Make sure that you are using the latest driver for the NIC.**

This driver is shipped with the NIC on the *EtherCD*. It can also be downloaded from:

<http://www.3com.com/>

- 3 Perform the Remote Wake-Up Test.**

See “[Running the NIC Diagnostics Tests](#)” in [Chapter 7](#) for instructions.

- 4 Check the PC BIOS.**

- a** Boot the PC and enter the BIOS.

If you do not know how to enter the BIOS, consult the reference manual for your PC or contact your PC vendor.

- b Locate the Wake-Up on LAN event setting.
- c Verify that the setting is enabled.

5 Check the Remote Wake-Up cable connection.



If you have a 3C905C-TX-M NIC and your PC is compliant with PCI 2.2, the Remote Wake-Up cable is not required. Remote Wake-Up is automatically enabled through the PCI bus.

- a Turn off the power to the PC and remove the PC cover.
 - b Make sure that the Remote Wake-Up cable is plugged in to the RWU connector on the NIC and in to the appropriate connector on the PC motherboard. Unplug and reinsert the cable if necessary.
 - c Replace the Remote Wake-Up cable with a known functioning Remote Wake-Up cable and perform the Remote Wake-Up Test again.
- ## 6 If the previous steps have failed, install a known functioning Remote Wake-Up NIC in the PC.

If Remote Wake-Up works with the new NIC installed, contact your PC vendor for a replacement NIC.

If Remote Wake-Up does not work with the new NIC installed, there may be a problem with the PC motherboard. Contact your PC manufacturer.

Removing the Network Driver

To remove the EtherLink (3C90x) network driver from your PC, follow the steps for your operating system.

Windows 95 and Windows 98

To remove the network driver:

- 1 **Double-click the My Computer icon, then the Control Panel icon, and then the System icon.**
- 2 **Click the Device Manager tab.**
- 3 **Double-click *Network adapters*.**
- 4 **Highlight the name of the NIC.**
- 5 **Click *Remove*.**

6 Click *OK* to confirm the device removal.

You are prompted to restart the PC.

If you are physically removing the NIC from the PC, click *No*. Do not restart the PC until you shut down the system, turn the power off, and remove the NIC from the PC.

If you are reinstalling the NIC software, click *Yes* to restart the PC.

Windows NT 4.0

To remove the network driver:

1 Double-click the My Computer icon, then the Control Panel icon, and then the Network icon.

The Network screen appears.

2 Click the Adapters tab.**3 Highlight the name of the NIC in the Network Adapters box, and then click *Remove*.****4 Click *Yes* to confirm the removal.****5 Click *Close* to close the Network screen.**

You are prompted to restart the PC.

If you are physically removing the NIC from the PC, click *No*. Do not restart the PC until you shut down the system, turn the power off, and remove the NIC from the PC.

If you are reinstalling the NIC software, click *Yes* to restart the PC.

Windows NT 3.51

To remove the network driver:

1 In the Main program window, double-click the Control Panel icon, and then double-click the Network icon.

The Network Settings window appears.

2 In the Installed Adapter Cards panel, select the name of the installed NIC, and then click *Remove*.

A warning message appears.

3 Click Yes to confirm the removal.

The Network Settings window appears. The NIC no longer appears in the Installed Adapter Cards panel.

4 Click OK.

The NIC driver and software are removed from the PC. You are prompted to restart the PC.

If you are physically removing the NIC from the PC, click *Don't Restart Now*. Do not restart the PC until you shut down the system, turn the power off, and remove the NIC from the PC.

If you are reinstalling the NIC software, click *Restart Now* to restart the PC.

Removing the 3Com NIC Diagnostics Program

To remove the 3Com NIC Diagnostics program:

1 Start Windows.**2 Insert the *EtherCD* in the CD-ROM drive.**

The *EtherCD* Welcome screen appears.

If the *EtherCD* Welcome screen does not appear, enter the following command from the Run option of the Windows Start menu:

d:\installs\setup.exe

where d:\ represents the letter name of the CD-ROM drive.

3 Click *NIC Drivers*.**4 Click *Utilities*.****5 Click *Remove Diagnostics*.****6 Follow the prompts on the screen.**

7

RUNNING NIC DIAGNOSTICS

Overview

This chapter explains how to:

- Interpret the NIC LEDs.
- Run the NIC diagnostic tests.
- View network statistics.
- Use the 3Com icon in the Windows system tray.

Interpreting the LEDs

The EtherLink PCI NICs have light-emitting diodes (LEDs), as described in the following table, that can assist with network troubleshooting.

Some LNK LED states do not apply to the AUI, BNC, SC, and ST connectors, as indicated by *N/A* in the table.

LED	State	Meaning	Connector				
			RJ-45	AUI	BNC	SC	ST
10 LNK (link)	On	If drivers are installed, the 10BASE-T connection is active.	Yes	N/A	N/A	N/A	Yes
		If drivers are not installed, the NIC is receiving power.	Yes	Yes	Yes	N/A	Yes
	Off	Something is preventing the connection between the NIC and the hub or switch.	Yes	N/A	N/A	N/A	Yes
	Blinking	The cable polarity is reversed. Try a different network cable or contact your system administrator.	Yes	N/A	N/A	N/A	N/A

(continued)

LED	State	Meaning	Connector				
			RJ-45	AUI	BNC	SC	ST
100 LNK (link)	On	If drivers are installed, the 100BASE-TX or 100BASE-FX connection is active.	Yes	N/A	N/A	Yes	N/A
		If drivers are not installed, the NIC is receiving power.	Yes	Yes	Yes	Yes	N/A
	Off	Something is preventing the connection between the NIC and the hub or switch.	Yes	N/A	N/A	Yes	
	Blinking	The cable polarity is reversed. Try a different network cable or contact your system administrator.	Yes	N/A	N/A	N/A	N/A
ACT (activity)	Blinking	Network traffic is present.	Yes	Yes	Yes	Yes	Yes
	Steady	Heavy network traffic is present.	Yes	Yes	Yes	Yes	Yes
	Off	No network traffic is present.	Yes	Yes	Yes	Yes	Yes

If a LNK LED indicates a problem, check the following:

- 1 Ensure that your network hub or switch and the cable connecting to your NIC comply with the specifications appropriate for your network connection.**
- 2 Ensure that the hub or switch is powered on.**

Running the NIC Diagnostics Tests

The 3Com NIC Diagnostics program for Windows contains tests that can check the status of the following items:

- Network
- NIC
- Remote Wake-Up



To run NIC diagnostic tests on a PC running DOS, Windows NT 3.51, Windows 3.x, or Windows for Workgroups, use the 3Com Configuration and Diagnostics program for DOS. See the DOSDIAG.TXT file located in the HELP directory on the EtherCD for instructions.

To run the NIC Test, Network Test, or Remote Wake-Up Test:

- 1 Make sure that the NIC, the network driver, and the 3Com NIC Diagnostics program are installed.**
- 2 Open the Windows *Start* menu.**
- 3 Select *Programs*, and then *3Com NIC Utilities*.**
- 4 Click *3Com NIC Doctor*.**

The 3Com NIC Diagnostics General screen appears.



Click Help to obtain general information about the function of a screen. To obtain specific information about any topic on a screen, click the question mark (?) in the upper right corner of the screen, move it over a topic, and click once.

- 5 Click the Diagnostics tab.**

The Diagnostics screen appears.



If the Run Remote Wake-Up Test button appears dimmed, the NIC that is installed in the PC does not support Remote Wake-Up.

To Run the Network Test

Run the Network Test to check the NIC connectivity to the network.

- 1 Click *Run Network Test* on the Diagnostics screen.**

The Network Connectivity Test screen appears.

2 Click *Start*.

If the test passes, the NIC connection to the network is functioning correctly.

If the test fails:

Make sure that the NIC is properly connected to the network cable.

Make sure that the hub or switch to which the NIC is connected is powered on.

Make sure that the cable complies with the proper length and specifications for your network.

3 Click *Close*.**To Run the NIC Test**

Run the NIC Test to check the physical components, connectors, and circuitry on the NIC.

1 Click *Run NIC Test on the Diagnostics* screen.

The NIC Test screen appears.

2 Click *Perform NIC Test*.

While the test is running, a progress bar indicates test progress.

If the test passes, the NIC is functioning correctly.

If the test fails, a message indicates the error type. Click *Help* in the error message screen to obtain more information.

3 Click *Close*.**To Run the Remote Wake-Up Test**

At least two PCs on your network must contain a 3Com NIC with *EtherDisk* 4.x or later software to run the Remote Wake-Up Test.

1 Click *Run Remote Wake-Up Test on the Diagnostics* screen.

If the Run Remote Wake-Up Test button appears dimmed, the NIC does not support Remote Wake-Up.

The Remote Wake-Up Test screen appears.

2 Enter the number of seconds in the Seconds Until Wakeup entry box that the PC remains shut down until it receives a Wake-Up packet from the first PC.

3 Click *Test Remote Wake-Up*.

The PC shuts down.

If the PC automatically powers on after the number of seconds specified in the Seconds Until Wakeup entry box, Remote Wake-Up is functioning correctly.

If the PC does not power on, Remote Wake-Up is not functioning. See “[Troubleshooting Remote Wake-Up](#)” in [Chapter 6](#) for more help.

Viewing Network Statistics

To view statistical information about the network:

1 Make sure that the NIC, the network driver, and the 3Com NIC Diagnostics program are installed.

2 Open the Windows *Start* menu.

3 Select *Programs*, and then *3Com NIC Utilities*.

4 Click *3Com NIC Doctor*.

The 3Com NIC Diagnostics General screen appears.

5 Click the *Statistics* tab.

The Statistics screen appears.

The information is updated by the NIC driver every 5 seconds.

For a description of each statistic, click the question mark (?) in the upper right corner of the screen, drag it over a statistic and click once. A pop-up box appears, displaying information about the statistic.

6 Click *OK* to exit the diagnostics program. To go to another diagnostics screen, click the associated tab.

Using the 3Com Icon in the Windows System Tray

If the 3Com icon is visible in the Windows system tray, double-click the icon to start the 3Com NIC Diagnostics program.



If a red circle with a line through it appears over the 3Com icon, there is no connection between the NIC and the network. See "[Troubleshooting the Network Connection](#)" in [Chapter 6](#) for help.

To show the 3Com icon in the Windows system tray:

- 1 Make sure that the NIC, the network driver, and the 3Com NIC Diagnostics program are installed.**
 - 2 Open the Windows *Start* menu.**
 - 3 Select *Programs*, and then *3Com NIC Utilities*.**
 - 4 Click *3Com NIC Doctor*.**
- The 3Com NIC Diagnostics General screen appears.
- 5 On the *General* screen, select the check box next to *Show Icon in System Tray*.**
 - 6 Close the 3Com NIC Diagnostic program.**

When you drag your mouse pointer over the 3Com icon (but do not double-click the icon) a network statistics box appears, displaying the following information:

Frames Sent and Received — A count of the number of frames (packets) sent and received through the NIC since the last time statistics were reset.

Link Speed — The speed (10 Mbps or 100 Mbps) at which the NIC is connected to the network.

The information is updated each time you move your mouse pointer over the 3Com icon.

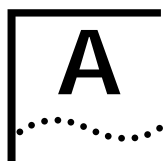

SPECIFICATIONS AND CABLING REQUIREMENTS

This appendix lists the specifications, standards conformance, cable requirements, and connector pin assignments for the EtherLink PCI NICs.

3C905C-TX-M NIC Specifications

Hardware

Bus interface	<i>PCI Local Bus Specification, Revision 2.2</i> 32-bit bus
PCI master	Supports bus master scatter-gather DMAs.
Dimensions	Height: 7.62 cm (3.00 in) Length: 14.86 cm (5.85 in)
Power requirement	+5 V \pm 5% @ 650 mA maximum

Network Interface

10 Mbps Ethernet 10BASE-T	Ethernet IEEE 802.3 industry standard for a 10 Mbps baseband CSMA/CD local area network
100 Mbps Ethernet 100BASE-TX	Ethernet IEEE 802.3u industry standard for a 100 Mbps baseband CSMA/CD local area network

Environment

Operating temperature	32° to 158° F (0° to 70° C)
Storage temperature	-22° to 194° F (-30° to 90° C)
Operating humidity	10 to 90% noncondensing
Storage humidity	10 to 90% noncondensing
Altitude	-984 ft to 9,840 ft (-300 to 3,000 m)

Standards Conformance

IEEE 802.3 10BASE-T
IEEE 802.3u 100BASE-TX
IEEE 802.3x Full Duplex auto-negotiation and flow control
NWay 10/100 auto-negotiation

(continued)

IEEE 802.1p/Q
 IEEE 802.1Q VLAN Tagging
 RMON
 Microsoft PC97
 Microsoft PC98
 Microsoft PC99
 Net PC
 PCI 2.2
 DMI 2.0 and 2.0s
 ACPI 1.0
 Wired for Management 1.1a, 2.0
 Pre-OS boot protocol support (PXE, BootP/DHCP, NCP, RPL)

3C905B NICs Specifications

Hardware

Bus interface	<i>PCI Local Bus Specification, Revision 2.1</i> 32-bit bus
PCI master	Supports bus master scatter-gather DMAs.
Dimensions	-TX, -TX-M, -TX-NM: Height: 8.57 cm (3.57 in) Length: 12.07 cm (4.75 in) -COMBO Height: 10.033 cm (3.950 in) Length: 17.459 cm (6.874 in) -FX Height: 9.53cm (3.75 in) Length: 12.07cm (4.75 in)
Power requirement	+5 V \pm 5% @ 650 mA maximum

Network Interface

10 Mbps Ethernet 10BASE-T	Ethernet IEEE 802.3 industry standard for a 10 Mbps baseband CSMA/CD local area network
100 Mbps Ethernet 100BASE-TX	Ethernet IEEE 802.3u industry standard for a 100 Mbps baseband CSMA/CD local area network
100 Mbps Ethernet 100BASE-FX	Ethernet IEEE 802.3q industry standard for 100BASE-FX

(continued)

Environment

Operating temperature	32° to 158° F (0° to 70° C)
Storage temperature	-22° to 194° F (-30° to 90° C)
Operating humidity	10 to 90% noncondensing
Storage humidity	10 to 90% noncondensing
Altitude	-984 ft to 9,840 ft (-300 to 3,000 m)

Standards Conformance

IEEE 803.3x flow control
 Microsoft PC98
 PCI 2.1
 DMI 1.0 and 2.0

3C900B NICs Specifications**Hardware**

Memory	4 KB internal RAM
Bus interface	<i>PCI Local Bus Specification, Revision 2.1</i> 32-bit bus
PCI master	Supports bus master scatter-gather DMAs.
Dimensions	-TPO Height: 3.00 in/7.62 cm Length: 4.80 in/12.19 cm -COMBO Height: 3.95 in/10.03 cm Length: 6.82 in/17.32 cm -FL Height: 9.53cm (3.75 in) Length: 12.07cm (4.75 in)
Power requirement	+5 V \pm 5% @ 650 mA maximum

Network Interface

10 Mbps Ethernet 10BASE-T	Ethernet IEEE 802.3 industry standard for a 10 MBPS baseband CSMA/CD local area network.
---------------------------	--

(continued)

Environment

Operating temperature	32° to 158° F (0° to 70° C)
Storage temperature	-22° to 194° F (-30° to 90° C)
Operating humidity	10 to 90% noncondensing
Storage humidity	10 to 90% noncondensing
Altitude	-984 ft to 9,840 ft (-300 to 3,000 m)

Standards Conformance

IEEE 803.3x flow control
Microsoft PC98
PCI 2.1
DMI 1.0 and 2.0

Cabling Requirements

The cable, quality, distance, and connectors must comply with the Electronic Industries Association/Telecommunications Industries Association (EIA/TIA) 568 *Commercial Building Wiring Standard* and the Technical Services Bulletin TSB38 standards.

Twisted-Pair Cable

Twisted-pair cable consists of copper wires surrounded by an insulator. Two wires are twisted together (the twisting prevents interference problems) to form a pair, and the pair forms a circuit that can transmit data. A cable is a bundle of one or more twisted pairs surrounded by an insulator.

Unshielded twisted pair (UTP) is the most commonly used type of twisted-pair cable. Shielded twisted pair (STP) provides protection against crosstalk. Twisted-pair cable is now commonly used in Ethernet, Fast Ethernet, and other network topologies.

The EIA/TIA defines five categories of unshielded twisted-pair cable.

Category	Use
1	Traditional telephone cable.
2	Data transmissions up to 4 MHz.
3	Voice and data transmission up to 25 MHz. The cable typically has four pairs of wires. Category 3 is the most common type of installed cable found in older corporate wiring schemes.
4	Voice and data transmission up to 33 MHz. The cable normally has four pairs of wire. This grade of UTP is not common.
5	Voice and data transmission up to 125 MHz. The cable normally has four pairs of copper wire and three twists per foot. Category 5 UTP is the most popular cable used in new installations today.

10BASE-T Operation

10BASE-T is the Institute of Electrical and Electronics Engineers (IEEE) 802.3 standard for Ethernet signaling over unshielded twisted-pair wire at 10 Mbps.

Ethernet, as the most widely used network protocol, uses 10BASE-T as its primary cabling scheme. Ethernet characteristics include:

- A data rate of 10 Mbps.
- A broadcast architecture.
- A specific media-access control (MAC) scheme.

The 10BASE-T name indicates a signaling speed of 10 Mbps and twisted-pair wiring. *Base* stands for baseband, which denotes a technique for transmitting signals as direct-current pulses rather than modulating them onto separate carrier frequencies.

A wiring topology using 10BASE-T specifies a wiring hub, cable arranged in a star configuration, and unshielded twisted-pair cable. Each node has a separate cable run that must not exceed 100 meters (328 ft) from the node to the hub.

100BASE-TX Operation

100BASE-TX is the IEEE 802.3u standard for Fast Ethernet signaling over Category 5 UTP or STP wire at 100 Mbps.

Based on an extension to the IEEE 802.3 Ethernet specification, Fast Ethernet characteristics include:

- A data rate of 100 Mbps.
- A broadcast architecture.
- A specific media-access control (MAC) scheme.

A wiring topology using 100BASE-TX specifies a wiring hub, cable arranged in a star configuration, and Category 5 UTP or STP wiring. Each node has a separate cable run that must not exceed 100 meters (328 ft) from the node to the hub.

RJ-45 Connector Pin Assignments

The following illustration shows the RJ-45 connector pin assignments for the EtherLink PCI NICs.

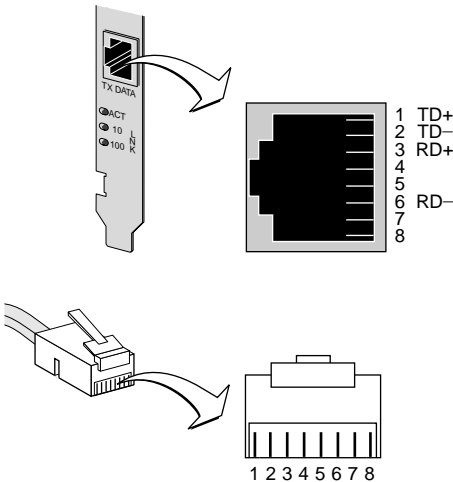

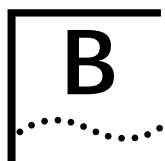

INSTALLING THE DynamicAccess LAN AGENT

Overview

This chapter explains how to install and configure the DynamicAccess LAN agent on a PC running Windows 95, Windows 98, or Windows NT.



For an overview of the DynamicAccess LAN agent, see “[DynamicAccess LAN Agent](#)” in [Chapter 1](#). For detailed information on using, configuring, and troubleshooting the DynamicAccess LAN agent, access the DynamicAccess Technology User Guide on the EtherCD. You can also download it from:

<http://www.3com.com/dynamicaccess>

Client PC Requirements

The DynamicAccess LAN agent can be installed on a PC running Windows 95, Windows 98, Windows NT 4.0, or Windows NT 3.51.



CAUTION: *If you plan to install the DynamicAccess LAN agent on a multiprocessor PC running Windows NT 4.0, Service Pack 4, you must first download and install the appropriate Microsoft patch available at:*

<http://www.3com.com/dynamicaccess/hotfixes>

Failure to install the patch will result in system failure.

The following table lists the minimum client requirements and recommended Microsoft Service Packs (if any) for the version of the DynamicAccess LAN agent that is included on the EtherCD.

Operating System	PC Requirements	Recommended Microsoft Service Pack
Windows 95	486/75 MHz CPU 16 MB RAM (32 MB recommended) 5 MB available hard drive space	Windows 95 OSR2 or Service Pack 1
Windows 98	486/75 MHz CPU 16 MB RAM (32 MB recommended) 5 MB available hard drive space	None
Windows NT 4.0	Pentium/100 MHz CPU 32 MB RAM 5 MB available hard drive space	Service Pack 3
Windows NT 3.51	Pentium/100 MHz CPU 32 MB RAM 5 MB available hard drive space	Service Pack 5

Installing the DynamicAccess LAN Agent

To install the DynamicAccess LAN agent:

- 1 Make sure that the NIC and the network driver are installed on your PC.**

See "[Verifying Successful Installation](#)" in [Chapter 3](#) to confirm that the NIC is properly installed in the PC.

- 2 Start Windows.**

- 3 Insert the *EtherCD* in the CD-ROM drive.**

The *EtherCD* Welcome screen appears.

If the *EtherCD* Welcome screen does not appear, enter the following command from Run option of the Windows Start menu:

```
d:\installs\setup.exe
```

where d:\ represents the letter name of the CD-ROM drive.

- 4 Click *NIC Software*.**
- 5 Click *DynamicAccess Technologies*.**
- 6 Click *DynamicAccess LAN Agent*.**

- 7 Click ***Install DynamicAccess LAN Agent Now***.
- 8 Exit the *EtherCD*, and then exit Windows.
- 9 Restart the PC.



You must restart the PC to complete the installation.

Verifying Successful Installation

After the DynamicAccess LAN agent is installed, the following changes are visible in the Windows Network control panel:

- For each physical NIC installed in the PC, a virtual NIC entry appears in the list of network adapters. All protocols are re-bound to the virtual NIC. The bindings to the physical NIC are still intact.
- A 3Com DynamicAccess LAN agent entry appears as a protocol.
- A 3Com DynamicAccess LAN agent icon is installed in the Windows Control Panel.

Configuring the DynamicAccess LAN Agent

Contact your system administrator about using DynamicAccess technology at your site.



The DynamicAccess LAN agent configuration instructions are intended for network administrators who have experience installing software and using management tools for an Ethernet network.

The instructions in this section are for configuring the DynamicAccess LAN agent on a local PC. You can obtain the complete configuration instructions by accessing the DynamicAccess Software User Guide on the *EtherCD*.

To configure the DynamicAccess LAN agent on a local PC:

1 Double-click the 3Com DynamicAccess icon in the Windows Control Panel.

The Traffic Prioritization tab of the DynamicAccess Setup screen appears.

2 Select the tab containing the information you want to configure.

Traffic Prioritization — Allows you to prioritize applications, which can ease bottlenecks in your network and allow critical applications to take network precedence.

Fast IP — Allows you to enable and configure Fast IP.

Administration — Allows you to set DynamicAccess control panel access, set VLAN options, enable efficient multicast control, and enable the prioritizing of traffic.



For specific instructions on configuring any of the DynamicAccess technology options, click Help on the 3Com DynamicAccess screen or go to:

<http://www.3com.com/dynamicaccess>

Removing DynamicAccess Technology

For instructions on removing the DynamicAccess LAN agent from your PC, see the *DynamicAccess Software User Guide*. This user guide can be accessed on the *EtherCD* or it can be downloaded from:

<http://www.3com.com/dynamicaccess>

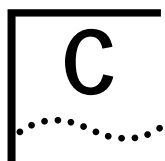

INSTALLING THE 3COM DMI AGENT

Overview

This appendix explains how to install the 3Com Desktop Management Interface (DMI) Agent on your PC.

The 3Com DMI Agent allows any DMI-compatible browser or network management application that supports DMI 2.0 to remotely manage and configure advanced features of an EtherLink PCI NIC.



For detailed information on the 3Com DMI Agent, see the 3Com DMI Agent User Guide included with the 3Com DMI Agent software on the EtherCD.

For more information on DMI, go to:

<http://www.3com.com/managedpc>

About the 3Com DMI Agent

The 3Com DMI Agent allows you to obtain basic NIC information, including:

- Node address
- MAC address
- Driver version

Additionally, depending on the features of your NIC, the 3Com DMI Agent allows you to view and configure advanced NIC features, including:

- Managed PC Boot Agent (MBA) software
- Remote Wake-Up events
- Workgroup keep-alive packet
- Remote system alerts (including heartbeat)

Each PC that contains an EtherLink NIC and the 3Com DMI Agent generates a Management Information Format (MIF) file that contains information about the PC and the NIC. DMI applications use the information from the MIF to manage the PC and the NIC.

The content of the MIF is based on the capabilities of the NIC driver found in the PC. For example, if a NIC with an MBA boot ROM is found, all groups related to the boot ROM are included in the MIF for that particular NIC. This ensures that the network management application does not receive irrelevant information for the NIC.

For a description of each MIF that is supported by the 3Com DMI Agent, see the *3Com DMI Agent User Guide* included with the 3Com DMI Agent software on the *EtherCD*.

System Requirements

This section lists the client PC and network management requirements for installing and using the 3Com DMI Agent.

Client PC Requirements

Your PC requires the following items to use the 3Com DMI Agent:

- DMI Service Provider 2.0 or greater (such as Smart Technologies Service Provider 2.0)
- NDIS 3, 4, or 5 driver
- Windows 95, Windows 98, or Windows NT, using the appropriate Service Pack listed below:
 - Windows 95 Retail Service Pack 1 or OEM Service Release (OSR2)
 - Windows 98 Retail Release
 - Windows NT 4.0 Service Pack 3 or 4
 - Windows NT 3.51 Service Pack 5

Network Management Requirements

Your network management station requires a DMI-compatible browser or a network management application that supports DMI 2.0, such as:

- Hewlett Packard TopTools
- Tivoli Management Suite
- Dell OpenManage
- Compaq Insight Manager Management Station
- Intel LANDesk Client Manager

Installing the 3Com DMI Agent

This section describes how to install the 3Com DMI Agent on a PC running Windows 95, Windows 98, or Windows NT 4.0.

For instructions on how to install the 3Com DMI Agent on a PC running Windows NT 3.51, see the *3Com DMI User Guide* included with the 3Com DMI Agent software on the *EtherCD*.



Before installing the DMI Agent, logon to the PC with an account that has system administration privileges.

To install the 3Com DMI Agent:

- 1 Make sure that the PC meets the requirements listed in [“Client PC Requirements”](#) earlier in this chapter.**
- 2 Make sure that the EtherLink NIC is installed in the PC and is connected to the network.**
- 3 Insert the *EtherCD* in the CD-ROM drive.**

The *EtherCD* Welcome screen appears.

If the *EtherCD* Welcome screen does not appear, enter the following command from Run option of the Windows Start menu:

d:\setup.exe

where d:\ represents the letter name of the CD-ROM drive.

- 4 **Click *NIC Software*.**
- 5 **Click *DynamicAccess Technologies*.**
- 6 **Click *3Com DMI Agent*.**
- 7 **Follow the prompts on the screen.**
- 8 **Restart the PC when prompted.**

To verify successful installation, use a DMI-compatible browser or a network management application that supports DMI 2.0 or 2.0s to verify that the 3Com NIC is present. See the *3Com DMI Agent User Guide* or contact your system administrator for instructions.

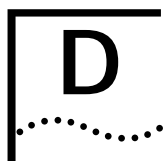

TECHNICAL SUPPORT

3Com provides easy access to technical support information through a variety of services. This appendix describes these services.

Information contained in this appendix is correct at time of publication. For the most recent information, 3Com recommends that you access the 3Com Corporation World Wide Web site.

Online Technical Services

3Com offers worldwide product support 24 hours a day, 7 days a week, through the following online systems:

- World Wide Web site
- 3Com Knowledgebase Web Services
- 3Com FTP site
- 3Com Bulletin Board Service (3Com BBS)
- 3Com FactsSM Automated Fax Service

World Wide Web Site

To access the latest networking information on the 3Com Corporation World Wide Web site enter this URL into your Internet browser:

<http://www.3com.com/>

This service provides access to online support information such as technical documentation and a software library, as well as support options that range from technical education to maintenance and professional services.

3Com Knowledgebase Web Services

This interactive tool contains technical product information compiled by 3Com expert technical engineers around the globe. Located on the World Wide Web at <http://knowledgebase.3com.com>, this service gives all 3Com customers and partners complementary, round-the-clock access to technical information on most 3Com products.

3Com FTP Site

Download drivers, patches, software, and MIBs across the Internet from the 3Com public FTP site. This service is available 24 hours a day, 7 days a week.

To connect to the 3Com FTP site, enter the following information into your FTP client:

- Hostname: **ftp.3com.com**
- Username: **anonymous**
- Password: **<your Internet e-mail address>**



You do not need a user name and password with Web browser software such as Netscape Navigator and Internet Explorer.

3Com Bulletin Board Service

The 3Com BBS contains patches, software, and drivers for 3Com products. This service is available through analog modem or digital modem (ISDN) 24 hours a day, 7 days a week.

Access by Analog Modem

To reach the service by modem, set your modem to 8 data bits, no parity, and 1 stop bit. Call the telephone number nearest you:

Country	Data Rate	Telephone Number
Australia	Up to 14,400 bps	61 2 9955 2073
Brazil	Up to 28,800 bps	55 11 5181 9666
France	Up to 14,400 bps	33 1 6986 6954
Germany	Up to 28,800 bps	4989 62732 188
Hong Kong	Up to 14,400 bps	852 2537 5601

Country	Data Rate	Telephone Number
Italy	Up to 14,400 bps	39 2 27300680
Japan	Up to 14,400 bps	81 3 5977 7977
Mexico	Up to 28,800 bps	52 5 520 7835
P.R. of China	Up to 14,400 bps	86 10 684 92351
Taiwan, R.O.C.	Up to 14,400 bps	886 2 377 5840
U.K.	Up to 28,800 bps	44 1442 438278
U.S.A.	Up to 53,333 bps	1 847 262 6000

Access by Digital Modem

ISDN users can dial in to the 3Com BBS using a digital modem for fast access up to 64 Kbps. To access the 3Com BBS using ISDN, call the following number:

1 847 262 6000

3Com Facts Automated Fax Service

The 3Com Facts automated fax service provides technical articles, diagrams, and troubleshooting instructions on 3Com products 24 hours a day, 7 days a week.

Call 3Com Facts using your Touch-Tone telephone:

1 408 727 7021

Support from Your Network Supplier

If you require additional assistance, contact your network supplier. Many suppliers are authorized 3Com service partners who are qualified to provide a variety of services, including network planning, installation, hardware maintenance, application training, and support services.

When you contact your network supplier for assistance, have the following information ready:

- Product model name, part number, and serial number
- A list of system hardware and software, including revision levels
- Diagnostic error messages
- Details about recent configuration changes, if applicable

If you are unable to contact your network supplier, see the following section on how to contact 3Com.

Support from 3Com

If you are unable to obtain assistance from the 3Com online technical resources or from your network supplier, 3Com offers technical telephone support services. To find out more about your support options, call the 3Com technical telephone support phone number at the location nearest you.

When you contact 3Com for assistance, have the following information ready:

- Product model name, part number, and serial number
- A list of system hardware and software, including revision levels
- Diagnostic error messages
- Details about recent configuration changes, if applicable

Here is a list of worldwide technical telephone support numbers:

Country	Telephone Number
Asia Pacific Rim	
Australia	1 800 678 515
Hong Kong	800 933 486
India	+61 2 9937 5085
Indonesia	001 800 61 009
Japan	0031 61 6439
Malaysia	1800 801 777
New Zealand	0800 446 398
Pakistan	+61 2 9937 5085
Philippines	1235 61 266 2602
P.R. of China	10800 61 00137 or 021 6350 1590
Singapore	800 6161 463
S. Korea	
From anywhere in S. Korea:	00798 611 2230
From Seoul:	(0)2 3455 6455
Taiwan, R.O.C.	0080 611 261
Thailand	001 800 611 2000
Europe	
From anywhere in Europe, call:	+31 (0)30 6029900 phone +31 (0)30 6029999 fax

Country	Telephone Number
Europe, South Africa, and Middle East	
From the following countries, you may use the toll-free numbers:	
Austria	0800 297468
Belgium	0800 71429
Denmark	800 17309
Finland	0800 113153
France	0800 917959
Germany	0800 1821502
Hungary	00800 12813
Ireland	1800 553117
Israel	1800 9453794
Italy	1678 79489
Netherlands	0800 0227788
Norway	800 11376
Poland	00800 3111206
Portugal	0800 831416
South Africa	0800 995014
Spain	900 983125
Sweden	020 795482
Switzerland	0800 55 3072
U.K.	0800 966197
Latin America	
Argentina	AT&T +800 666 5065
Brazil	0800 13 3266
Chile	1230 020 0645
Colombia	98012 2127
Mexico	01 800 CARE (01 800 2273)
Peru	AT&T +800 666 5065
Puerto Rico	800 666 5065
Venezuela	AT&T +800 666 5065
North America	
	1 800 NET 3Com (1 800 638 3266)
	Enterprise Customers: 1 800 876-3266

Returning Products for Repair

Before you send a product directly to 3Com for repair, you must first obtain an authorization number. Products sent to 3Com without authorization numbers will be returned to the sender unopened, at the sender's expense.

To obtain an authorization number, call or fax:

Country	Telephone Number	Fax Number
Asia, Pacific Rim	+65 543 6500	+65 543 6348
Europe, South Africa, and Middle East	+31 30 6029900	+31 30 6029999
Latin America	1 408 326 2927	1 408 326 3355

From the following countries, you may call the toll-free numbers;
select option 2 and then option 2:

Austria	0800 297468	
Belgium	0800 71429	
Denmark	800 17309	
Finland	0800 113153	
France	0800 917959	
Germany	0800 1821502	
Hungary	00800 12813	
Ireland	1800553117	
Israel	1800 9453794	
Italy	1678 79489	
Netherlands	0800 0227788	
Norway	800 11376	
Poland	00800 3111206	
Portugal	0800 831416	
South Africa	0800 995014	
Spain	900 983125	
Sweden	020 795482	
Switzerland	0800 55 3072	
U.K.	0800 966197	
U.S.A. and Canada	1 800 NET 3Com (1 800 638 3266)	1 408 326 7120 (not toll-free)
	Enterprise Customers: 1 800 876 3266	

INDEX

Numbers

- 10 LNK LED
 - picture of 13, 15
 - troubleshooting with 73
- 100 LNK LED
 - picture of 13
 - troubleshooting with 74
- 100BASE-FX
 - cable requirements 33
 - link LED 74
- 100BASE-TX
 - cable requirements 30
 - link LED 13, 74
 - operation 84
- 10BASE2
 - cable requirements 31
 - link LED 74
- 10BASE5
 - cable requirements 32
 - link LED 74
- 10BASE-FL
 - cable requirements 34
 - link LED 15
- 10BASE-T
 - cable requirements 30
 - link LED 13, 15, 73
 - operation 83
- 3C900 NIC, installing in Windows 98 22
- 3C900B-COMBO NIC
 - features 16
 - picture of 15
 - specifications 81
- 3C900B-FL NIC
 - features 16
 - picture of 15
 - specifications 81
- 3C900B-TPO NIC
 - features 16
 - picture of 15
 - specifications 81
- 3C905 NIC, installing in Windows 98 22
- 3C905B-COMBO NIC
 - features 14
 - picture of 14
 - specifications 80
- 3C905B-FX NIC
 - features 14
 - picture of 14
 - specifications 80
- 3C905B-TX NIC
 - features 14
 - picture of 13
 - specifications 80
- 3C905B-TX-M NIC
 - features 14
 - picture of 13
 - specifications 80
- 3C905B-TX-NM NIC
 - features 14
 - picture of 13
 - specifications 80
- 3C905C-TX-M NIC
 - features 12
 - picture of 11
 - specifications 79
- 3C90X.LAN file 51
- 3Com bulletin board service (3Com BBS) 94
- 3Com Configuration and Diagnostics Program for DOS 59
- 3Com DMI Agent
 - client PC requirements 90
 - installing 91
 - network management requirements 91
 - overview 89
- 3Com icon, in Windows system tray
 - removing 78
 - showing 78
- 3Com Knowledgebase Web Services 94
- 3Com NIC Diagnostics program
 - installing 44
 - starting 58
- 3Com support services, accessing 65
- 3Com URL 93

3ComFacts 95
50-ohm terminator 31

A

accessing Help 66
ACT (activity) LED
 picture of 12
 troubleshooting with 74
activity on the network, verifying 77,
78
alerts, remote system
 overview 20
 requirements 20
AUI port
 connecting to network 32
 specifications 32
AUTOEXEC.NCF file 55

B

BNC port
 connecting to network 31
 specifications 31
boot ROM, MBA
 booting from network 61
 default setting 58
 enabling or disabling 61
 overview 18
bulletin board service 94

C

cabling
 fiber-optic 33, 34
 Remote Wake-Up 17
 requirements 82
 specifications
 AUI port 32
 BNC port 31
 RJ-45 port 30
 SC port 33
 ST port 34
 thick Ethernet coaxial 32
 thin Ethernet coaxial 31
 troubleshooting 68
 unshielded twisted-pair (UTP) 30
carrier sense lost, viewing 77
cleaning up a failed installation 67
client driver, Novell NetWare 49
coaxial cable
 thick 32

 thin 31
collisions, viewing 77
compliance, Year 2000 10
configuring
 DynamicAccess LAN agent 87
 Managed PC Boot Agent
 (MBA) 60
 NIC 59
conventions
 text, About This Guide 10
CRC errors, viewing 77

D

Desktop Management Interface (DMI),
 overview 19
diagnostics tests, running 75
diskettes
 creating 23
 obtaining 22
DMI (Desktop Management Interface),
 overview 19
DOS
 3Com Configuration and
 Diagnostics Program 59
 Novell client driver, installing 49
drivers
 NetWare client, installing 49
 NetWare server, installing 51
 Windows 95, installing 38
 Windows 98, installing 39, 43
 Windows NT
 version 3.51, installing 42
 version 4.0, installing 41
duplex mode
 configuring 59
 default setting 57
DynamicAccess LAN agent
 administration 88
 client requirements 85
 configuring 87
 efficient multicast control 20
 Fast IP 20
 features 19
 Help, accessing 88
 installing 86
 overview 19
 removing 88
 traffic prioritization 20
 verifying installation 87

E

- efficient multicast control
 - configuring 88
 - overview 20
- EIA/TIA 568 standards 82
- Ethernet cable
 - fiber-optic 33, 34
 - thick coaxial 32
 - thin coaxial 31
- Ethernet protocol, characteristics of 83
- excessive collisions, viewing 77
- external transceiver 32

F

- Fast Ethernet protocol, characteristics of 84
- Fast IP
 - configuring 88
 - overview 20
- fax service (3ComFacts) 95
- fiber-optic cable 33, 34
- frame alignment errors, viewing 77
- frames, sent and received, viewing 78
- frequently asked questions 66
- full-duplex 57

H

- half-duplex 57
- Help system, accessing 66

I

- installation
 - 3Com DMI Agent 91
 - connecting to the network 29
 - diskettes
 - creating 23
 - obtaining 22
 - DynamicAccess LAN agent 86
 - multiple NICs 45, 53
 - overview 21
 - preinstallation program,
 - running 24
 - Remote Wake-Up cable 28
 - verifying 43
- installation steps 21
- installing drivers

- NetWare client for DOS,
 - Windows 3.1x, and Windows for Workgroups 49
- NetWare server 51
- Windows 95 38
- Windows 98 39
- Windows NT 3.51 42
- Windows NT 4.0 41
- installing multiple NICs
 - NetWare server 53
 - Windows 95 45
 - Windows 98 45
 - Windows NT 4.0 47
- intelligent auto install software requirements 50
- running 50
- using 49

K

- keep-alive packet, workgroup 20
- Knowledgebase topics
 - accessing through diagnostics program 66
 - accessing through Web site 65

L

- late collisions, viewing 77
- LEDs
 - description 73
 - picture of 11, 13, 15
 - troubleshooting 74
- link speed, checking 78

M

- Managed PC Boot Agent (MBA) software
 - configuring 60
 - network booting 61
 - overview 18
- media type
 - configuring 59
 - default setting 58
- MIBs 94
- multiple collisions, viewing 77
- multiple NIC installations
 - NetWare server 53
 - Windows 95/98 46
 - Windows NT 4.0 47

N

- NetWare
 - NLMs 51
 - server driver 51
- Network Loadable Modules (NLMs) 51
- network
 - activity, verifying 77, 78
 - booting 61
 - cable, maximum length 31, 32, 33, 34
 - connecting to 29
 - connection, testing 75
 - statistics, viewing 77
 - test, running 75
- network connection, troubleshooting 68
- network driver optimization
 - configuring 59
 - default setting 57
 - description 57
- network supplier support 95
- NIC
 - diagnostic tests 75
 - driver installation 49
 - software, removing 70
 - test, running 76
- Novell NetWare
 - client driver 49
 - multiple NICs 53
 - server driver 51

O

- online Help 66
- online Knowledgebase 65
- online technical services 93

P

- packets, viewing 77, 78
- PC requirements 21
- PCI slot, identifying 26
- pin assignments 84
- preinstallation program, running 24

R

- receive overruns, viewing 77
- received frames, viewing 78
- red X in Windows Device Manager 67
- release notes, accessing 66
- remote monitoring (RMON) 19

- Remote Wake-Up
 - cable
 - connecting 28
 - obtaining 17
 - multiple NIC Installations 18
 - overview 17
 - requirements 17
 - test, running 76
 - troubleshooting 69
- removing DynamicAccess LAN agent 88
- removing NIC software 70
- requirements
 - 3Com DMI Agent 90
 - cabling 82
 - DynamicAccess LAN agent 85
 - PC 21
 - Remote Wake-Up 17
- returning products for repair 97
- RJ-45 port
 - connector pin assignments 84
- RMON (remote monitoring) 19

S

- SC (fiber) port
 - connecting to network 33
 - specifications 33, 34
- sent frames, viewing 78
- server driver, Novell NetWare 51
- shielded twisted-pair (STP) cable 82
- single collisions, viewing 77
- software
 - 3Com NIC Diagnostics program, installing 44
 - NetWare drivers, installing 49
 - removing 70
 - updating 45
 - Windows network drivers, installing 37
- specifications
 - cabling
 - AUI port 32
 - BNC port 31
 - RJ-45 port 30
 - SC port 33
 - ST port 34
 - specifications, NIC 79
- SQE errors, viewing 77
- statistics, network, viewing 77
- STP wire 82
- support databases, accessing 65

T

- technical support
 - 3Com Knowledgebase Web Services 94
 - 3Com URL 93
 - bulletin board service 94
 - fax service 95
 - network suppliers 95
 - product repair 97
- test
 - Network 75
 - NIC 76
 - Remote Wake-Up 76
- thick Ethernet coaxial cable 32
- thin Ethernet coaxial cable 31
- traffic prioritization
 - configuring 88
 - overview 20
- transmit deferrals, viewing 77
- transmit underruns, viewing 77
- troubleshooting
 - cable 68
 - cleaning up a failed installation 67
 - error messages 67
 - LEDs 74
 - MBA boot ROM 60
 - network connection 68
 - NIC installation 67
 - Remote Wake-Up 69
- twisted-pair cable, description 82

U

- uninstalling the NIC 70
- unshielded twisted-pair (UTP)
 - cable 30, 82
- updating
 - network driver 45
 - NIC diagnostic program 45
- upgrading Windows 95 to
 - Windows 98 22
- URL 93

V

- verifying successful installation 43

W

- Windows 3.1x, Novell client driver, installing 49
- Windows 95
 - multiple NIC installations 46
 - removing NIC software 70
 - upgrading to Windows 98 22
 - verifying installation 43
- Windows 98
 - installing driver (NDIS 5) 43
 - multiple NIC installations 46
 - removing NIC software 70
 - upgrading from Windows 95 22
 - verifying installation 43
- Windows for Workgroups, Novell client driver, installing 49
- Windows NT 3.51
 - installing driver 42
 - removing NIC software 71
 - verifying installation 43
- Windows NT 4.0
 - installing driver 41
 - multiple NIC installations 47
 - removing NIC software 71
 - verifying installation 43
- Windows system tray, 3Com icon 78
- workgroup keep-alive packet 20
- World Wide Web (WWW) 93, 94

Y

- Year 2000 compliance 10
- yellow exclamation point (!) in
 - Windows Device Manager 67

3Com Corporation LIMITED WARRANTY

This warranty applies to Customers located in the United States, Australia, Canada (except Quebec), Ireland, New Zealand, U.K, and other English language countries, and countries for which a translation into the local language is not provided.

EtherLink PCI Network Interface Cards

HARDWARE

3Com warrants to the end user ("Customer") that this hardware product to be free from defects in workmanship and materials, under normal use and service, for the following length of time from the date of purchase from 3Com or its authorized reseller:

Lifetime

Spare Parts and Spares Kits 90 days

3Com's sole obligation under this express warranty shall be, at 3Com's option and expense, to repair the defective product or part, deliver to Customer an equivalent product or part to replace the defective item, or if neither of the two foregoing options is reasonably available, 3Com may, in its sole discretion, refund to Customer the purchase price paid for the defective product. All products that are replaced will become the property of 3Com. Replacement products may be new or reconditioned. 3Com warrants any replaced or repaired product or part for ninety (90) days from shipment, or the remainder of the initial warranty period, whichever is longer.

SOFTWARE

3Com warrants to Customer that each software program licensed from it will perform in substantial conformance to its program specifications, for a period of ninety (90) days from the date of purchase from 3Com or its authorized reseller. 3Com warrants the media containing software against failure during the warranty period. No updates are provided. 3Com's sole obligation under this express warranty shall be, at 3Com's option and expense, to refund the purchase price paid by Customer for any defective software product, or to replace any defective media with software which substantially conforms to applicable 3Com published specifications. Customer assumes responsibility for the selection of the appropriate applications program and associated reference materials. 3Com makes no warranty or representation that its software products will meet Customer's requirements or work in combination with any hardware or applications software products provided by third parties, that the operation of the software products will be uninterrupted or error free, or that all defects in the software products will be corrected. For any third party products listed in the 3Com software product documentation or specifications as being compatible, 3Com will make reasonable efforts to provide compatibility, except where the non-compatibility is caused by a "bug" or defect in the third party's product or from use of the software product not in accordance with 3Com's published specifications or user manual.

THIS 3COM PRODUCT MAY INCLUDE OR BE BUNDLED WITH THIRD PARTY SOFTWARE. THE USE OF WHICH IS GOVERNED BY A SEPARATE END USER LICENSE AGREEMENT. THIS 3COM WARRANTY DOES NOT APPLY TO SUCH THIRD PARTY SOFTWARE. FOR THE APPLICABLE WARRANTY, PLEASE REFER TO THE END USER LICENSE AGREEMENT GOVERNING THE USE OF SUCH SOFTWARE.

YEAR 2000 WARRANTY

In addition to the Hardware Warranty and Software Warranty stated above, 3Com warrants that each product sold or licensed to Customer on and after January 1, 1998 that is date sensitive will continue performing properly with regard to such date data on and after January 1, 2000, provided that all other products used by Customer in connection or combination with the 3Com product, including hardware, software, and firmware, accurately exchange date data with the 3Com product, with the exception of those products identified at 3Com's Web site, <http://www.3com.com/products/yr2000.html>, as not meeting this standard. If it appears that any product that is stated to meet this standard does not perform properly with regard to such date data on and after January 1, 2000, and Customer notifies 3Com before the later of April 1, 2000, or ninety (90) days after purchase of the product from 3Com or its authorized reseller, 3Com shall, at its option and expense, provide a software update which would effect the proper performance of such product, repair such product, deliver to Customer an equivalent product to replace such product, or if none of the foregoing is feasible, refund to Customer the purchase price paid for such product.

Any software update or replaced or repaired product will carry a Year 2000 Warranty for ninety (90) days after purchase or until April 1, 2000, whichever is later.

OBTAINING WARRANTY SERVICE

Customer must contact a 3Com Corporate Service Center or an Authorized 3Com Service Center within the applicable warranty period to obtain warranty service authorization. Dated proof of purchase from 3Com or its authorized reseller may be required. Products returned to 3Com's Corporate Service Center must be pre-authorized by 3Com with a Return Material Authorization (RMA) number or User Service Order (USO) number marked on the outside of the package, and sent prepaid and packaged appropriately for safe shipment, and it is recommended that they be insured or sent by a method that provides for tracking of the package. Responsibility for loss or damage does not transfer to 3Com until the returned item is received by 3Com. The repaired or replaced item will be shipped to Customer, at 3Com's expense, not later than thirty (30) days after 3Com receives the defective product.

3Com shall not be responsible for any software, firmware, information, or memory data of Customer contained in, stored on, or integrated with any products returned to 3Com for repair, whether under warranty or not.

Dead- or Defective-on-Arrival. In the event a product completely fails to function or exhibits a defect in materials or workmanship within the first forty-eight (48) hours of installation but no later than thirty (30) days after the date of purchase, and this is verified by 3Com, it will be considered dead- or defective-on-arrival (DOA) and a replacement shall be provided by advance replacement. The replacement product will normally be shipped not later than three (3) business days after 3Com's verification of the DOA product, but may be delayed due to export or import procedures. The shipment of advance replacement products is subject to local legal requirements and may not be available in all locations. When an advance replacement is provided and Customer fails to return the original product to 3Com within fifteen (15) days after shipment of the replacement, 3Com will charge Customer for the replacement product, at list price.

INCLUDED SERVICES

Telephone Support, with coverage for basic troubleshooting only, will be provided for lifetime of the product, on a commercially reasonable efforts basis. Telephone support is available from 3Com only if Customer purchased this product directly from 3Com, or if Customer's reseller is unable to provide telephone support. Please refer to the Technical Support appendix in the user guide for telephone numbers.

3Com's Web and Bulletin Board Service are available at no charge, and provide software and firmware upgrades, a bug list, and technical information about 3Com products.

WARRANTIES EXCLUSIVE

IF A 3COM PRODUCT DOES NOT OPERATE AS WARRANTED ABOVE, CUSTOMER'S SOLE REMEDY FOR BREACH OF THAT WARRANTY SHALL BE REPAIR, REPLACEMENT, OR REFUND OF THE PURCHASE PRICE PAID, AT 3COM'S OPTION. TO THE FULL EXTENT ALLOWED BY LAW, THE FOREGOING WARRANTIES AND REMEDIES ARE EXCLUSIVE AND ARE IN LIEU OF ALL OTHER WARRANTIES, TERMS, OR CONDITIONS, EXPRESS OR IMPLIED, EITHER IN FACT OR BY OPERATION OF LAW, STATUTORY OR OTHERWISE, INCLUDING WARRANTIES, TERMS, OR CONDITIONS OF MERCHANTABILITY, FITNESS FOR A PARTICULAR PURPOSE, SATISFACTORY QUALITY, CORRESPONDENCE WITH DESCRIPTION, AND NON-INFRINGEMENT, ALL OF WHICH ARE EXPRESSLY DISCLAIMED. 3COM NEITHER ASSUMES NOR AUTHORIZES ANY OTHER PERSON TO ASSUME FOR IT ANY OTHER LIABILITY IN CONNECTION WITH THE SALE, INSTALLATION, MAINTENANCE OR USE OF ITS PRODUCTS.

3COM SHALL NOT BE LIABLE UNDER THIS WARRANTY IF ITS TESTING AND EXAMINATION DISCLOSE THAT THE ALLEGED DEFECT OR MALFUNCTION IN THE PRODUCT DOES NOT EXIST OR WAS CAUSED BY CUSTOMER'S OR ANY THIRD PERSON'S MISUSE, NEGLIGENCE, IMPROPER INSTALLATION OR TESTING, UNAUTHORIZED ATTEMPTS TO OPEN, REPAIR OR MODIFY THE PRODUCT, OR ANY OTHER CAUSE BEYOND THE RANGE OF THE INTENDED USE, OR BY ACCIDENT, FIRE, LIGHTNING, POWER CUTS OR OUTAGES, OTHER HAZARDS, OR ACTS OF GOD.

LIMITATION OF LIABILITY

TO THE FULL EXTENT ALLOWED BY LAW, 3COM ALSO EXCLUDES FOR ITSELF AND ITS SUPPLIERS ANY LIABILITY, WHETHER BASED IN CONTRACT OR TORT (INCLUDING NEGLIGENCE), FOR INCIDENTAL, CONSEQUENTIAL, INDIRECT, SPECIAL, OR PUNITIVE DAMAGES OF ANY KIND, OR FOR LOSS OF REVENUE OR PROFITS, LOSS OF BUSINESS, LOSS OF INFORMATION OR DATA, OR OTHER FINANCIAL LOSS ARISING OUT OF OR IN CONNECTION WITH THE SALE, INSTALLATION, MAINTENANCE, USE,

PERFORMANCE, FAILURE, OR INTERRUPTION OF ITS PRODUCTS, EVEN IF 3COM OR ITS AUTHORIZED RESELLER HAS BEEN ADVISED OF THE POSSIBILITY OF SUCH DAMAGES, AND LIMITS ITS LIABILITY TO REPAIR, REPLACEMENT, OR REFUND OF THE PURCHASE PRICE PAID, AT 3COM'S OPTION. THIS DISCLAIMER OF LIABILITY FOR DAMAGES WILL NOT BE AFFECTED IF ANY REMEDY PROVIDED HEREIN SHALL FAIL OF ITS ESSENTIAL PURPOSE.

DISCLAIMER

Some countries, states, or provinces do not allow the exclusion or limitation of implied warranties or the limitation of incidental or consequential damages for certain products supplied to consumers, or the limitation of liability for personal injury, so the above limitations and exclusions may be limited in their application to you. When the implied warranties are not allowed to be excluded in their entirety, they will be limited to the duration of the applicable written warranty. This warranty gives you specific legal rights which may vary depending on local law.

GOVERNING LAW

This Limited Warranty shall be governed by the laws of the State of California, U.S.A. excluding its conflicts of laws principles and excluding the United Nations Convention on Contracts for the International Sale of Goods.

3Com Corporation

5400 Bayfront Plaza

P.O. Box 58145

Santa Clara, CA 95052-8145

(408) 326-5000

FCC CLASS B STATEMENT

This device complies with Part 15 of the FCC Rules. Operation is subject to the following two conditions:

- 1 This device may not cause harmful interference, and
- 2 This device must accept any interference received, including interference that may cause undesired operation.

WARNING: This equipment has been tested and found to comply with the limits for a Class B digital device, pursuant to Part 15 of the FCC Rules. These limits are designed to provide reasonable protection against harmful interference in a residential installation. This equipment generates, uses and can radiate radio frequency energy and, if not installed and used in accordance with the instructions, may cause harmful interference to radio communications. However, there is no guarantee that interference will not occur in a particular installation. If this equipment does cause harmful interference to radio or television reception, which can be determined by turning the equipment off and on, the user is encouraged to try to correct the interference by one or more of the following measures:

- Reorient or relocate the receiving antenna.
- Increase the separation between the equipment and receiver.
- Connect the equipment into an outlet on a circuit different from the one which the receiver is connected to.
- Consult the dealer or an experienced radio/TV technician for help.

The user may find the following booklet prepared by the Federal Communications Commission helpful:

The Interference Handbook

This booklet is available from the U.S. Government Printing Office, Washington, D.C. 20402.
Stock No. 004-000-00345-4.

Tested to comply with the FCC Standards for home and office use.

NOTE: In order to maintain compliance with the limits of a Class B digital device, 3Com requires that you use quality interface cables when connecting to this device. Changes or modifications not expressly approved by 3Com could void the user's authority to operate this equipment. Refer to the manual for specifications on cabling types.

FCC DECLARATION OF CONFORMITY

We declare under our sole responsibility that the

Model:	Description:
3C905C-TX-M	EtherLink 10/100 PCI for Complete PC Management Network Interface Card
3C905B-TX	EtherLink 10/100 PCI Network Interface Card
3C905B-TX-M	EtherLink 10/100 PCI Network Interface Card
3C905B-TX-NM	EtherLink 10/100 PCI Network Interface Card
3C905B-COMBO	EtherLink 10/100 PCI Network Interface Card
3C905B-FX	EtherLink 100 PCI Fiber Network Interface Card
3C900B-TPO	EtherLink 10 PCI Network Interface Card
3C900B-COMBO	EtherLink 10 PCI Network Interface Card
3C900B-FL	EtherLink 10 PCI Fiber Network Interface Card

to which this declaration relates, is in conformity with the following standards or other normative documents:

- ANSI C63.4-1992 Methods of Measurement
- Federal Communications Commission 47 CFR Part 15, subpart B
15.107 (e) Class B Conducted Limits
15.109 (g) Class B Radiated Emissions Limits

3Com Corporation, 5400 Bayfront Plaza, P.O. Box 58145, Santa Clara, CA 95052-8145 (408) 326-5000

INDUSTRY CANADA CLASS B EMISSION COMPLIANCE STATEMENT

This Class B digital apparatus complies with Canadian ICES-003.

AVIS DE CONFORMITÉ À LA RÉGLEMENTATION D'INDUSTRIE CANADA

Cet appareil numérique de la classe B est conforme à la norme NMB-003 du Canada.

VCCI CLASS B STATEMENT

この装置は、情報処理装置等電波障害自主規制協議会（VCCI）の基準に基づくクラスB情報技術装置です。この装置は、家庭環境で使用することを目的としていますが、この装置がラジオやテレビジョン受信機に近接して使用されると、受信障害を引き起こすことがあります。
取扱説明書に従って正しい取り扱いをして下さい。

This is a Class B product based on the standard of the Voluntary Control Council for Interference from Information Technology Equipment (VCCI). If this is used near a radio or television receiver in a domestic environment, it may cause radio interference. Install and use the equipment according to the instruction manual.

3COM END USER SOFTWARE LICENSE AGREEMENT

IMPORTANT: Read Before Using This Product

YOU SHOULD CAREFULLY READ THE FOLLOWING TERMS AND CONDITIONS BEFORE INSTALLING AND USING, THE USE OF WHICH IS LICENSED BY 3COM CORPORATION ("3COM") TO ITS CUSTOMERS FOR THEIR USE ONLY AS SET FORTH BELOW. INSTALLING OR USING ANY PART OF THE SOFTWARE INDICATES THAT YOU ACCEPT THESE TERMS AND CONDITIONS. IF YOU DO NOT AGREE TO THE TERMS AND CONDITIONS OF THIS AGREEMENT, DO NOT INSTALL OR USE THE SOFTWARE. YOU SHOULD RETURN THE ENTIRE PRODUCT WITH THE SOFTWARE UNUSED TO THE SUPPLIER WHERE YOU OBTAINED IT.

LICENSE: 3Com grants you a nonexclusive, nontransferable (except as specified herein) license to use the accompanying software program(s) in executable form (the "Software") and accompanying documentation (the "Documentation"), subject to the terms and restrictions set forth in this Agreement. You are not permitted to lease, rent, distribute or sublicense (except as specified herein) the Software or Documentation or to use the Software or Documentation in a time-sharing arrangement or in any other unauthorized manner. Further, no license is granted to you in the human readable code of the Software (source code). Except as provided below, this Agreement does not grant you any rights to patents, copyrights, trade secrets, trademarks, or any other rights with respect to the Software or Documentation.

Subject to the restrictions set forth herein, the Software is licensed to be used on any workstation or any network server owned by or leased to you, for your internal use, provided that the Software is used only in connection with a 3Com adapter. You may reproduce and provide one (1) copy of the Software and Documentation for each such workstation or network server on which the Software is used as permitted hereunder. Otherwise, the Software and Documentation may be copied only as essential for backup or archive purposes in support of your use of the Software as permitted hereunder. Each copy of the Software and Documentation must contain 3Com's and its licensors' proprietary rights and copyright notices in the same form as on the original. You agree not to remove or deface any portion of any legend provided on any licensed program or documentation delivered to you under this Agreement.

ASSIGNMENT; NO REVERSE ENGINEERING: You may transfer the Software, Documentation and the licenses granted herein to another party in the same country in which you obtained the Software and Documentation if the other party agrees in writing to accept and be bound by the terms and conditions of this Agreement. If you transfer all copies of the Software and Documentation to the party or you must destroy any copies not transferred. Except as set forth above, you may not assign or transfer your rights under this Agreement.

Modification, reverse engineering, reverse compiling, or disassembly of the Software is expressly prohibited. However, if you are a European Community ("EC") resident, information necessary to achieve interoperability of the Software with other programs within the meaning of the EC Directive on the Legal Protection of Computer Programs is available to you from 3Com upon written request.

EXPORT RESTRICTIONS: You agree that you will not export or re-export the Software, Documentation or other technical data received hereunder (or any copies thereof) (collectively "Technical Data") or any products utilizing the Technical Data in violation of any applicable laws or regulations of the United States or the country in which you obtained them or where you reside. **In addition, the Technical Data covered by this Agreement may contain data encryption code which is unlawful to export or transfer from the United States or Canada without an approved US Department of Commerce export license and/or appropriate foreign export or import license.** You are responsible for obtaining any licenses to export, re-export or import the Technical Data. In addition to the above, Technical Data may not be used, exported or re-exported (i) into or to a national or resident of any country to which the U.S. has embargoed goods; or (ii) to any one on the U.S. Treasury Department's list of Specially Designated Nationals or the U.S. Commerce Department's Table of Denial Orders.

TRADE SECRETS; TITLE: You acknowledge and agree that the structure, sequence and organization of the Software are the valuable trade secrets of 3Com and its suppliers. You agree to hold such trade secrets in confidence. You further acknowledge and agree that ownership of, and title to, the Software and Documentation and all subsequent copies thereof regardless of the form or media are held by 3Com and its suppliers.

UNITED STATES GOVERNMENT LEGENDS: The Software, Documentation and any other technical data provided hereunder is commercial in nature and developed solely at private expense. The Software is delivered as "Commercial Computer Software" as defined in DFARS 252.227-7014 (June 1995) or as a commercial item as defined in FAR 2.101(a) and as such is provided with only such rights as are provided in this Agreement, which is 3Com's standard commercial license for the Software. Technical data is provided with limited rights only as provided in DFAR 252.227-7015 (Nov. 1995) or FAR 52.227-14 (June 1987), whichever is applicable.

TERM AND TERMINATION: This Agreement and license will expire fifty (50) years from the date that you install the Software and Documentation, if it is not terminated earlier. You may terminate it at any time by destroying the Software and Documentation together with all copies and merged portions in any form. It will also terminate immediately if you fail to comply with any term or condition of this Agreement. Upon such termination you agree to destroy the Software and Documentation, together with all copies and merged portions in any form.

LIMITED WARRANTIES AND LIMITATION OF LIABILITY: All warranties and limitations of liability applicable to the Software are as stated on the Limited Warranty Card or in the product manual, whether in paper or electronic form, accompanying the Software. Such warranties and limitations of liability are incorporated herein in their entirety by this reference.

GOVERNING LAW: This Agreement shall be governed by the laws of the State of California, U.S.A. excluding its conflicts of laws principles and excluding the United Nations Convention on Contracts for the International Sale of Goods.

SEVERABILITY: In the event any provision of this Agreement is found to be invalid, illegal or unenforceable, the validity, legality and enforceability of any of the remaining provisions shall not in any way be affected or impaired and a valid, legal and enforceable provision of similar intent and economic impact shall be substituted therefor.

ENTIRE AGREEMENT: This Agreement sets forth the entire understanding and agreement between you and 3Com and supersedes all prior agreements, whether written or oral, with respect to the Software and Documentation, and may be amended only in a writing signed by both parties.

Should you have any questions concerning this Agreement or if you desire to contact 3Com for any reason, please contact the 3Com subsidiary serving your country, or write: 3Com Corporation, Customer Support Information, 5400 Bayfront Plaza, Santa Clara, CA 95052

3Com is a registered trademark of 3Com Corporation.

3Com Corporation

5400 Bayfront Plaza, P.O. Box 58145
Santa Clara, CA 95052-8145
(408) 326-5000

© Copyright 1999, 3Com Corporation. All rights reserved

PRODUCT REGISTRATION

To ensure the very best service and support, register your 3Com product now.

International Customers: Visit <http://www.3com.com/productreg> to register.

U.S. Customers: Complete and mail the attached registration card, or visit <http://www.3com.com/productreg> to register.